

HEXFET® Power MOSFET

- Surface Mount
- Available in Tape & Reel
- Dynamic dv/dt Rating
- Repetitive Avalanche Rated
- P-Channel
- Fast Switching
- Ease of Paralleling

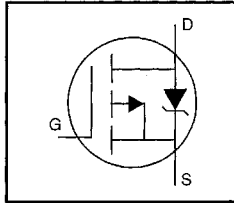

$$V_{DSS} = -200V$$

$$R_{DS(on)} = 0.50\Omega$$

$$I_D = -11A$$

Description

Third Generation HEXFETs from International Rectifier provide the designer with the best combination of fast switching, ruggedized device design, low on-resistance and cost-effectiveness.

The SMD-220 is a surface mount power package capable of accommodating die sizes up to HEX-4. It provides the highest power capability and the lowest possible on-resistance in any existing surface mount package. The SMD-220 is suitable for high current applications because of its low internal connection resistance and can dissipate up to 2.0W in a typical surface mount application.

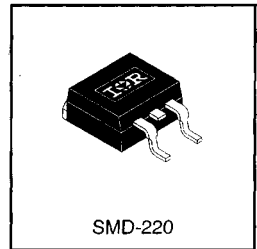

DATA SHEETS

Absolute Maximum Ratings

| | Parameter | Max. | Units |
|---------------------------|--|-----------------------|-------|
| $I_D @ T_C = 25^\circ C$ | Continuous Drain Current, $V_{GS} @ -10 V$ | -11 | A |
| $I_D @ T_C = 100^\circ C$ | Continuous Drain Current, $V_{GS} @ -10 V$ | -6.8 | |
| I_{DM} | Pulsed Drain Current ① | -44 | |
| $P_D @ T_C = 25^\circ C$ | Power Dissipation | 125 | W |
| $P_D @ T_A = 25^\circ C$ | Power Dissipation (PCB Mount)** | 3.0 | |
| | Linear Derating Factor | 1.0 | W/°C |
| | Linear Derating Factor (PCB Mount)** | 0.025 | |
| V_{GS} | Gate-to-Source Voltage | ± 20 | V |
| E_{AS} | Single Pulse Avalanche Energy ② | 700 | mJ |
| I_{AR} | Avalanche Current ① | -11 | A |
| E_{AR} | Repetitive Avalanche Energy ① | 13 | mJ |
| dv/dt | Peak Diode Recovery dv/dt ③ | -5.0 | V/ns |
| T_J, T_{STG} | Junction and Storage Temperature Range | -55 to +150 | °C |
| | Soldering Temperature, for 10 seconds | 300 (1.6mm from case) | |

Thermal Resistance

| | Parameter | Min. | Typ. | Max. | Units |
|-----------------|-----------------------------------|------|------|------|-------|
| $R_{\theta JC}$ | Junction-to-Case | — | — | 1.0 | °C/W |
| $R_{\theta JA}$ | Junction-to-Ambient (PCB mount)** | — | — | 40 | |
| $R_{\theta JA}$ | Junction-to-Ambient | — | — | 62 | |

** When mounted on 1" square PCB (FR-4 or G-10 Material).

For recommended footprint and soldering techniques refer to application note #AN-994.

Electrical Characteristics @ T_J = 25°C (unless otherwise specified)

| | Parameter | Min. | Typ. | Max. | Units | Test Conditions |
|--|--------------------------------------|------|-------|------|-------|---|
| V _{(BR)DSS} | Drain-to-Source Breakdown Voltage | -200 | — | — | V | V _{GS} =0V, I _D =-250μA |
| ΔV _{(BR)DSS} /ΔT _J | Breakdown Voltage Temp. Coefficient | — | -0.20 | — | V/°C | Reference to 25°C, I _D =-1mA |
| R _{DS(on)} | Static Drain-to-Source On-Resistance | — | — | 0.50 | Ω | V _{GS} =-10V, I _D =-6.6A ④ |
| V _{GS(th)} | Gate Threshold Voltage | -2.0 | — | -4.0 | V | V _{DS} =V _{GS} , I _D =-250μA |
| g _{fs} | Forward Transconductance | 4.1 | — | — | S | V _{DS} =-50V, I _D =-6.6A ④ |
| I _{DSS} | Drain-to-Source Leakage Current | — | — | -100 | μA | V _{DS} =-200V, V _{GS} =0V |
| | | — | — | -500 | | V _{DS} =-160V, V _{GS} =0V, T _J =125°C |
| I _{GSS} | Gate-to-Source Forward Leakage | — | — | -100 | nA | V _{GS} =-20V |
| | Gate-to-Source Reverse Leakage | — | — | 100 | | V _{GS} =20V |
| Q _g | Total Gate Charge | — | — | 44 | nC | I _D =-11A |
| Q _{GS} | Gate-to-Source Charge | — | — | 7.1 | | V _{DS} =-160V |
| Q _{gd} | Gate-to-Drain ("Miller") Charge | — | — | 27 | | V _{GS} =-10V See Fig. 6 and 13 ④ |
| t _{d(on)} | Turn-On Delay Time | — | 14 | — | ns | V _{DD} =-100V |
| t _r | Rise Time | — | 43 | — | | I _D =-11A |
| t _{d(off)} | Turn-Off Delay Time | — | 39 | — | | R _G =9.1Ω |
| t _f | Fall Time | — | 38 | — | | R _D =8.6Ω See Figure 10 ④ |
| L _D | Internal Drain Inductance | — | 4.5 | — | nH | Between lead, 6 mm (0.25in.) from package and center of die contact |
| L _S | Internal Source Inductance | — | 7.5 | — | | |
| C _{iss} | Input Capacitance | — | 1200 | — | pF | V _{GS} =0V |
| C _{oss} | Output Capacitance | — | 370 | — | | V _{DS} =-25V |
| C _{rss} | Reverse Transfer Capacitance | — | 81 | — | | f=1.0MHz See Figure 5 |



Source-Drain Ratings and Characteristics

| | Parameter | Min. | Typ. | Max. | Units | Test Conditions |
|-----------------|--|--|------|------|-------|---|
| I _S | Continuous Source Current (Body Diode) | — | — | -11 | A | MOSFET symbol showing the integral reverse p-n junction diode. |
| I _{SM} | Pulsed Source Current (Body Diode) ① | — | — | -44 | | |
| V _{SD} | Diode Forward Voltage | — | — | -5.0 | V | T _J =25°C, I _S =-11A, V _{GS} =0V ④ |
| t _{rr} | Reverse Recovery Time | — | 250 | 300 | ns | T _J =25°C, I _F =-11A |
| Q _{rr} | Reverse Recovery Charge | — | 2.9 | 3.6 | μC | di/dt=100A/μs ④ |
| t _{on} | Forward Turn-On Time | Intrinsic turn-on time is negligible (turn-on is dominated by L _S +L _D) | | | | |

Notes:

① Repetitive rating; pulse width limited by max. junction temperature (See Figure 11)

② V_{DD}=-50V, starting T_J=25°C, L=8.7mH
R_G=25Ω, I_{AS}=-11A (See Figure 12)

③ I_{SD}≤-11A, di/dt≤150A/μs, V_{DD}≤V_{(BR)DSS},
T_J≤150°C

④ Pulse width ≤ 300 μs; duty cycle ≤2%.

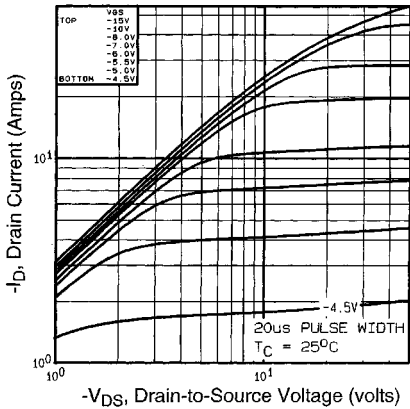

Fig 1. Typical Output Characteristics,
 $T_C=25^\circ\text{C}$

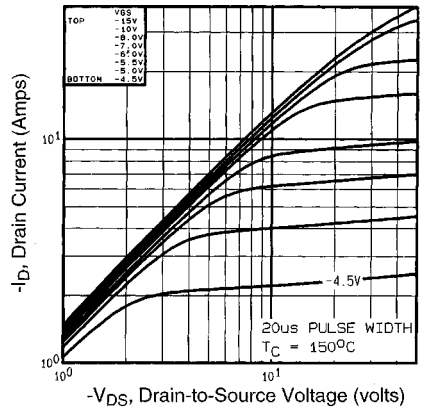

Fig 2. Typical Output Characteristics,
 $T_C=150^\circ\text{C}$

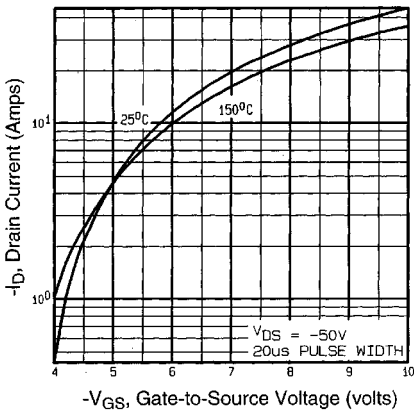

Fig 3. Typical Transfer Characteristics

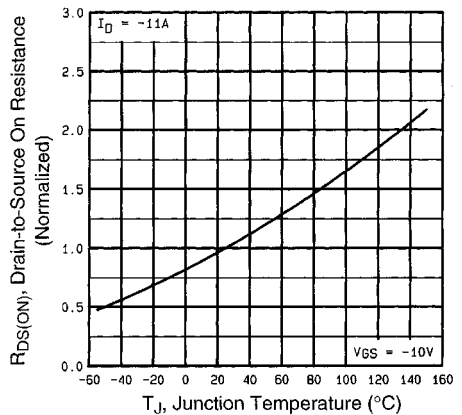

Fig 4. Normalized On-Resistance
Vs. Temperature

DATA SHEETS

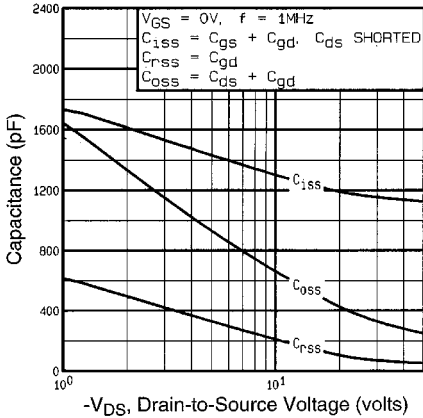

Fig 5. Typical Capacitance Vs. Drain-to-Source Voltage

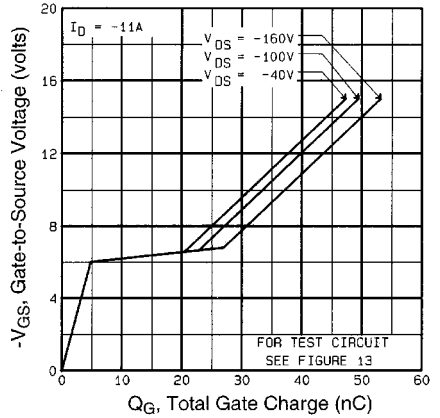

Fig 6. Typical Gate Charge Vs. Gate-to-Source Voltage

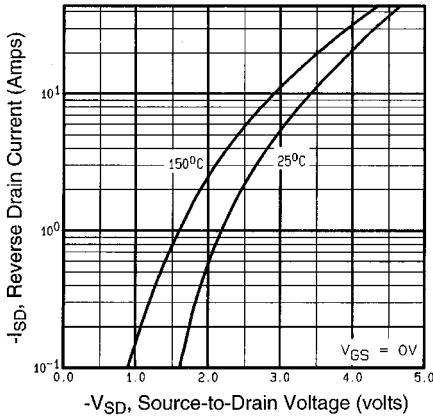

Fig 7. Typical Source-Drain Diode Forward Voltage

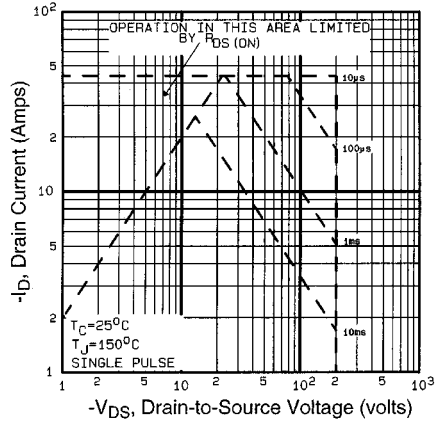

Fig 8. Maximum Safe Operating Area

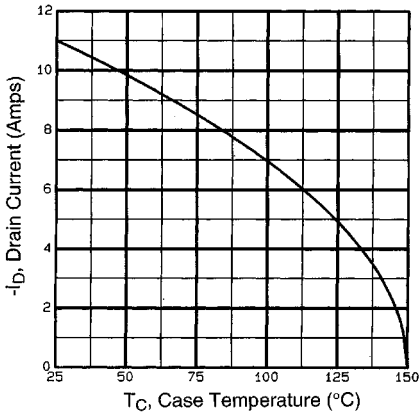

Fig 9. Maximum Drain Current Vs. Case Temperature

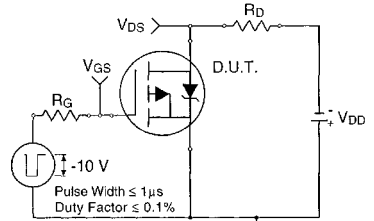

Fig 10a. Switching Time Test Circuit

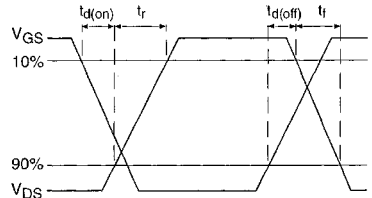

Fig 10b. Switching Time Waveforms

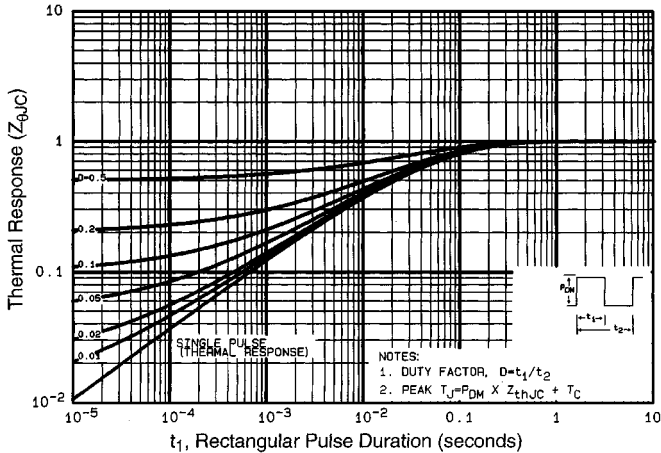

Fig 11. Maximum Effective Transient Thermal Impedance, Junction-to-Case

DATA SHEETS

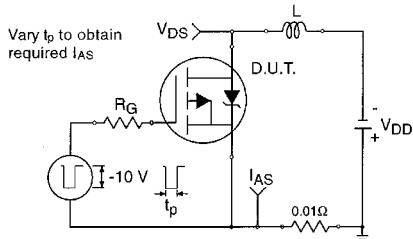

Fig 12a. Unclamped Inductive Test Circuit

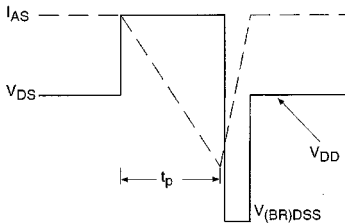

Fig 12b. Unclamped Inductive Waveforms

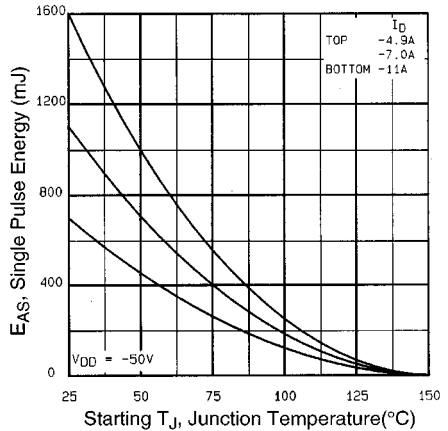

Fig 12c. Maximum Avalanche Energy Vs. Drain Current

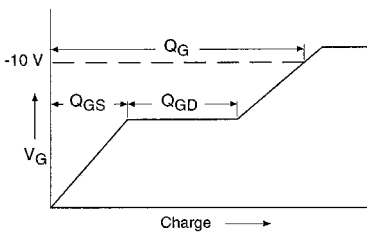

Fig 13a. Basic Gate Charge Waveform

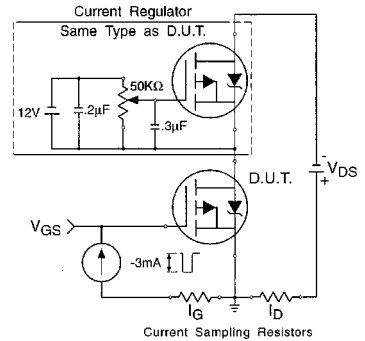

Fig 13b. Gate Charge Test Circuit

Appendix A: Figure 14, Peak Diode Recovery dv/dt Test Circuit – See page 1506

Appendix B: Package Outline Mechanical Drawing – See page 1507

Appendix C: Part Marking Information – See page 1515

Appendix D: Tape & Reel Information – See page 1519