

TOSHIBA Photocoupler GaAs Ired & Photo-Transistor

TLP321, TLP321-2, TLP321-4

Programmable Controllers
DC-Output Module
Telecommunication

The TOSHIBA TLP321, -2 and -4 consist of a photo-transistor optically coupled to a gallium arsenide infrared emitting diode. The TLP321-2 offers two isolated channels in an eight lead plastic DIP package, while the TLP321-4 provides four isolated channels in a sixteen plastic DIP package.
TLP321 / -2 / -4 have high VCEO voltage (VCEO = 80V).

- Collector-emitter voltage: 80V (min.)
- Current transfer ratio: 50% (min.)
Rank GB: 100% (min.)
- Isolation voltage: 5000Vrms (min.)
- UL recognized: UL1577, file no. E67349

Pin Configurations (top view)

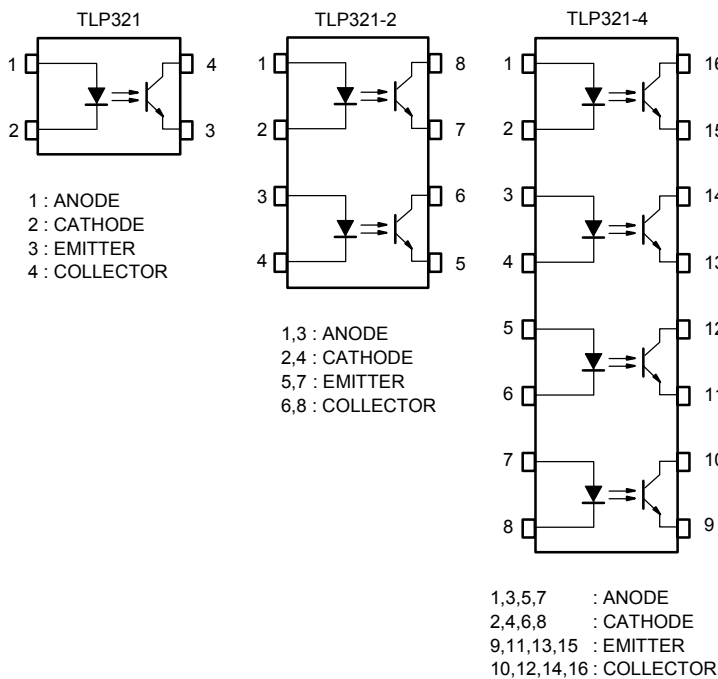

Unit in mm

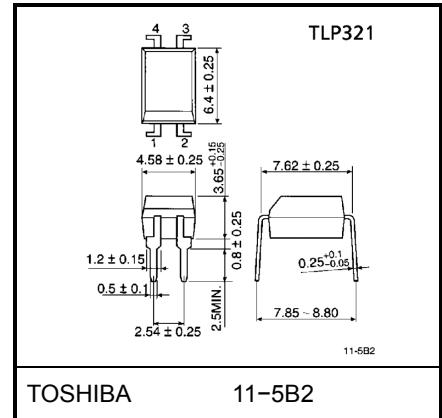

Weight: 0.26g

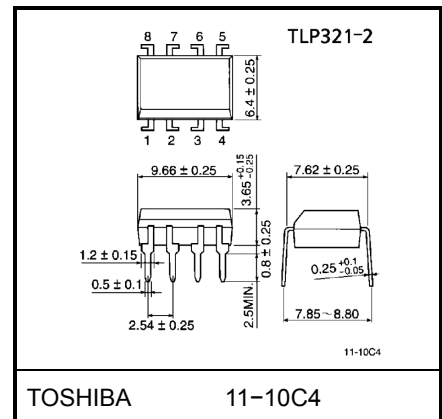

Weight: 0.54g

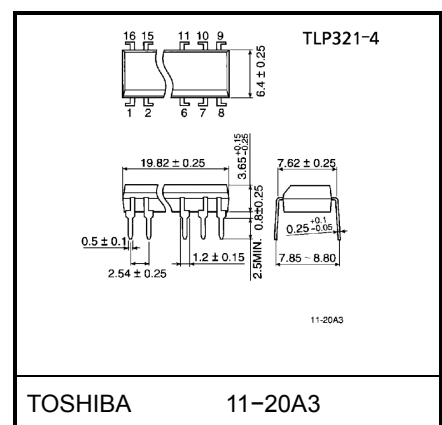

Weight: 1.1g

Current Transfer Ratio

Type	Classification *1	Current Transfer Ratio (%) (I_C / I_F)		Marking Of Classification
		$I_F = 5\text{mA}, V_{CE} = 5\text{V}, T_a = 25^\circ\text{C}$		
		Min.	Max.	
TLP321	(None)	50	600	BLANK, Y, Y [■] , G, G [■] , B, B [■] , GB
	Rank Y	50	150	Y, Y [■]
	Rank GR	100	300	G, G [■]
	Rank BL	200	600	B, B [■]
	Rank GB	100	600	G, G [■] , B, B [■] , GB
TLP321-2 TLP321-4	(None)	50	600	BLANK, GR, BL, GB
	Rank GB	100	600	GR, BL, GB

*1: Ex. Rank GB: TLP321 (GB)

(Note) Application type name for certification test, please use standard product type name, i. e.
 TLP321 (GB): TLP321
 TLP321-2 (GB): TLP321-2

Maximum Ratings (Ta = 25°C)

Characteristic	Symbol	Rating		Unit	
		TLP321-1	TLP321-2 TLP321-4		
LED	Forward current	I_F	60	50	mA
	Forward current derating	$\Delta I_F / ^\circ\text{C}$	-0.7 (Ta \geq 39°C)	-0.5 (Ta \geq 25°C)	mA / °C
	Pulse forward current	I_{FP}	1 (100µs pulse, 100pps)		A
	Reverse voltage	V_R	5		V
	Junction temperature	T_j	125		°C
Detector	Collector-emitter voltage	V_{CEO}	80		V
	Emitter-collector voltage	V_{ECO}	7		V
	Collector current	I_C	50		mA
	Collector power dissipation (1 Circuit)	P_C	150	100	mW
	Collector power dissipation derating (1 Circuit, Ta \geq 25°C)	$\Delta P_C / ^\circ\text{C}$	-1.5	-1.0	mW / °C
	Junction temperature	T_j	125		°C
Storage temperature range	T_{stg}	-55~125		°C	
Operating temperature range	T_{opr}	-55~100		°C	
Lead soldering temperature	T_{sol}	260 (10s)		°C	
Total package power dissipation	R_T	250	150	mW	
Total package power dissipation derating (Ta \geq 25°C)	$\Delta P_T / ^\circ\text{C}$	-2.5	-1.5	mW / °C	
Isolation voltage (Note 1)	BV_S	5000 (AC, 1min., RH \leq 60%)		Vrms	

(Note 1) Device considered a two terminal device: LED side pins shorted together and detector side pins shorted together.

Recommended Operating Conditions

Characteristic	Symbol	Min.	Typ.	Max.	Unit
Supply voltage	V_{CC}	—	12	48	V
Forward current	I_F	—	16	20	mA
Collector current	I_C	—	1	10	mA
Operating temperature	T_{opr}	-25	—	85	°C

Individual Electrical Characteristics (Ta = 25°C)

Characteristic		Symbol	Condition	Min.	Typ.	Max.	Unit
LED	Forward voltage	V_F	$I_F = 10 \text{ mA}$	1.0	1.15	1.3	V
	Reverse current	I_R	$V_R = 5 \text{ V}$	—	—	10	μA
	Capacitance	C_T	$V = 0, f = 1 \text{ MHz}$	—	30	—	pF
Detector	Collector-emitter breakdown voltage	$V_{(BR)CEO}$	$I_C = 0.5 \text{ mA}$	80	—	—	V
	Emitter-collector breakdown voltage	$V_{(BR)ECO}$	$I_E = 0.1 \text{ mA}$	7	—	—	V
	Collector dark current	I_{CEO}	$V_{CE} = 48 \text{ V}$	—	10	100	nA
			$V_{CE} = 48 \text{ V}, T_a = 85^\circ \text{C}$	—	2	50	μA
Capacitance (collector to emitter)	C_{CE}	$V = 0, f = 1 \text{ MHz}$	—	10	—	pF	

Coupled Electrical Characteristics (Ta = 25°C)

Characteristic	Symbol	Condition	Min.	Typ.	Max.	Unit
Current transfer ratio	I_C / I_F	$I_F = 5 \text{ mA}, V_{CE} = 5 \text{ V}$ Rank GB	50	—	600	%
			100	—	600	
Saturated CTR	$I_C / I_F (\text{sat})$	$I_F = 1 \text{ mA}, V_{CE} = 0.4 \text{ V}$ Rank GB	—	60	—	%
			30	—	—	
Collector-emitter saturation voltage	$V_{CE} (\text{sat})$	$I_C = 2.4 \text{ mA}, I_F = 8 \text{ mA}$	—	—	0.4	V
		$I_C = 0.2 \text{ mA}, I_F = 1 \text{ mA}$ Rank GB	—	0.2	—	
			—	—	0.4	

Isolation Characteristics (Ta = 25°C)

Characteristic	Symbol	Test Condition	Min.	Typ.	Max.	Unit
Capacitance (input to output)	C_S	$V_S = 0, f = 1\text{MHz}$	—	0.8	—	pF
Isolation resistance	R_S	$V_S = 500\text{V}, \text{R.H.} \leq 60\%$	5×10^{10}	10^{14}	—	Ω
Isolation voltage	BV_S	AC, 1 minute	5000	—	—	Vrms
		AC, 1 second, in oil	—	10000	—	Vrms
		DC, 1 minute, in oil	—	10000	—	Vdc

Switching Characteristics (Ta = 25°C)

Characteristic	Symbol	Test Condition	Min.	Typ.	Max.	Unit
Rise time	t_r	$V_{CC} = 10\text{V}$ $I_C = 2\text{mA}$ $R_L = 100\Omega$	—	2	—	μs
Fall time	t_f		—	3	—	
Turn-on time	t_{on}		—	3	—	
Turn-off time	t_{off}		—	3	—	
Turn-on time	t_{ON}	$R_L = 1.9\text{k}\Omega$ (Fig.1) $V_{CC} = 5\text{V}, I_F = 16\text{mA}$	—	2	—	μs
Storage time	t_s		—	15	—	
Turn-off time	t_{OFF}		—	25	—	

Fig. 1 Switching time test circuit

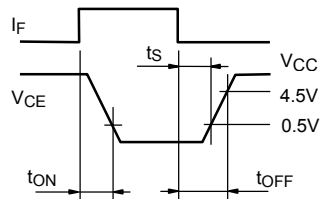
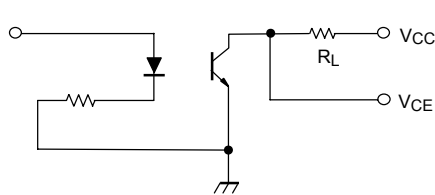

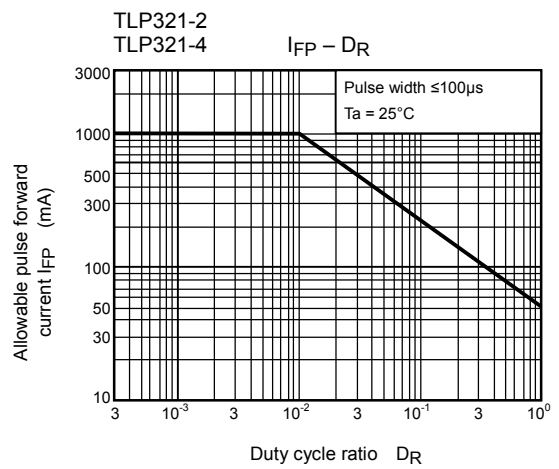
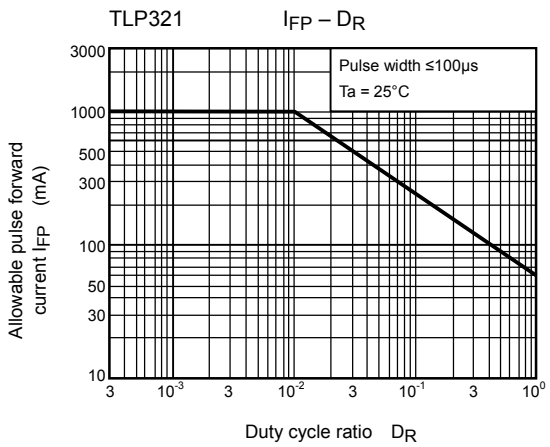
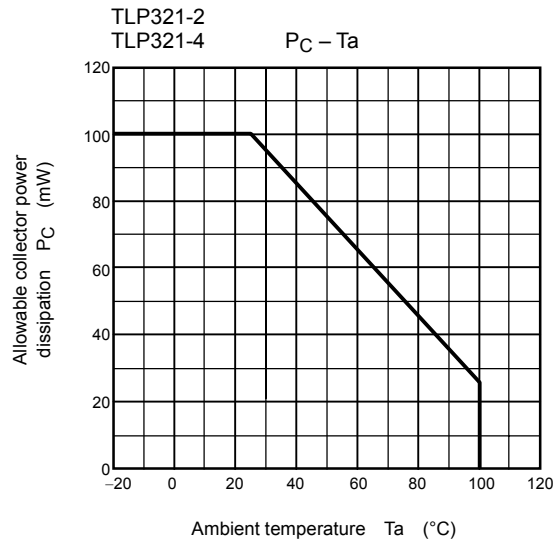
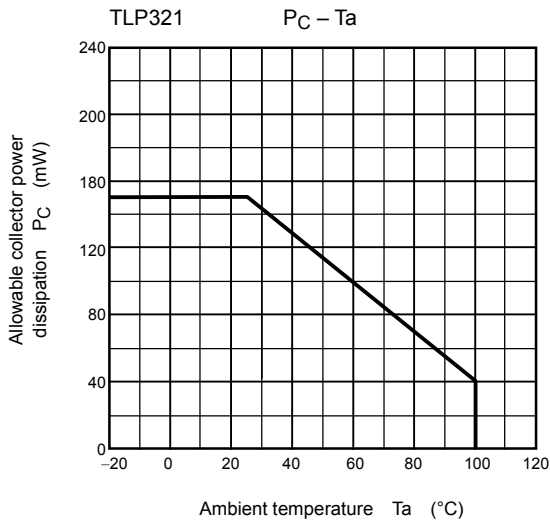
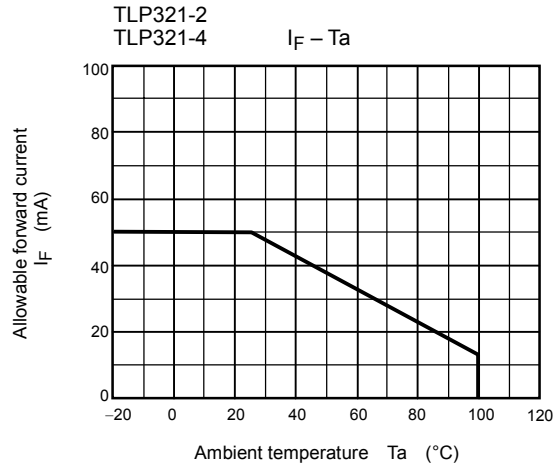
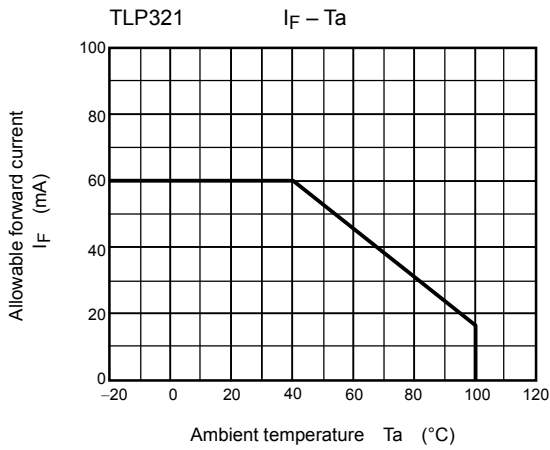

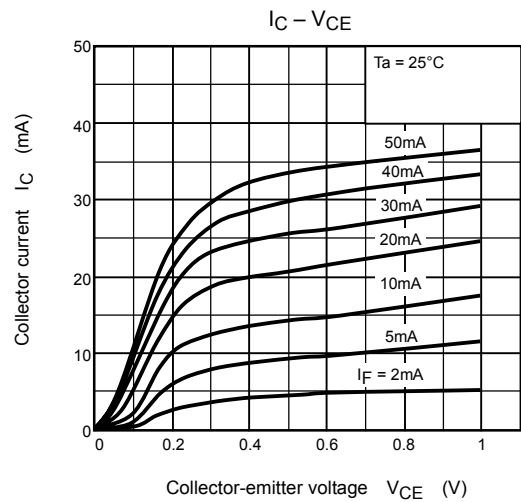
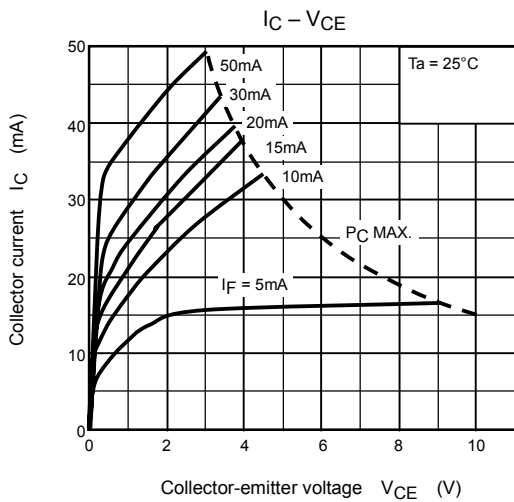
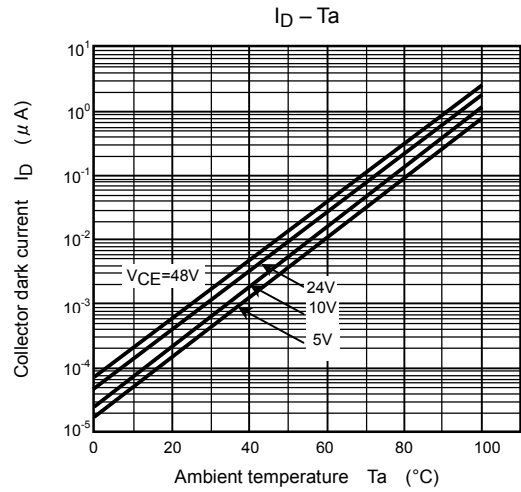
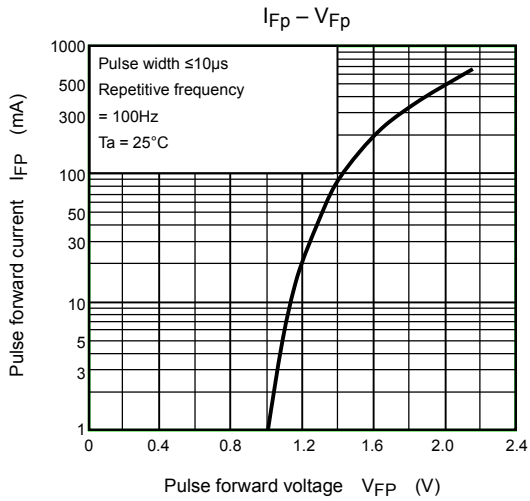
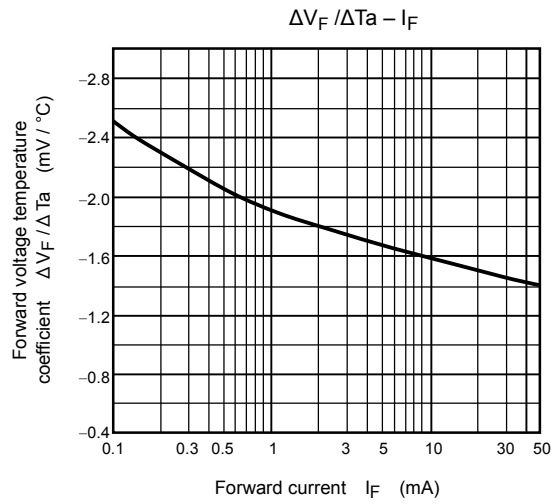
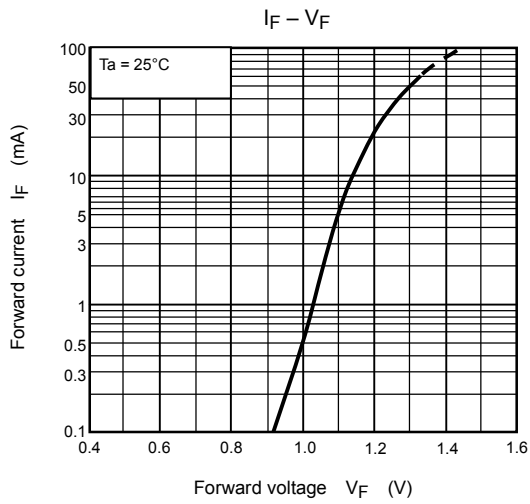

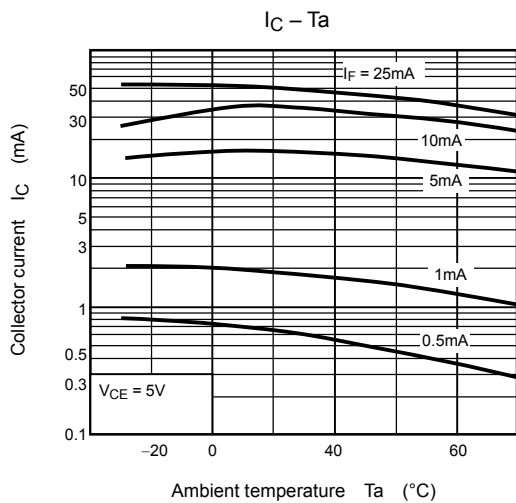
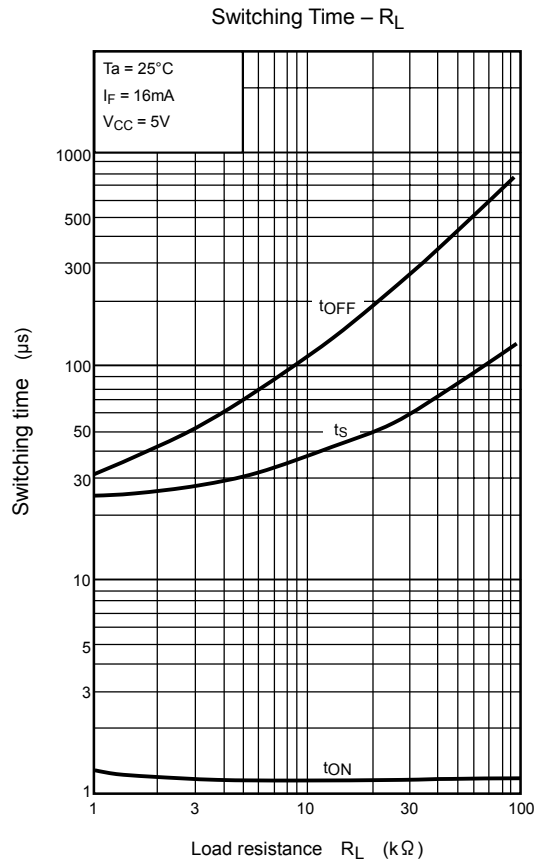
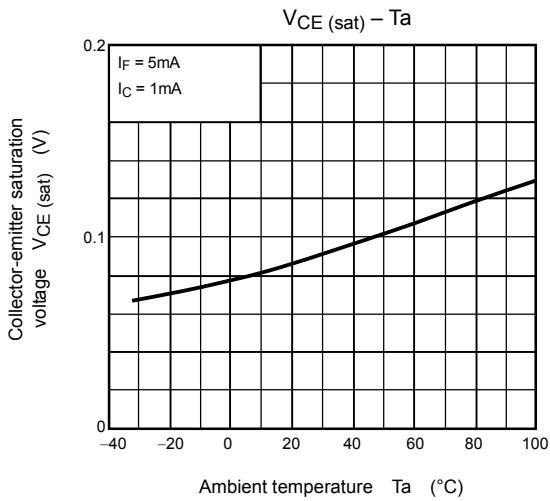
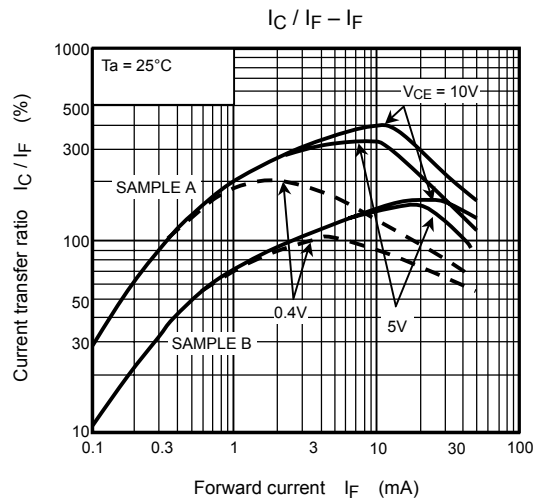
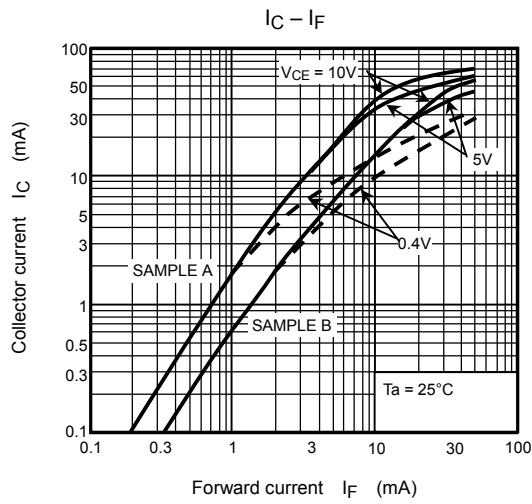

RESTRICTIONS ON PRODUCT USE

000707EBC

- TOSHIBA is continually working to improve the quality and reliability of its products. Nevertheless, semiconductor devices in general can malfunction or fail due to their inherent electrical sensitivity and vulnerability to physical stress. It is the responsibility of the buyer, when utilizing TOSHIBA products, to comply with the standards of safety in making a safe design for the entire system, and to avoid situations in which a malfunction or failure of such TOSHIBA products could cause loss of human life, bodily injury or damage to property.
In developing your designs, please ensure that TOSHIBA products are used within specified operating ranges as set forth in the most recent TOSHIBA products specifications. Also, please keep in mind the precautions and conditions set forth in the "Handling Guide for Semiconductor Devices," or "TOSHIBA Semiconductor Reliability Handbook" etc..
- The TOSHIBA products listed in this document are intended for usage in general electronics applications (computer, personal equipment, office equipment, measuring equipment, industrial robotics, domestic appliances, etc.). These TOSHIBA products are neither intended nor warranted for usage in equipment that requires extraordinarily high quality and/or reliability or a malfunction or failure of which may cause loss of human life or bodily injury ("Unintended Usage"). Unintended Usage include atomic energy control instruments, airplane or spaceship instruments, transportation instruments, traffic signal instruments, combustion control instruments, medical instruments, all types of safety devices, etc.. Unintended Usage of TOSHIBA products listed in this document shall be made at the customer's own risk.
- Gallium arsenide (GaAs) is a substance used in the products described in this document. GaAs dust and fumes are toxic. Do not break, cut or pulverize the product, or use chemicals to dissolve them. When disposing of the products, follow the appropriate regulations. Do not dispose of the products with other industrial waste or with domestic garbage.
- The products described in this document are subject to the foreign exchange and foreign trade laws.
- The information contained herein is presented only as a guide for the applications of our products. No responsibility is assumed by TOSHIBA CORPORATION for any infringements of intellectual property or other rights of the third parties which may result from its use. No license is granted by implication or otherwise under any intellectual property or other rights of TOSHIBA CORPORATION or others.
- The information contained herein is subject to change without notice.