

TOSHIBA Photocoupler GaAs IRed & Photo-Triac

TLP525G, TLP525G-2, TLP525G-4

- Triac Drive
- Programmable Controllers
- AC-Output Module
- Solid State Relay

The TOSHIBA TLP525G, -2 and -4 consist of a photo-triac optically coupled to a gallium arsenide infrared emitting diode.

The TLP525G-2 offers two isolated channels in an eight lead plastic DIP package, while the TLP525G-4 provides four isolated channels in a sixteen lead plastic DIP package.

- Peak off-stage voltage: 400V (min.)
- Trigger LED current: 10mA (max.)
- Peak on-stage current: 2Apk (max.)
- Isolation voltage: 2500V_{rms} (min.)
- UL recognized: File no.E67349

Pin Configurations (top view)

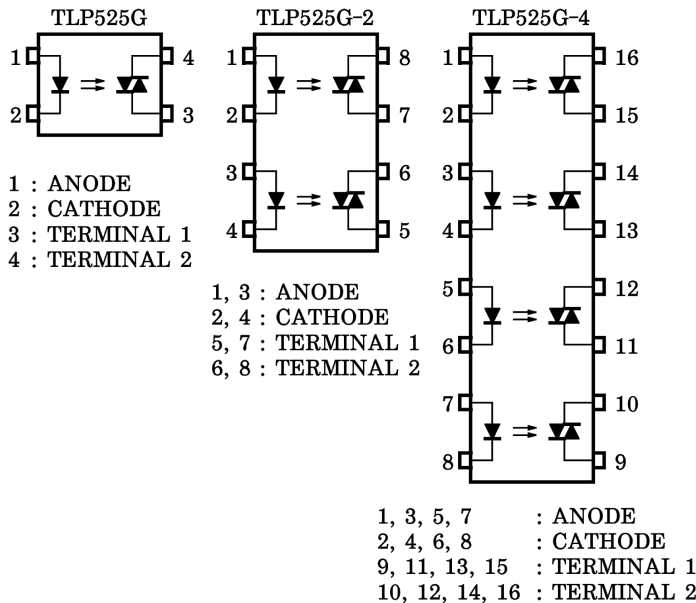

Unit in mm

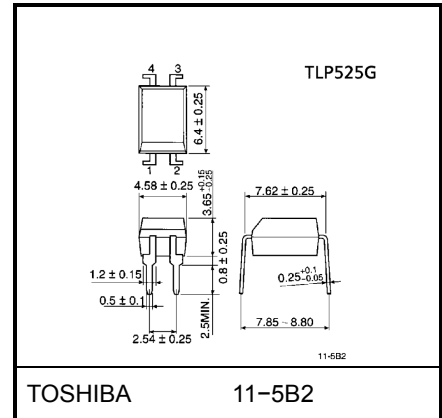

Weight: 0.26g

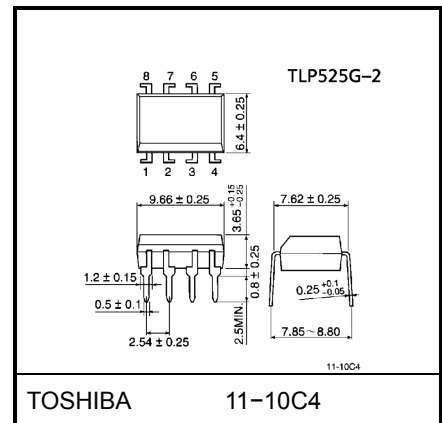

Weight: 0.54g

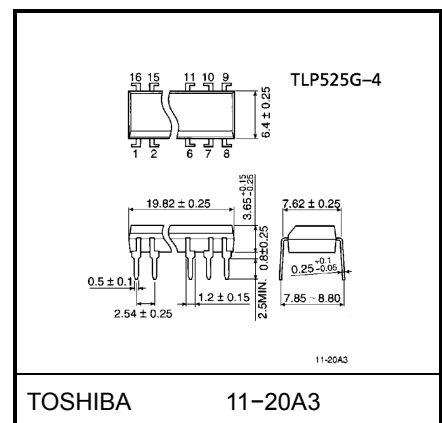

Weight: 1.1g

Maximum Ratings (Ta = 25°C)

Characteristic		Symbol	Rating		Unit	
			TLP525G	TLP525G-2 TLP525G-4		
LED	Forward current	I_F	50	50	mA	
	Forward current derating	$I_F / ^\circ\text{C}$	-0.7 (Ta ≥ 53°C)	-0.5 (Ta ≥ 25°C)	mA / °C	
	Pulse forward current	I_{FP}	1 (100µs pulse, 100pps)		A	
	Reverse voltage	V_R	5		V	
	Junction temperature	T_j	125		°C	
Detector	Off-state output terminal voltage	V_{DRM}	400		V	
	On-state RMS current	I_T (RMS)	Ta = 25°C	100	80	mA
			Ta = 70°C	50	40	
	On-state current derating (Ta ≥ 25°C)	$I_T / ^\circ\text{C}$	-1.1	-0.9	mA / °C	
	Peak on state current	I_{TP}	2 (100µs pulse, 120pps)		A	
	Peak nonrepetitive surge current (PW = 10ms, DC = 10%)	I_{TSM}	1.2		A	
	Junction temperature	T_j	115		°C	
Storage temperature range	T_{stg}	-55~125		°C		
Operating temperature range	T_{opr}	-40~100		°C		
Lead soldering temperature	T_{sol}	260 (10s)		°C		
Isolation voltage (Note)	BV_S	2500 (AC, 1min., R.H. ≤ 60%)		V_{rms}		

(Note) Device considered a two terminal device: LED side pins shorted together and detector side pins shorted together.

Recommended Operating Conditions

Characteristic	Symbol	Min.	Typ.	Max.	Unit
Supply voltage	V_{AC}	—	—	120	Vac
Forward current	I_F	15	20	25	mA
Peak on-state current	I_{TP}	—	—	1	A
Operating temperature	T_{opr}	-25	—	85	°C

Individual Electrical Characteristics (Ta = 25°C)

Characteristic		Symbol	Test Condition	Min.	Typ.	Max.	Unit
LED	Forward voltage	V_F	$I_F = 10\text{mA}$	1.0	1.15	1.3	V
	Reverse current	I_R	$V_R = 5\text{V}$	—	—	10	μA
	Capacitance	C_T	$V = 0, f = 1\text{MHz}$	—	30	—	pF
Detector	Peak off-state current	I_{DRM}	$V_{DRM} = 400\text{V}$	—	10	100	nA
	Peak on-state voltage	V_{TM}	$I_{TM} = 100\text{mA}$	—	1.7	3.0	V
	Holding current	I_H	—	—	0.2	—	mA
	Critical rate of rise of off-state voltage	dv/dt	$V_{in} = 120\text{V}_{rms}, T_a = 85^\circ\text{C}$ (Figure 1)	200	500	—	V/ μs
	Critical rate of rise of commutating voltage	$dv/dt(c)$	$V_{in} = 30\text{V}_{rms}, I_T = 15\text{mA}$ (Figure 1)	—	0.2	—	V/ μs

Coupled Electrical Characteristics (Ta = 25°C)

Characteristic	Symbol	Test Condition	Min.	Typ.	Max.	Unit
Trigger LED current	I_{FT}	$V_T = 3\text{V}$	—	5	10	mA
Capacitance input to output	C_S	$V_S = 0, f = 1\text{MHz}$	—	0.8	—	pF
Isolation resistance	R_S	$V_S = 500\text{V}, \text{R.H.} \leq 60\%$	5×10^{10}	10^{14}	—	Ω
Isolation voltage	BV_S	AC, 1 minute	2500	—	—	Vrms
		AC, 1 second, in oil	—	5000	—	
		DC, 1 minute, in oil	—	5000	—	Vdc

Fig.1 dv / dt Test Circuit

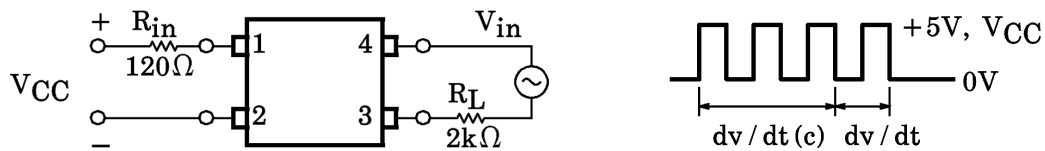

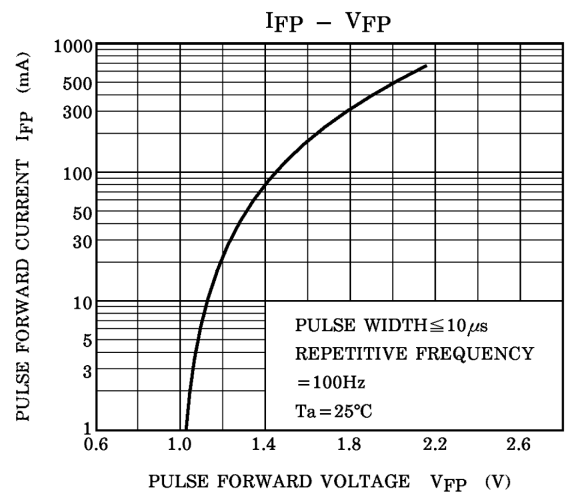
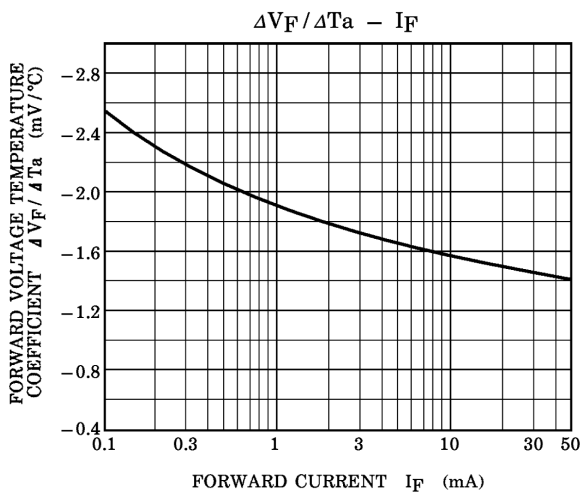
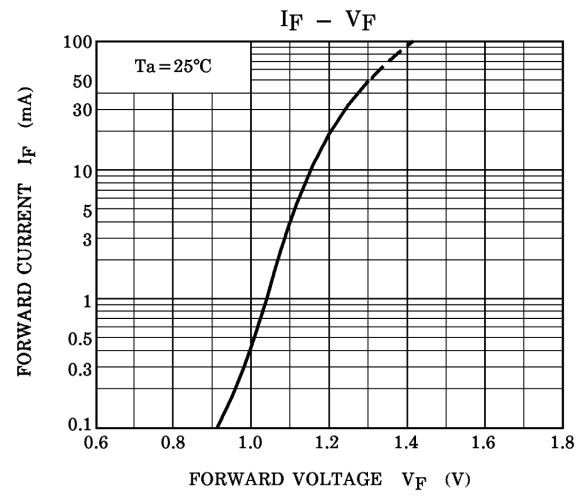
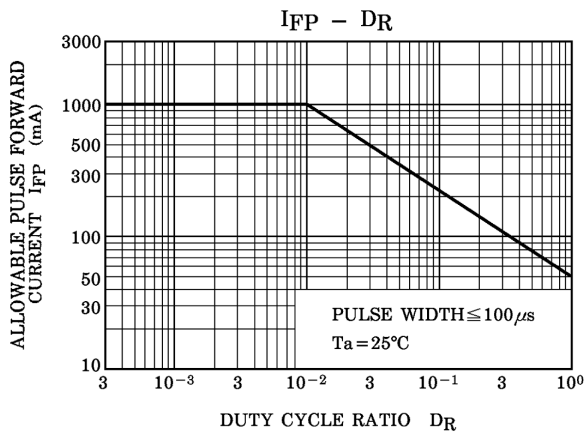
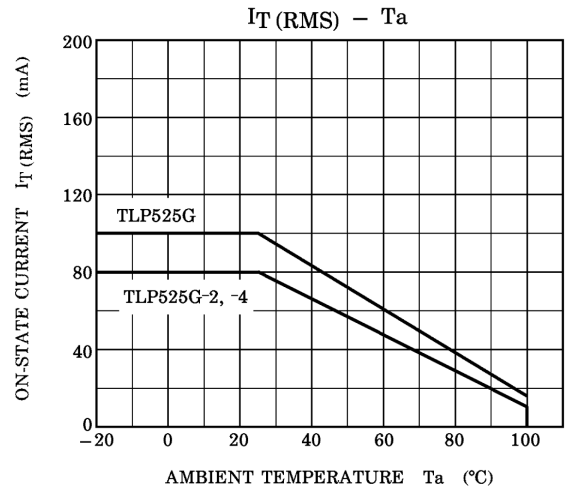
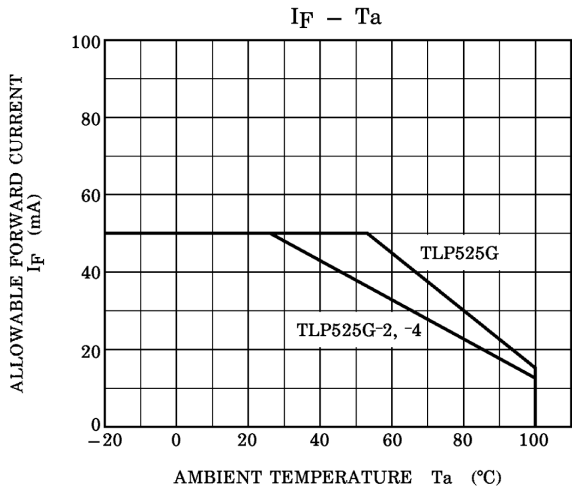

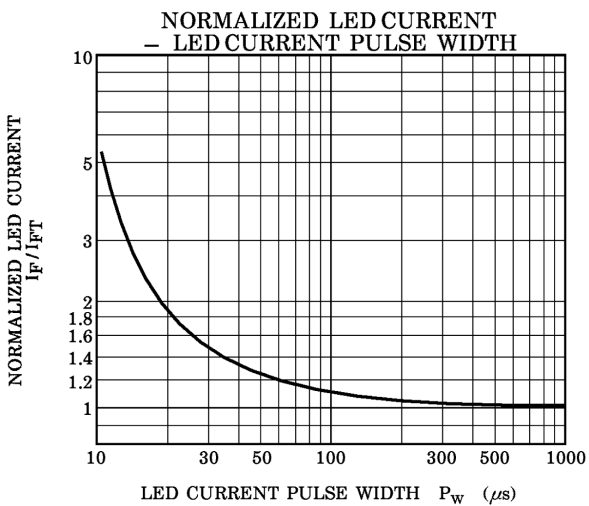
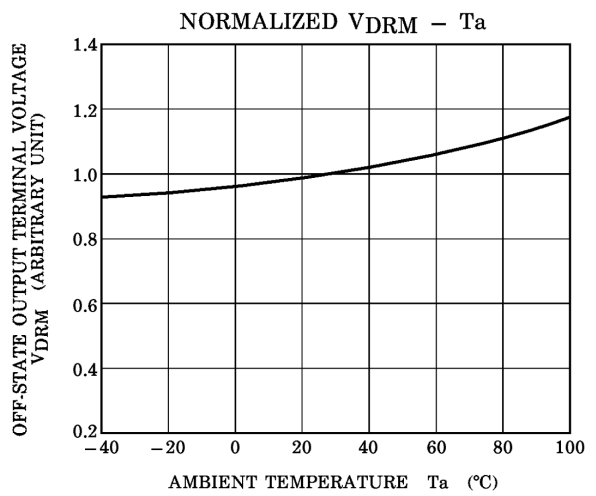
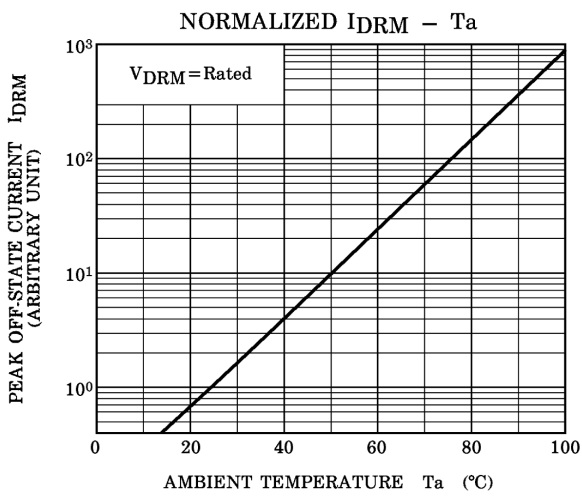
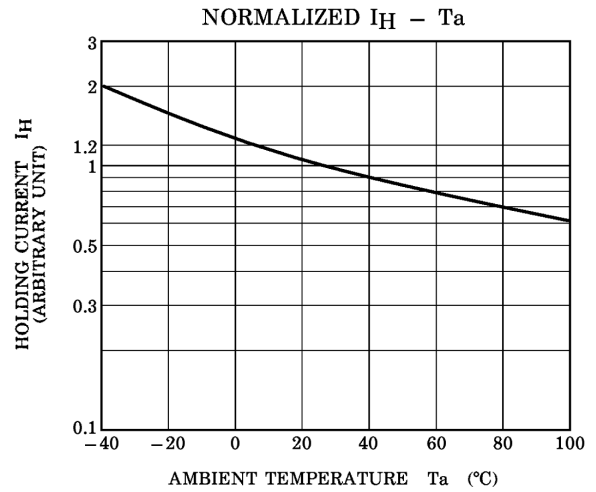
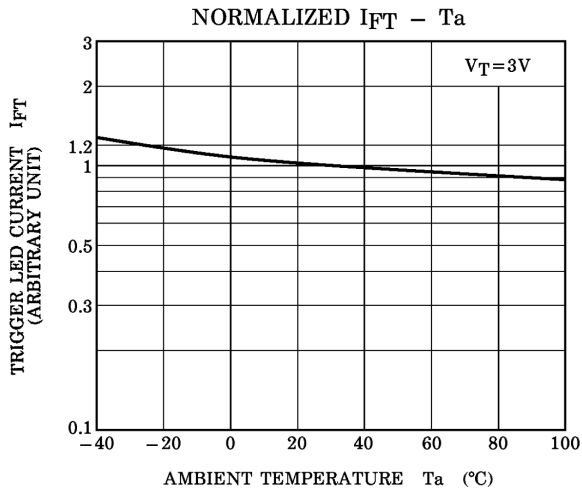

RESTRICTIONS ON PRODUCT USE

000707EAA

- TOSHIBA is continually working to improve the quality and reliability of its products. Nevertheless, semiconductor devices in general can malfunction or fail due to their inherent electrical sensitivity and vulnerability to physical stress. It is the responsibility of the buyer, when utilizing TOSHIBA products, to comply with the standards of safety in making a safe design for the entire system, and to avoid situations in which a malfunction or failure of such TOSHIBA products could cause loss of human life, bodily injury or damage to property.
In developing your designs, please ensure that TOSHIBA products are used within specified operating ranges as set forth in the most recent TOSHIBA products specifications. Also, please keep in mind the precautions and conditions set forth in the "Handling Guide for Semiconductor Devices," or "TOSHIBA Semiconductor Reliability Handbook" etc..
- The TOSHIBA products listed in this document are intended for usage in general electronics applications (computer, personal equipment, office equipment, measuring equipment, industrial robotics, domestic appliances, etc.). These TOSHIBA products are neither intended nor warranted for usage in equipment that requires extraordinarily high quality and/or reliability or a malfunction or failure of which may cause loss of human life or bodily injury ("Unintended Usage"). Unintended Usage include atomic energy control instruments, airplane or spaceship instruments, transportation instruments, traffic signal instruments, combustion control instruments, medical instruments, all types of safety devices, etc.. Unintended Usage of TOSHIBA products listed in this document shall be made at the customer's own risk.
- The information contained herein is presented only as a guide for the applications of our products. No responsibility is assumed by TOSHIBA CORPORATION for any infringements of intellectual property or other rights of the third parties which may result from its use. No license is granted by implication or otherwise under any intellectual property or other rights of TOSHIBA CORPORATION or others.
- The information contained herein is subject to change without notice.