

TOSHIBA Photocoupler GaAs Ired&Photo-Transistor

TLP733, TLP734

- Office Machine
- Household Use Equipment
- Solid State Relay
- Switching Power Supply

The TOSHIBA TLP733 and TLP734 consist of a photo-transistor optically coupled to a gallium arsenide infrared emitting diode in a six lead plastic DIP.

TLP734 is no-base internal connection for high-EMI environments.

- Collector-emitter voltage: 55 V (min.)
- Current transfer ratio: 50% (min.)
Rank GB: 100% (min.)
- UL recognized: UL1577, file no. E67349
- BSI approved: BS EN60065: 1994
Certificate no. 7364
BS EN60950: 1992
Certificate no. 7365
- SEMKO approved: SS4330784
Certificate no. 9325163, 9522142
- Isolation voltage: 4000 V_{rms} (min.)
- Option (D4) type
VDE approved: DIN VDE0884 / 06.92,
Certificate no. 74286, 91808
Maximum operating insulation voltage: 630, 890 VPK
Highest permissible over voltage: 6000, 8000 VPK

(Note) When a VDE0884 approved type is needed, please designate the "Option (D4)"

	7.62 mm pich standard type	10.16 mm pich TLPxxxF type
• Creepage distance	: 7.0 mm (min.)	8.0 mm (min.)
Clearance	: 7.0 mm (min.)	8.0 mm (min.)
Internal creepage path	: 4.0 mm (min.)	4.0 mm (min.)
Insulation thickness	: 0.5 mm (min.)	0.5 mm (min.)

Unit in mm

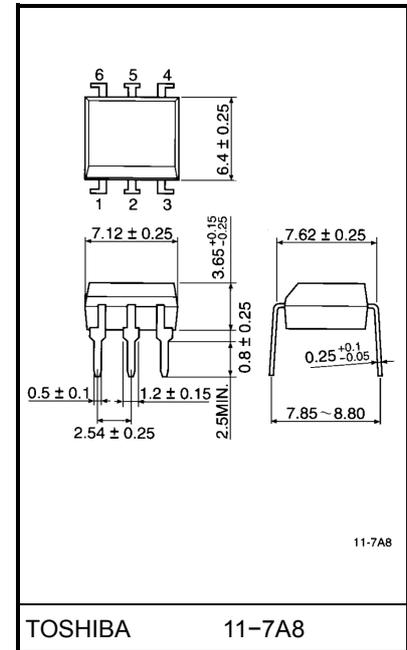

Weight: 0.42 g

Pin Configurations (top view)

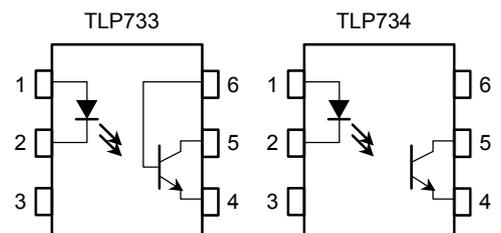

- 1: Anode
- 2: Cathode
- 3: Nc
- 4: Emitter
- 5: Collector
- 6: Base

- 1: Anode
- 2: Cathode
- 3: Nc
- 4: Emitter
- 5: Collector
- 6: Nc

Current Transfer Ratio

Type	Classification *1	Current Transfer Ratio (%) (I_C / I_F)		Marking Of Classification
		$I_F = 5\text{mA}, V_{CE} = 5\text{V}, T_a = 25^\circ\text{C}$		
		Min.	Max.	
TLP733 TLP734	(None)	50	600	Blank, Y, Y [■] , G, G [■] , B, B [■] , GB
		50	150	Y, Y [■]
	Rank GR	100	300	G, G [■]
		200	600	B, B [■]
	Rank GB	100	600	G, G [■] , B, B [■] , GB

*1: Ex. rank GB: TLP733 (GB)

Note: Application type name for certification test, please use standard product type name, i.e. TLP733 (GB): TLP733

Maximum Ratings ($T_a = 25^\circ\text{C}$)

Characteristic		Symbol	Rating	Unit
LED	Forward current	I_F	60	mA
	Forward current derating ($T_a \geq 39^\circ\text{C}$)	$\Delta I_F / ^\circ\text{C}$	-0.7	mA / $^\circ\text{C}$
	Peak forward current (100 μs pulse, 100 pps)	I_{FP}	1	A
	Reverse voltage	V_R	5	V
	Junction temperature	T_j	125	$^\circ\text{C}$
Detector	Collector-emitter voltage	V_{CEO}	55	V
	Collector-base voltage (TLP733)	V_{CBO}	80	V
	Emitter-collector voltage	V_{ECO}	7	V
	Emitter-base voltage (TLP733)	V_{EBO}	7	V
	Collector current	I_C	50	mA
	Power dissipation	P_C	150	mW
	Power dissipation derating ($T_a \geq 25^\circ\text{C}$)	$\Delta P_C / ^\circ\text{C}$	-1.5	mW / $^\circ\text{C}$
	Junction temperature	T_j	125	$^\circ\text{C}$
Storage temperature range		T_{stg}	-55~125	$^\circ\text{C}$
Operating temperature range		T_{opr}	-40~100	$^\circ\text{C}$
Lead soldering temperature (10 s)		T_{sol}	260	$^\circ\text{C}$
Total package power dissipation		P_T	250	mW
Total package power dissipation derating ($T_a \geq 25^\circ\text{C}$)		$\Delta P_T / ^\circ\text{C}$	-2.5	mW / $^\circ\text{C}$
Isolation voltage (AC, 1 min., R.H. \leq 60%)		BV_S	4000	V_{rms}

Recommended Operating Conditions

Characteristic	Symbol	Min.	Typ.	Max.	Unit
Supply voltage	V_{CC}	—	5	24	V
Forward current	I_F	—	16	25	mA
Collector current	I_C	—	1	10	mA
Operating temperature	T_{opr}	-25	—	85	°C

Individual Electrical Characteristics (Ta = 25°C)

Characteristic		Symbol	Test Condition	Min.	Typ.	Max.	Unit
LED	Forward voltage	V_F	$I_F = 10 \text{ mA}$	1.0	1.15	1.3	V
	Reverse current	I_R	$V_R = 5 \text{ V}$	—	—	10	μA
	Capacitance	C_T	$V = 0, f = 1 \text{ MHz}$	—	30	—	pF
Detector	Collector-emitter breakdown voltage	$V_{(BR)CEO}$	$I_C = 0.5 \text{ mA}$	55	—	—	V
	Emitter-collector breakdown voltage	$V_{(BR)ECO}$	$I_E = 0.1 \text{ mA}$	7	—	—	V
	Collector-base breakdown voltage (TLP733)	$V_{(BR)CBO}$	$I_C = 0.1 \text{ mA}$	80	—	—	V
	Emitter-base breakdown voltage (TLP733)	$V_{(BR)EBO}$	$I_E = 0.1 \text{ mA}$	7	—	—	V
	Collector dark current	I_{CEO}	$V_{CE} = 24 \text{ V}$ (ambient light below 1000 lx)	—	0.01 (2)	0.1 (10)	μA
			$V_{CE} = 24 \text{ V}$ $T_a = 85^\circ\text{C}$ (ambient light below 1000 lx)	—	2 (4)	50 (50)	μA
	Collector dark current (TLP733)	I_{CER}	$V_{CE} = 24 \text{ V}, T_a = 85^\circ\text{C}$ $R_{BE} = 1\text{M}\Omega$	—	0.5	10	μA
	Collector dark current (TLP733)	I_{CBO}	$V_{CB} = 10 \text{ V}$	—	0.1	—	nA
	DC forward current gain (TLP733)	h_{FE}	$V_{CE} = 5 \text{ V}, I_C = 0.5 \text{ mA}$	—	400	—	—
Capacitance collector to emitter	C_{CE}	$V = 0, f = 1 \text{ MHz}$	—	10	—	pF	

Coupled Electrical Characteristics (Ta = 25°C)

Characteristic	Symbol	Test Condition	Min.	Typ.	Max.	Unit
Current transfer ratio	I_C / I_F	$I_F = 5 \text{ mA}, V_{CE} = 5 \text{ V}$ Rank GB	50	—	600	%
			100	—	600	
Saturated CTR	$I_C / I_F (\text{sat})$	$I_F = 1 \text{ mA}, V_{CE} = 0.4 \text{ V}$ Rank GB	—	60	—	%
			30	—	—	
Base photo-current	I_{PB}	$I_F = 5 \text{ mA}, V_{CB} = 5 \text{ V}$	—	10	—	%
Collector-emitter saturation voltage	$V_{CE} (\text{sat})$	$I_C = 2.4 \text{ mA}, I_F = 8 \text{ mA}$	—	—	0.4	V
		$I_C = 0.2 \text{ mA}, I_F = 1 \text{ mA}$ Rank GB	—	0.2	—	
			—	—	0.4	

Isolation Characteristics (Ta = 25°C)

Characteristic	Symbol	Test Condition	Min.	Typ.	Max.	Unit
Capacitance (input to output)	C_S	$V_S = 0, f = 1 \text{ MHz}$	—	0.8	—	pF
Isolation resistance	R_S	$V_S = 500 \text{ V}, R.H. \leq 60\%$	1×10^{12}	10^{14}	—	Ω
Isolation voltage	BV_S	AC, 1 minute	4000	—	—	Vrms
		AC, 1 second, in oil	—	10000	—	
		DC, 1 minute, in oil	—	10000	—	Vdc

Switching Characteristics (Ta = 25°C)

Characteristic	Symbol	Test Condition	Min.	Typ.	Max.	Unit
Rise time	t_r	$V_{CC} = 10 \text{ V}, I_C = 2 \text{ mA}$ $R_L = 100 \Omega$	—	2	—	μs
Fall time	t_f		—	3	—	
Turn-on time	t_{ON}		—	3	10	
Turn-off time	t_{OFF}		—	3	10	
Turn-on time	t_{ON}	$R_L = 1.9 \text{ k}\Omega$ $R_{BE} = \text{open}$ $V_{CC} = 5 \text{ V}, I_F = 16 \text{ mA}$ (Fig.1)	—	3	—	μs
Storage time	t_s		—	40	—	
Turn-off time	t_{OFF}		—	90	—	
Turn-on time	t_{ON}	$R_L = 1.9 \text{ k}\Omega$ $R_{BE} = 220 \text{ k}\Omega$ (TLP733) $V_{CC} = 5 \text{ V}, I_F = 16 \text{ mA}$ (Fig.1)	—	3	—	μs
Storage time	t_s		—	30	—	
Turn-off time	t_{OFF}		—	60	—	

Fig. 1 Switching time test circuit

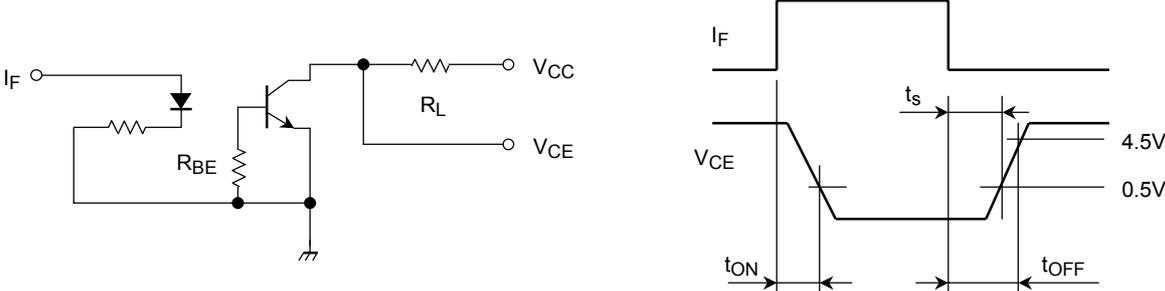

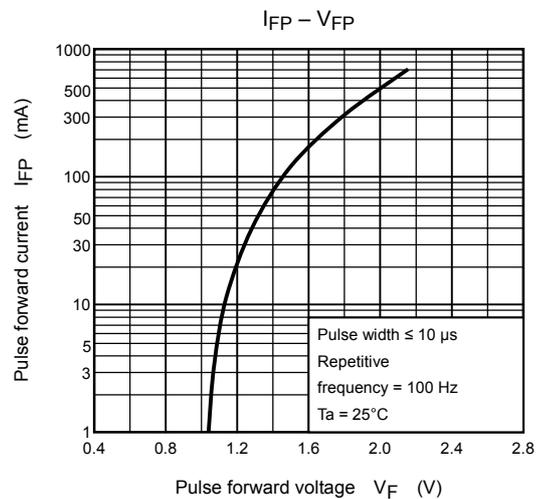
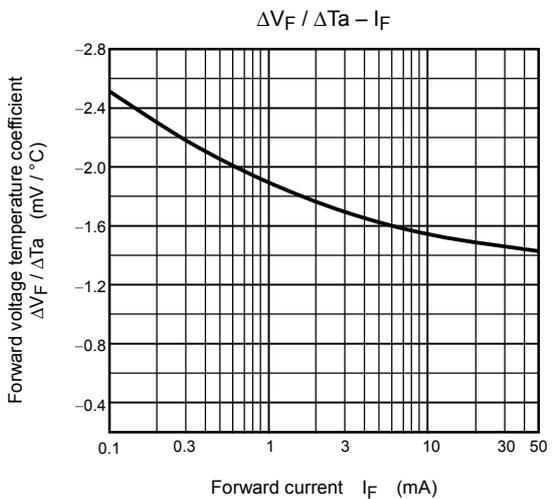
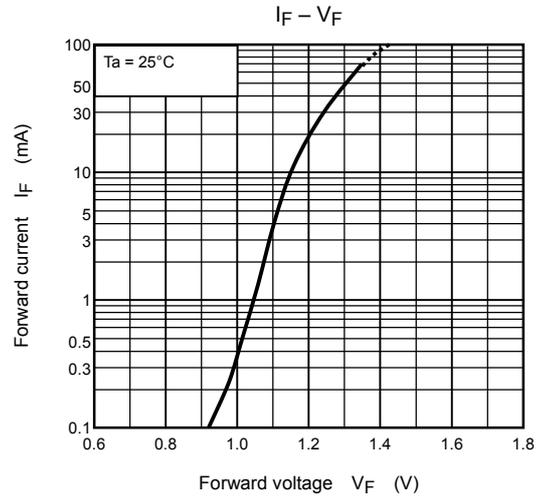
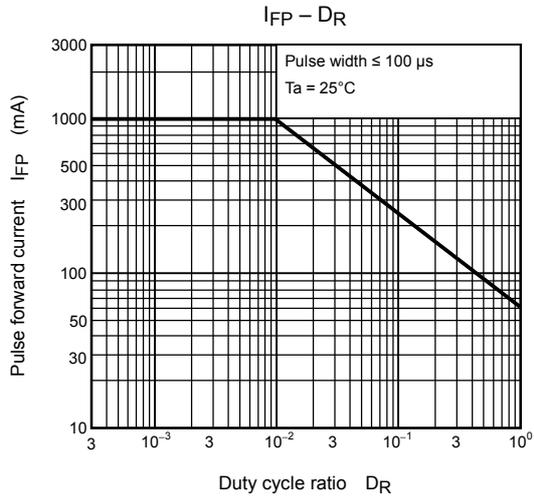
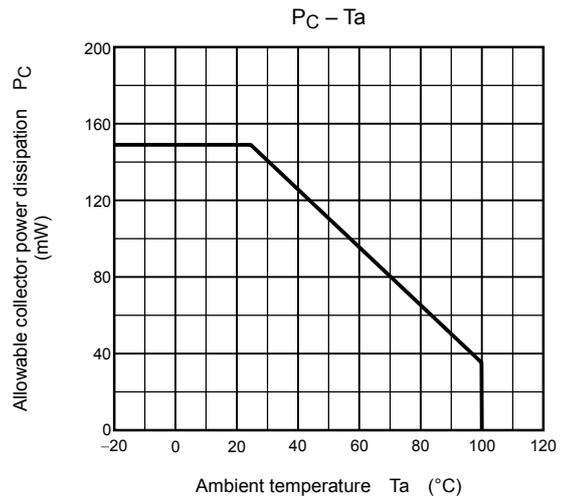
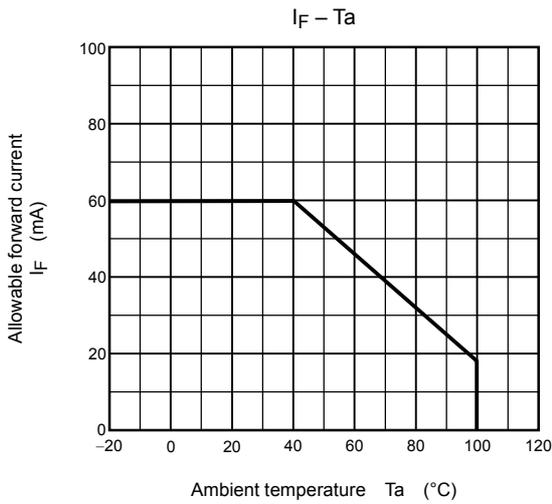

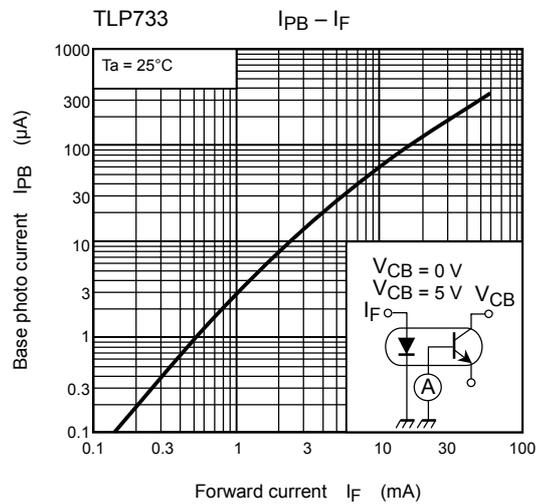
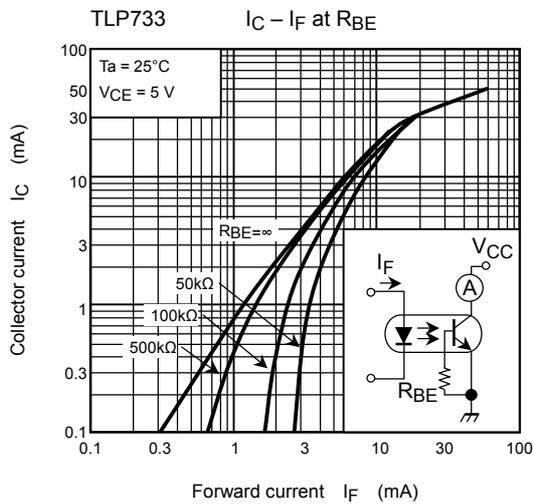
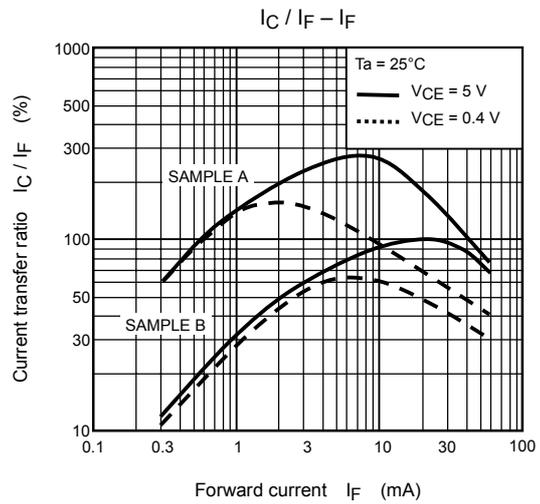
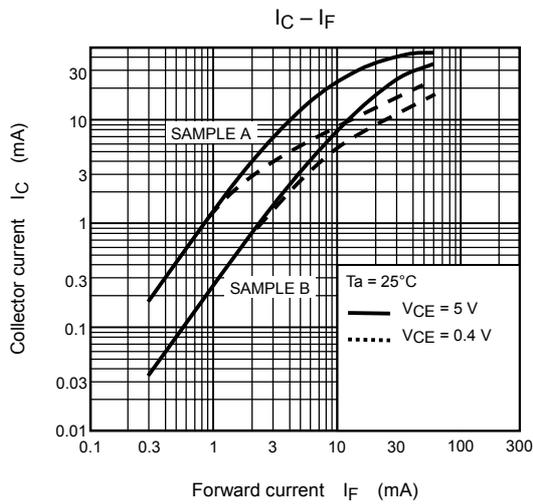
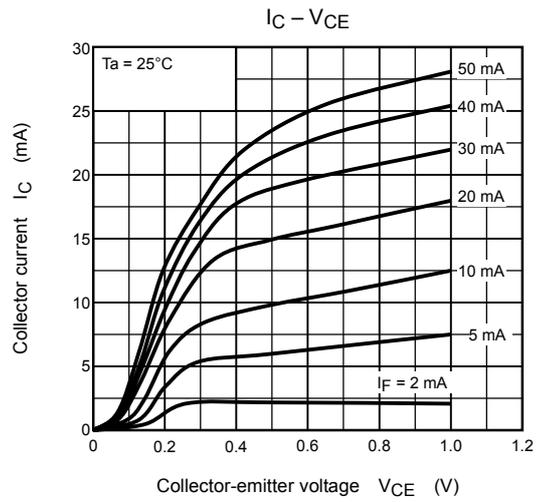
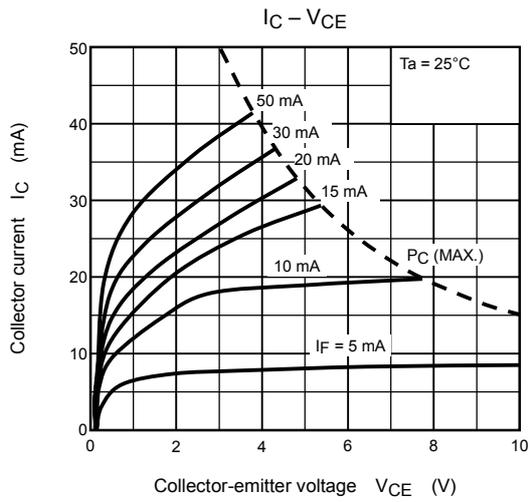

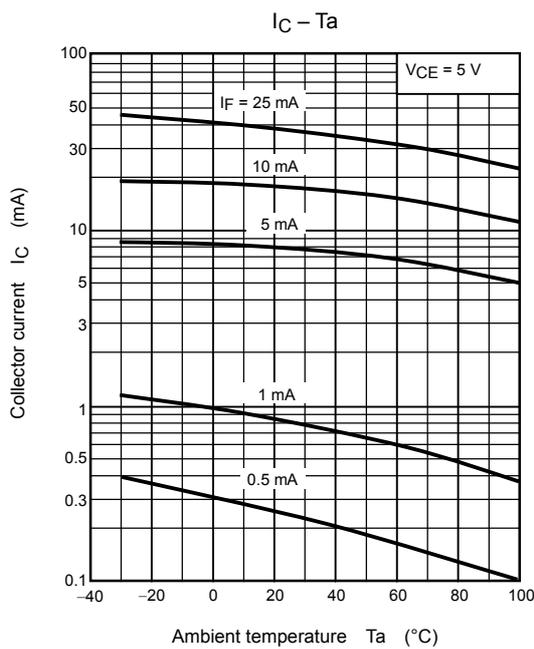
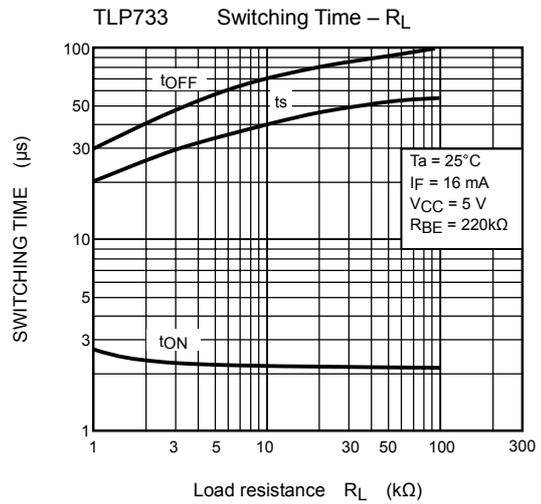
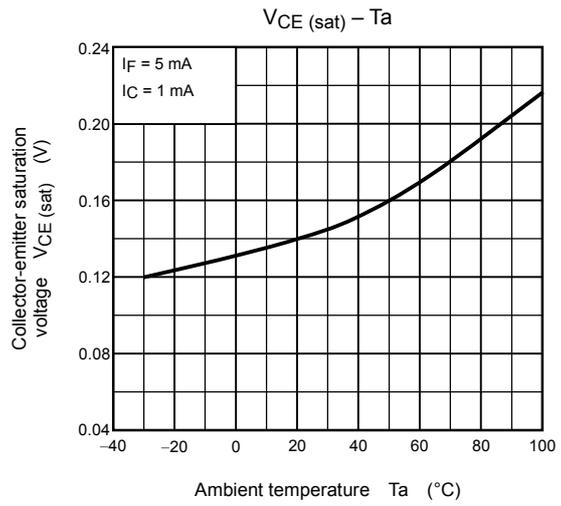
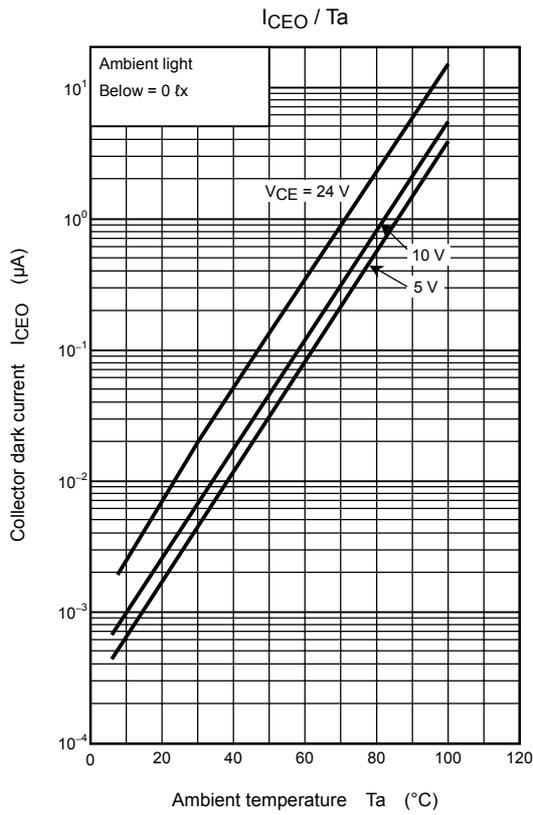

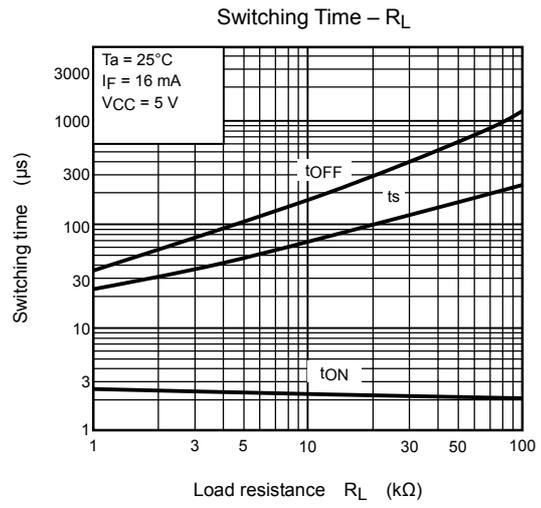
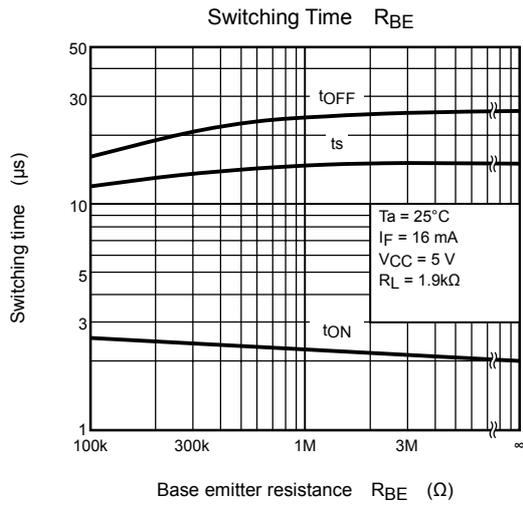

RESTRICTIONS ON PRODUCT USE

000707EAA

- TOSHIBA is continually working to improve the quality and reliability of its products. Nevertheless, semiconductor devices in general can malfunction or fail due to their inherent electrical sensitivity and vulnerability to physical stress. It is the responsibility of the buyer, when utilizing TOSHIBA products, to comply with the standards of safety in making a safe design for the entire system, and to avoid situations in which a malfunction or failure of such TOSHIBA products could cause loss of human life, bodily injury or damage to property.
In developing your designs, please ensure that TOSHIBA products are used within specified operating ranges as set forth in the most recent TOSHIBA products specifications. Also, please keep in mind the precautions and conditions set forth in the "Handling Guide for Semiconductor Devices," or "TOSHIBA Semiconductor Reliability Handbook" etc..
- The TOSHIBA products listed in this document are intended for usage in general electronics applications (computer, personal equipment, office equipment, measuring equipment, industrial robotics, domestic appliances, etc.). These TOSHIBA products are neither intended nor warranted for usage in equipment that requires extraordinarily high quality and/or reliability or a malfunction or failure of which may cause loss of human life or bodily injury ("Unintended Usage"). Unintended Usage include atomic energy control instruments, airplane or spaceship instruments, transportation instruments, traffic signal instruments, combustion control instruments, medical instruments, all types of safety devices, etc.. Unintended Usage of TOSHIBA products listed in this document shall be made at the customer's own risk.
- The information contained herein is presented only as a guide for the applications of our products. No responsibility is assumed by TOSHIBA CORPORATION for any infringements of intellectual property or other rights of the third parties which may result from its use. No license is granted by implication or otherwise under any intellectual property or other rights of TOSHIBA CORPORATION or others.
- The information contained herein is subject to change without notice.

This datasheet has been download from:

www.datasheetcatalog.com

Datasheets for electronics components.