

64-BIT AC-PDP DRIVER

The μ PD16337 is a high-voltage CMOS driver designed for flat display panels such as PDPs, VFDs and ELs. It consists of a 64-bit bi-directional shift register (16 bit \times 4 circuits), 64-bit latch and high-voltage CMOS driver. The logic block is designed to operate at 5-V power supply, enabling direct connection to a microcontroller. In addition, the μ PD16337 achieves low power dissipation by employing CMOS structure while having a high withstand voltage output (150 V, 40 mA MAX.)

FEATURES

- Built in four 16-bit bi-directional shift register circuits
- Data control with transfer clock (external) and latch
- High-speed data transfer ($f_{max.} = 20$ MHz MIN. at cascade connection)
- Wide operating temperature range ($T_A = -40$ to $+85^\circ\text{C}$)
- High withstand output voltage (150 V, 40 mA MAX.)
- 5-V CMOS input interface
- High withstand voltage CMOS structure
- Capable of reversing all driver outputs by PC pin

ORDERING INFORMATION

Part Number	Package
μ PD16337GF-3BA	100-pin plastic QFP

BLOCK DIAGRAM

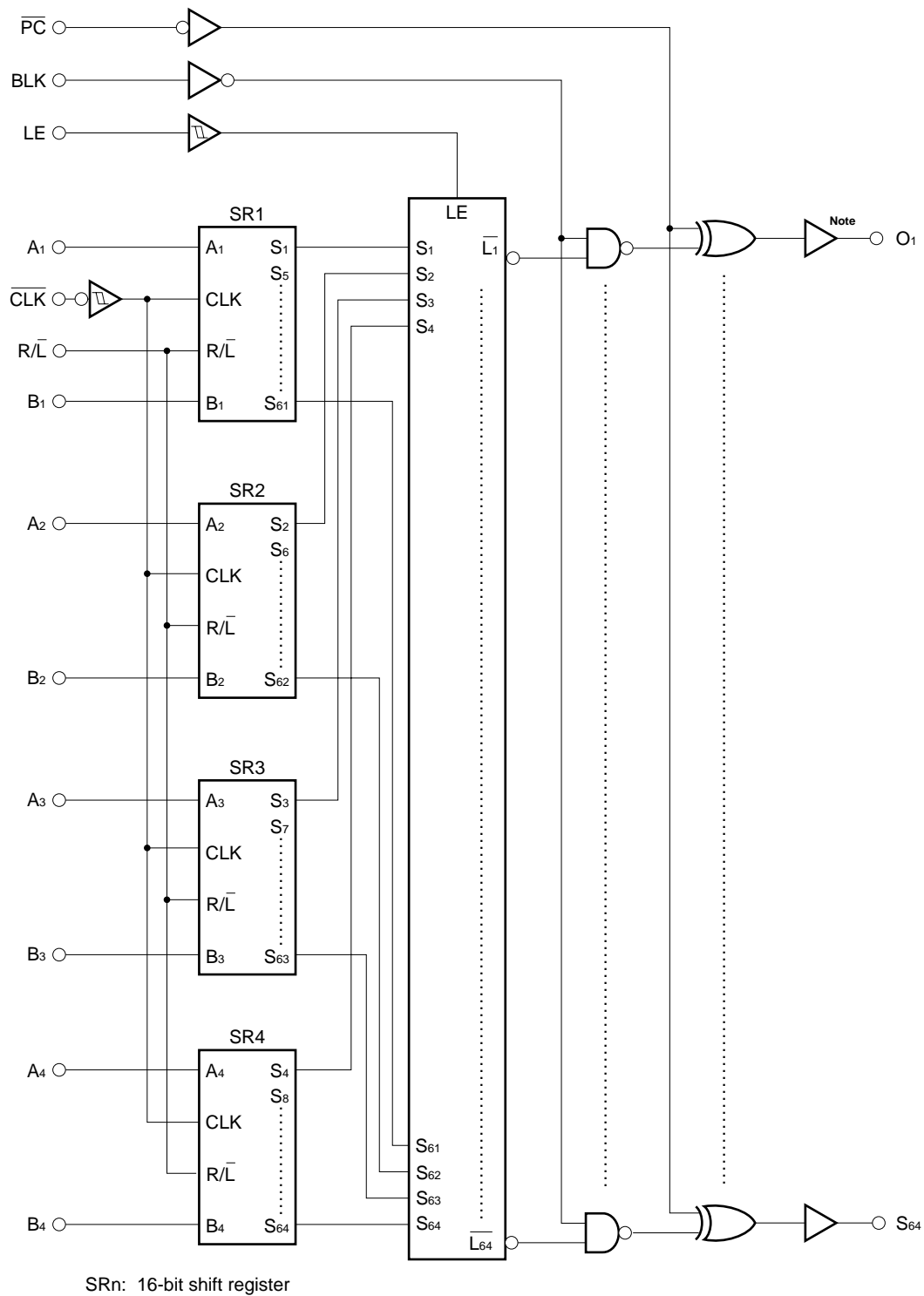

Note High withstand voltage CMOS driver, 150 V, ±40 mA (MAX.)

PIN CONFIGURATION (Top View)

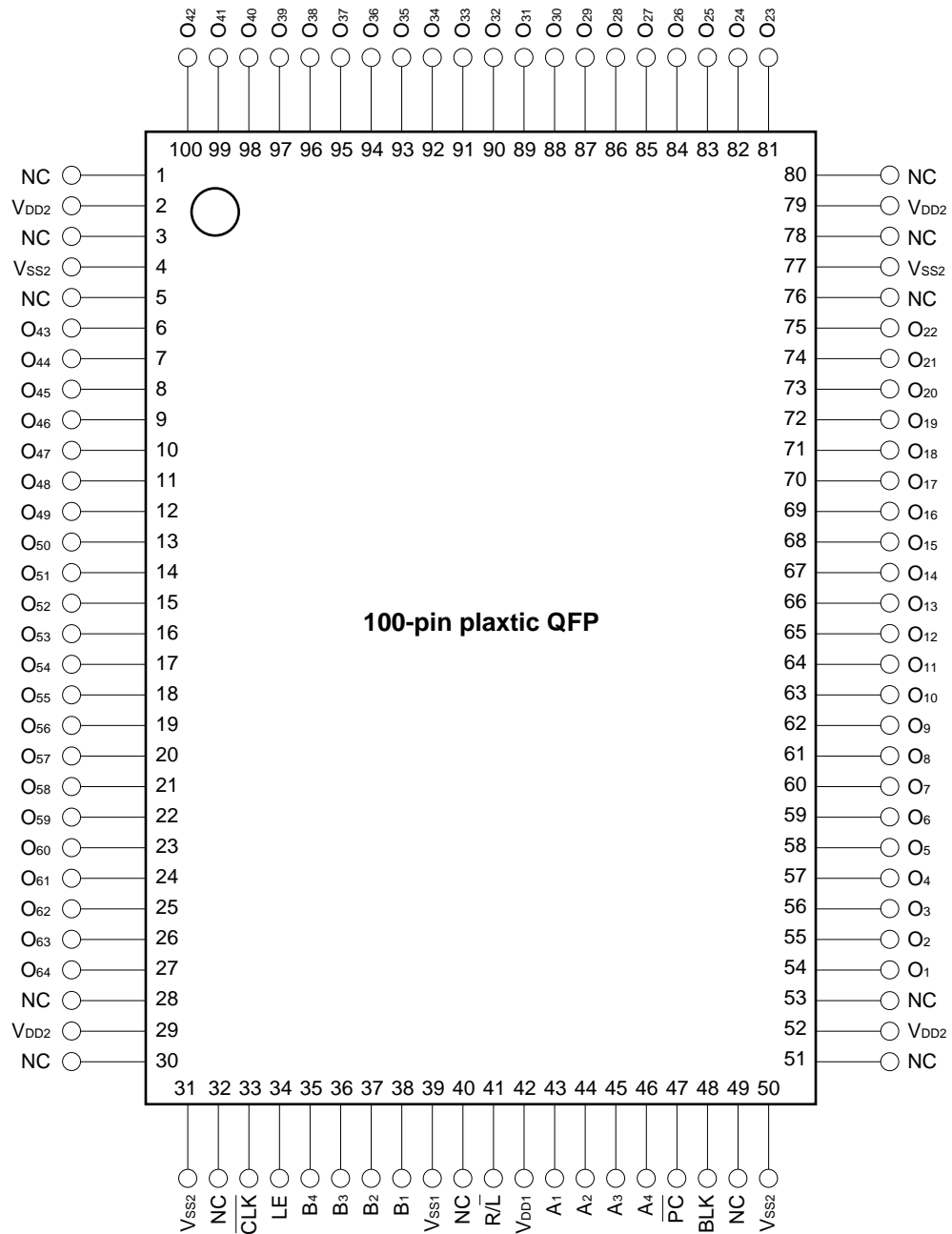

- Cautions**
1. Pin 40 is connected to the lead frame, and therefore must be left open.
 2. Ensure that the V_{DD1}, V_{DD2}, V_{SS1} and V_{SS2} pins are all used, and that V_{SS1} and V_{SS2} are used at the same potential.
 3. To prevent latch up breakdown, the power should be turned on in the order V_{DD1}, logic signal, V_{DD2}. It should be turned off in the opposite order.

PIN DESCRIPTION

Symbol	Pin Name	Pin Number	Description
\overline{PC}	Polarity change input	47	$\overline{PC} = L$: All driver output invert
BLK	Blank input	48	BLK = H: All output = H or L
LE	Latch enable input	34	Automatically executes latch by setting High at rising edge of the clock
A ₁ to A ₄	RIGHT data input/output	43 to 46	When $\overline{R/L} = H$, A ₁ to A ₄ : Input B ₁ to B ₄ : Output
B ₁ to B ₄	LEFT data input/output	38 to 35	When $\overline{R/L} = L$, A ₁ to A ₄ : Output B ₁ to B ₄ : Input
\overline{CLK}	Clock input	33	Shift executed on fall
$\overline{R/L}$	Shift control input	41	Right shift mode when R/L = H SR ₁ : A ₁ → S ₁ ... S ₆₁ → B ₁ (Same direction for SR ₂ -SR ₄) Left shift mode when R/L = L SR ₁ : B ₁ → S ₆₁ ... S ₁ → A ₁ (Same direction for SR ₂ -SR ₄)
O ₁ to O ₆₄	High withstand voltage output	54 to 75, 81 to 100, 6 to 27	130 V, 40 mA MAX.
V _{DD1}	Power supply for logic block	42	5 V ±10%
V _{DD2}	Power supply for driver block	2, 29, 52, 79	30 to 130 V
V _{SS1}	Logic GND	39	Connect to system GND
V _{SS2}	Driver GND	4, 31, 50, 77	Connect to system GND
NC	Non-connection	1, 3, 5, 28, 30, 32, 40, 49, 51, 53, 76, 78, 80	Non-connection Ensure that pin 40 is left open.

TRUTH TABLE 1 (Shift Register Block)

Input		Output		Shift Register
R/L	CLK	A	B	
H	↓	Input	Output ^{Note 1}	Right shift execution
H	H or L		Output	Hold
L	↓	Output ^{Note 2}	Input	Left shift execution
L	H or L	Output		Hold

- Notes**
1. The data of S₅₇, S₅₈, S₅₉, S₆₀ shifts to S₆₁, S₆₂, S₆₃, S₆₄ and is output from B₁, B₂, B₃, B₄ at the falling edge of the clock, respectively.
 2. The data of S₅, S₆, S₇, S₈ shifts to S₁, S₂, S₃, S₄ and is output from A₁, A₂, A₃, A₄ at the falling edge of the clock, respectively.

TRUTH TABLE 2 (Latch Block)

LE	CLK	Output State of Latch Block (\overline{L}_n)
H	↑	Latch S _n data and hold output data
	↓	Hold latch data
L	×	Hold latch data

TRUTH TABLE 3 (Driver Block)

\overline{L}_n	BLK	\overline{PC}	Output State of Driver Block
×	H	H	H (All driver outputs: H)
×	H	L	L (All driver outputs: L)
×	L	H	Output latch data (\overline{L}_n)
×	L	L	Output reversed latch data (\overline{L}_n)

×: H or L, H: High level, L: Low level

TIMING CHART (Right shift)

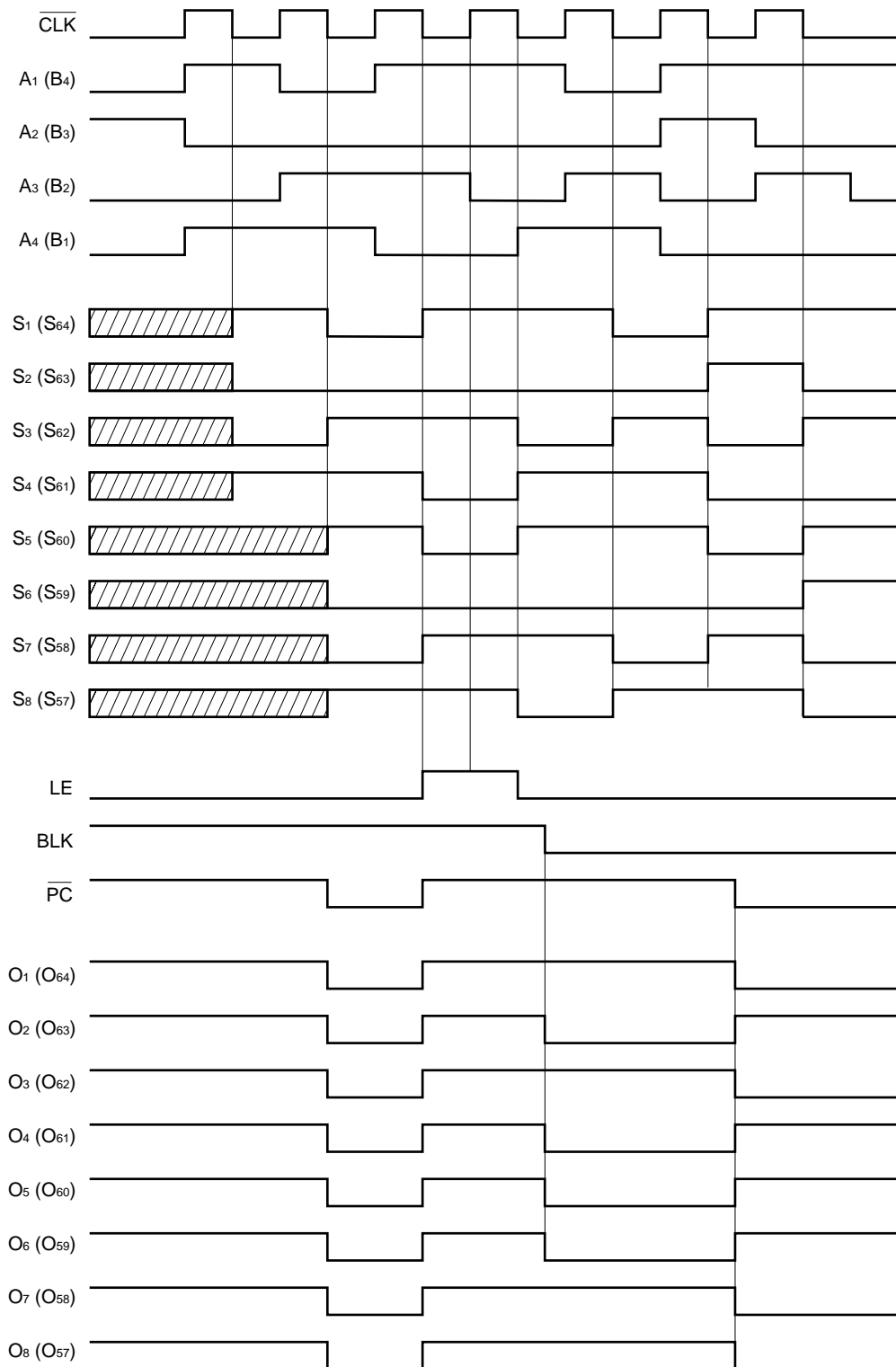

Remark Values in parentheses in the above chart are when $R/\bar{L} = L$.

ABSOLUTE MAXIMUM RATINGS (T_A = 25°C, V_{SS1} = V_{SS2} = 0 V)

Parameter	Symbol	Ratings	Unit
Logic Block Supply Voltage	V _{DD1}	-0.5 to +7.0	V
Driver Block Supply Voltage	V _{DD2}	-0.5 to +150	V
Logic Block Input Voltage	V _I	-0.5 to V _{DD1} + 0.5	V
Driver Block Output Current	I _{O2}	40	mA
Input Current	I _I	±25	mA
Power Dissipation	P _D	1300 ^{Note}	mW
Operating Ambient Temperature	T _A	-40 to +85	°C
Storage Temperature	T _{stg}	-65 to +150	°C

Note Derate at -13 mW/°C at T_A = 25°C or higher

RECOMMENDED OPERATING CONDITIONS (T_A = -40 to +85°C, V_{SS1} = V_{SS2} = 0 V)

Parameter	Symbol	MIN.	TYP.	MAX.	Unit
Logic Block Supply Voltage	V _{DD1}	4.5	5.0	5.5	V
Driver Block Supply Voltage	V _{DD2}	30		130	V
High-Level Input Voltage	V _{IH}	0.7 V _{DD1}		V _{DD1}	V
Low-Level Input Voltage	V _{IL}	0		0.2 V _{DD1}	V
Driver Output Current	I _{OH2}			-30	mA
	I _{OL2}			+30	mA

ELECTRICAL SPECIFICATIONS (T_A = 25°C, V_{DD1} = 5.0 V, V_{DD2} = 130 V, V_{SS1} = V_{SS2} = 0 V)

Parameter	Symbol	Condition	MIN.	TYP.	MAX.	Unit
High-Level Output Voltage	V _{OH1}	Logic, I _{OH1} = -1.0 mA	0.9 V _{DD1}		V _{DD1}	V
Low-Level Output Voltage	V _{OL1}	Logic, I _{OL1} = 1.0 mA	0		0.1 V _{DD1}	V
High-Level Output Voltage	V _{OH21}	O ₁ to O ₆₄ , I _{OH2} = -10 mA	123			V
	V _{OH22}	O ₁ to O ₆₄ , I _{OH2} = -30 mA	110			V
Low-Level Output Voltage	V _{OL21}	O ₁ to O ₆₄ , I _{OL2} = 10 mA			5.0	V
	V _{OL22}	O ₁ to O ₆₄ , I _{OL2} = 30 mA			15	V
Input Leakage Current	I _{IL}	V ₁ = V _{DD1} or V _{SS1}			±1.0	μA
High-Level Input Voltage	V _{IH}		0.7 V _{DD1}			V
Low-Level Input Voltage	V _{IL}				0.2 V _{DD1}	V
Static Current Dissipation	I _{DD1}	Logic, T _A = -40 to +85°C			100	μA
	I _{DD1}	Logic, T _A = 25°C			10	μA
	I _{DD2}	Driver, T _A = -40 to +85°C			1000	μA
	I _{DD2}	Driver, T _A = 25°C			100	μA

SWITCHING CHARACTERISTICS ($T_A = 25^\circ\text{C}$, $V_{DD1} = 5.0\text{ V}$, $V_{DD2} = 130\text{ V}$, $V_{SS1} = V_{SS2} = 0\text{ V}$, logic $C_L = 15\text{ pF}$, driver $C_L = 50\text{ pF}$, $t_r = t_f = 6.0\text{ ns}$)

Parameter	Symbol	Conditions	MIN.	TYP.	MAX.	Unit
Transmission Delay Time	t_{PHL1}	$\overline{\text{CLK}} \downarrow \rightarrow \text{A/B}$			40	ns
	t_{PLH1}				40	ns
	t_{PHL2}	$\overline{\text{CLK}} \uparrow (\text{LE} = \text{H}) \rightarrow \text{O}_1 \text{ to } \text{O}_{64}$			180	ns
	t_{PLH2}				180	ns
	t_{PHL3}	$\text{BLK} \rightarrow \text{O}_1 \text{ to } \text{O}_{64}$			165	ns
	t_{PLH3}				165	ns
	t_{PHL4}	$\overline{\text{PC}} \rightarrow \text{O}_1 \text{ to } \text{O}_{64}$			160	ns
	t_{PLH4}				160	ns
Rise Time	t_{TLH}	$\text{O}_1 \text{ to } \text{O}_{64}$			200	ns
Fall Time	t_{THL}	$\text{O}_1 \text{ to } \text{O}_{64}$			200	ns
Maximum Clock Frequency	f_{max}	When data is read, duty 50% $T_A = -40 \text{ to } +85^\circ\text{C}$ $V_{DD1} = 4.5 \text{ to } 5.5\text{ V}$	25			MHz
		When a cascade connection is made with a duty of 50% $T_A = -40 \text{ to } +85^\circ\text{C}$ $V_{DD1} = 4.5 \text{ to } 5.5\text{ V}$	20			MHz
Input Capacitance	C_i				15	pF

TIMMING REQUIREMENT ($T_A = -40 \text{ to } +85^\circ\text{C}$, $V_{DD1} = 4.5 \text{ to } 5.5\text{ V}$, $V_{SS1} = V_{SS2} = 0\text{ V}$, $t_r = t_f = 6.0\text{ ns}$)

Parameter	Symbol	Conditions	MIN.	TYP.	MAX.	Unit
Clock Pulse Width	$PW_{\overline{\text{CLK}}}$		20			ns
Latch Enable Pulse Width	PW_{LE}		30			ns
Blank Pulse Width	PW_{BLK}		500			ns
$\overline{\text{PC}}$ Pulse Width	$PW_{\overline{\text{PC}}}$		500			ns
Data Setup Time	t_{setup}		10			ns
Data Hold Time	t_{hold}		10			ns
Latch Enable Time 1	t_{LE1}		20			ns
Latch Enable Time 2	t_{LE2}		10			ns
Latch Enable Time 3	t_{LE3}		20			ns
Latch Enable Time 4	t_{LE4}		10			ns

SWITCHING CHARACTERISTICS WAVEFORM

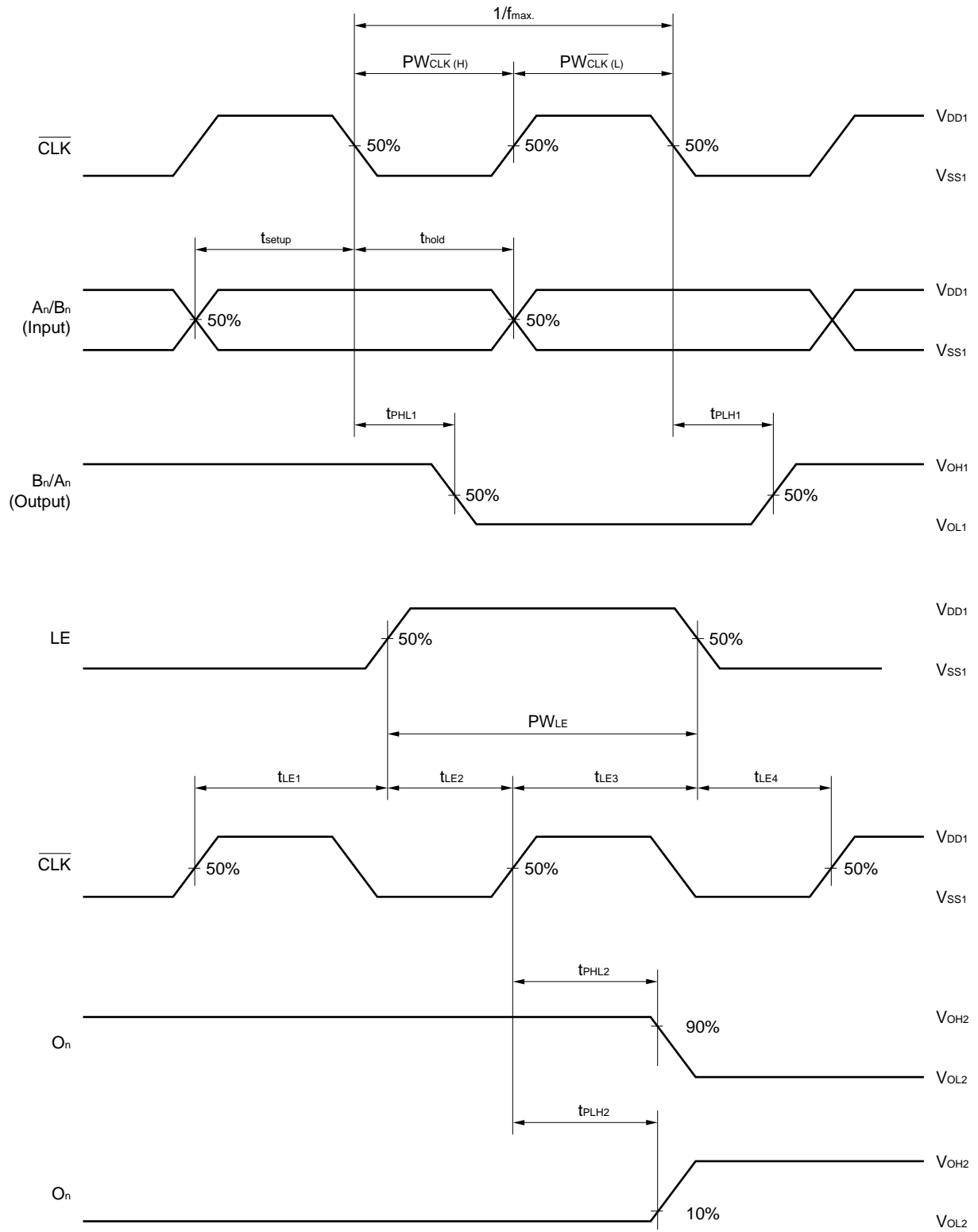

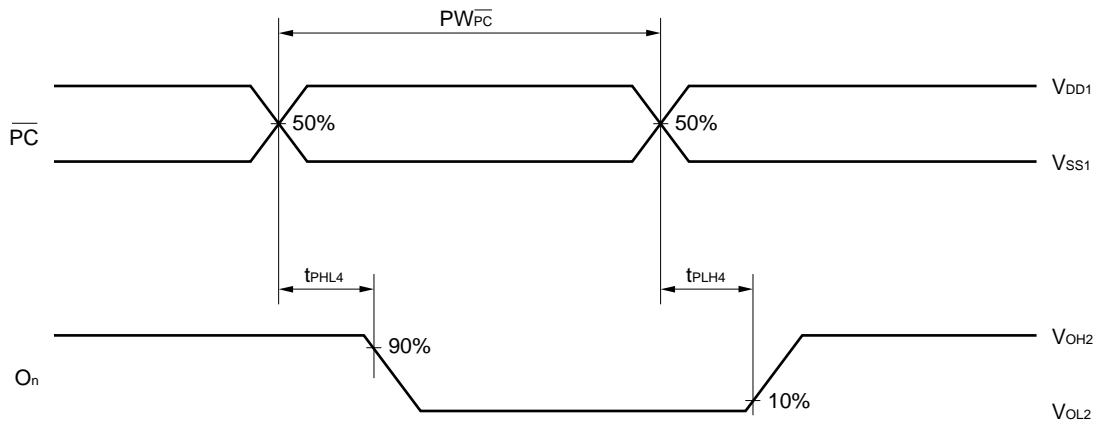
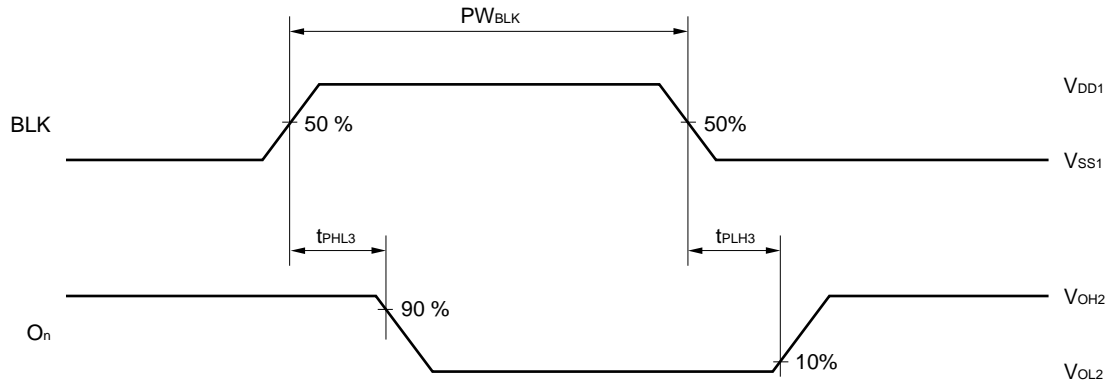

PACKAGE DRAWINGS

100 PIN PLASTIC QFP (14×20)

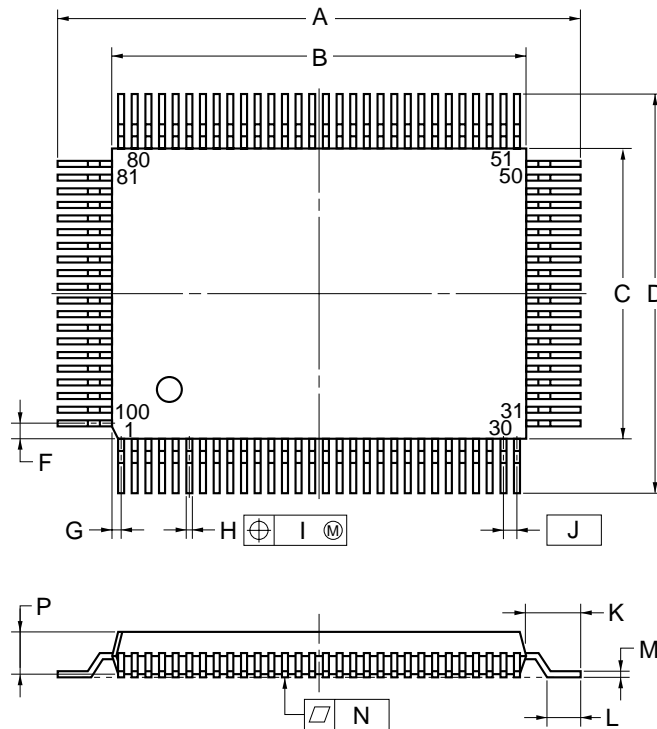

detail of lead end

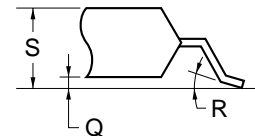

NOTE

Each lead centerline is located within 0.15 mm (0.006 inch) of its true position (T.P.) at maximum material condition.

ITEM	MILLIMETERS	INCHES
A	23.2±0.2	0.913 ^{+0.009} _{-0.008}
B	20.0±0.2	0.787 ^{+0.009} _{-0.008}
C	14.0±0.2	0.551 ^{+0.009} _{-0.008}
D	17.2±0.2	0.677±0.008
F	0.8	0.031
G	0.6	0.024
H	0.30±0.10	0.012 ^{+0.004} _{-0.005}
I	0.15	0.006
J	0.65 (T.P.)	0.026 (T.P.)
K	1.6±0.2	0.063±0.008
L	0.8±0.2	0.031 ^{+0.009} _{-0.008}
M	0.15 ^{+0.10} _{-0.05}	0.006 ^{+0.004} _{-0.003}
N	0.10	0.004
P	2.7	0.106
Q	0.125±0.075	0.005±0.003
R	5°±5°	5°±5°
S	3.0 MAX.	0.119 MAX.

S100GF-65-3BA-3

RECOMMENDED SOLDERING CONDITIONS

This product should be soldered and mounted under the conditions recommended below.

For soldering methods and conditions other than those recommended, please contact your NEC sales representative.

SURFACE MOUNT TYPE

For details of recommended soldering conditions, refer to the information document “Semiconductor Device Mounting Technology Manual” (C10535E).

μPD16337GF-3BA

Soldering Method	Soldering Conditions	Recommended Condition Symbol
Infrared reflow	Package peak temperature: 230°C, Duration: 30 sec. MAX. (at 210°C or above), Number of times: Twice, Time limit: None ^{Note}	IR30-00-2
VPS	Package peak temperature: 215°C, Duration: 40 sec. MAX. (at 200°C or above), Number of times: Twice, Time limit: None ^{Note}	VP15-00-2
Pin partial heating	Pin partial temperature: 300°C MAX., Duration: 10 sec. MAX., Time limit: None ^{Note}	

Note For the storage period after dry-pack decapsulation, storage conditions are max. 25°C, 65% RH.

Caution Use of more than one soldering method should be avoided (except in the case of pin partial heating).

REFERENCES

NEC Semiconductor Device Reliability/Quality Control System (IEI-1212)
Quality Grade on NEC Semiconductor Devices (C11531E)

[MEMO]

[MEMO]

[MEMO]

No part of this document may be copied or reproduced in any form or by any means without the prior written consent of NEC Corporation. NEC Corporation assumes no responsibility for any errors which may appear in this document.

NEC Corporation does not assume any liability for infringement of patents, copyrights or other intellectual property rights of third parties by or arising from use of a device described herein or any other liability arising from use of such device. No license, either express, implied or otherwise, is granted under any patents, copyrights or other intellectual property rights of NEC Corporation or others.

While NEC Corporation has been making continuous effort to enhance the reliability of its semiconductor devices, the possibility of defects cannot be eliminated entirely. To minimize risks of damage or injury to persons or property arising from a defect in an NEC semiconductor device, customers must incorporate sufficient safety measures in its design, such as redundancy, fire-containment, and anti-failure features.

NEC devices are classified into the following three quality grades:

"Standard", "Special", and "Specific". The Specific quality grade applies only to devices developed based on a customer designated "quality assurance program" for a specific application. The recommended applications of a device depend on its quality grade, as indicated below. Customers must check the quality grade of each device before using it in a particular application.

Standard: Computers, office equipment, communications equipment, test and measurement equipment, audio and visual equipment, home electronic appliances, machine tools, personal electronic equipment and industrial robots

Special: Transportation equipment (automobiles, trains, ships, etc.), traffic control systems, anti-disaster systems, anti-crime systems, safety equipment and medical equipment (not specifically designed for life support)

Specific: Aircrafts, aerospace equipment, submersible repeaters, nuclear reactor control systems, life support systems or medical equipment for life support, etc.

The quality grade of NEC devices is "Standard" unless otherwise specified in NEC's Data Sheets or Data Books. If customers intend to use NEC devices for applications other than those specified for Standard quality grade, they should contact an NEC sales representative in advance.

Anti-radioactive design is not implemented in this product.