

<b>SANYO</b>	No.4802	<b>2SC5155</b>
		NPN Epitaxial Planar Silicon Transistor Low-Frequency General-Purpose Amp Applications

**Applications**

- Various drivers.

**Features**

- High current capacity.
- Adoption of MBIT process.
- High DC current gain.
- Low collector-to-emitter saturation voltage.
- High  $V_{EBO}$ .

**Absolute Maximum Ratings at  $T_a = 25^\circ\text{C}$**

			unit
Collector-to-Base Voltage	$V_{CB0}$	50	V
Collector-to-Emitter Voltage	$V_{CEO}$	20	V
Emitter-to-Base Voltage	$V_{EBO}$	15	V
Collector Current	$I_C$	3	A
Collector Current (Pulse)	$I_{CP}$	6	A
Base Current	$I_B$	0.6	A
Collector Dissipation	$P_C$	1	W
		20	W
Junction Temperature	$T_j$	150	$^\circ\text{C}$
Storage Temperature	$T_{stg}$	-55 to +150	$^\circ\text{C}$

$T_c = 25^\circ\text{C}$

**Electrical Characteristics at  $T_a = 25^\circ\text{C}$**

			min	typ	max	unit
Collector Cutoff Current	$I_{CBO}$	$V_{CB} = 30\text{V}, I_E = 0$			100	nA
Emitter Cutoff Current	$I_{EBO}$	$V_{EB} = 10\text{V}, I_C = 0$			100	nA
DC Current Gain	$h_{FE(1)}$	$V_{CE} = 2\text{V}, I_C = 500\text{mA}$	800	1500	3200	
	$h_{FE(2)}$	$V_{CE} = 2\text{V}, I_C = 2\text{A}$	500			
Gain-Bandwidth Product	$f_T$	$V_{CE} = 2\text{V}, I_C = 500\text{mA}$		260		MHz
Output Capacitance	$C_{ob}$	$V_{CB} = 10\text{V}, f = 1\text{MHz}$		35		pF
C-E Saturation Voltage	$V_{CE(sat)}$	$I_C = 2\text{A}, I_B = 20\text{mA}$	0.15	0.5		V
B-E Saturation Voltage	$V_{BE(sat)}$	$I_C = 2\text{A}, I_B = 20\text{mA}$	0.85	1.2		V
C-B Breakdown Voltage	$V_{(BR)CBO}$	$I_C = 10\mu\text{A}, I_E = 0$	50			V
C-E Breakdown Voltage	$V_{(BR)CEO}$	$I_C = 1\text{mA}, R_{BE} = \infty$	20			V
E-B Breakdown Voltage	$V_{(BR)EBO}$	$I_E = 10\mu\text{A}, I_C = 0$	15			V
Turn-ON time	$t_{on}$	See specified Test Circuit.		0.14		$\mu\text{s}$
Storage Time	$t_{stg}$	"		1.5		$\mu\text{s}$
Fall Time	$t_f$	"		0.12		$\mu\text{s}$

**Switching Time Test Circuit**

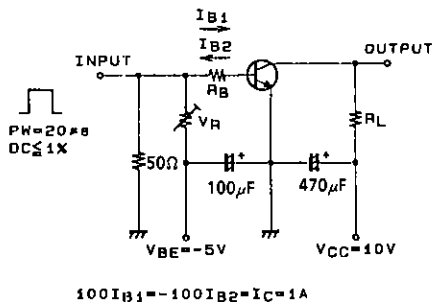

**Package Dimensions 2045A**  
(unit: mm)

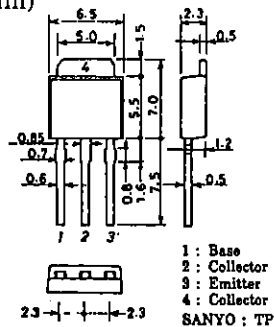

**Package Dimensions 2044A**  
(unit: mm)

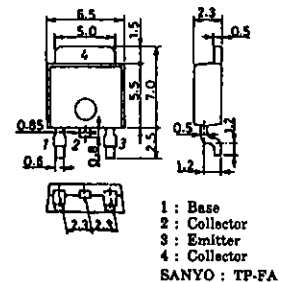

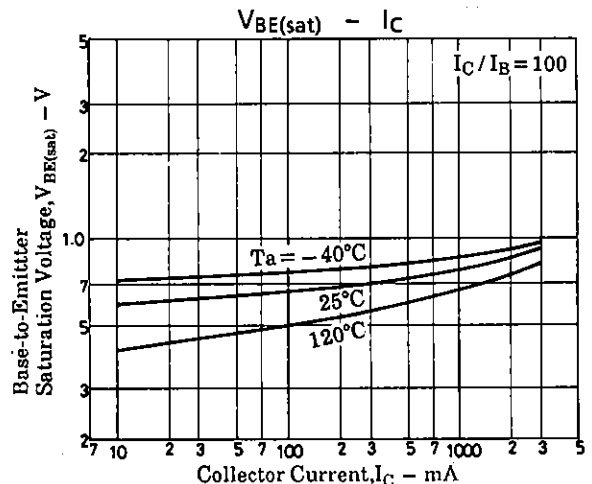
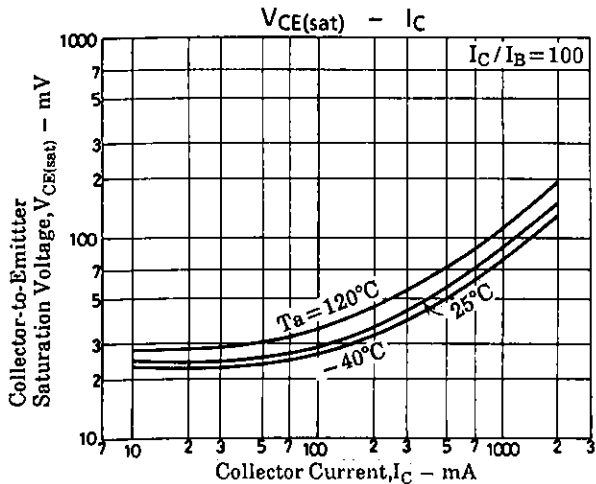
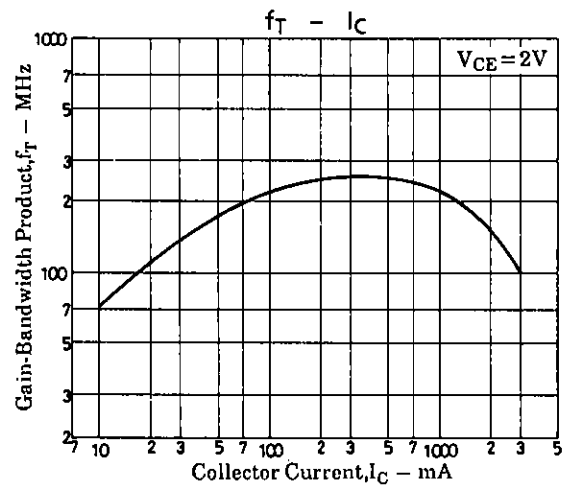
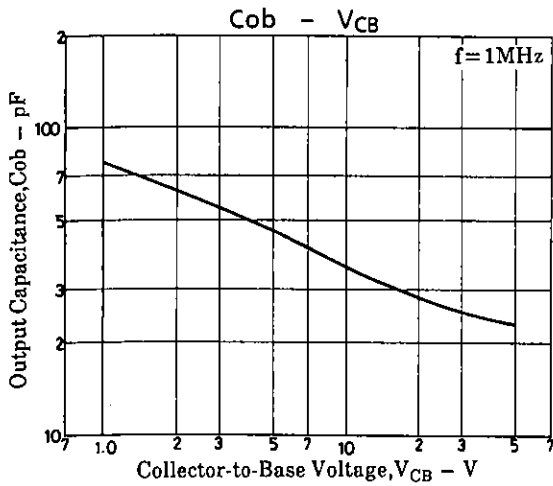
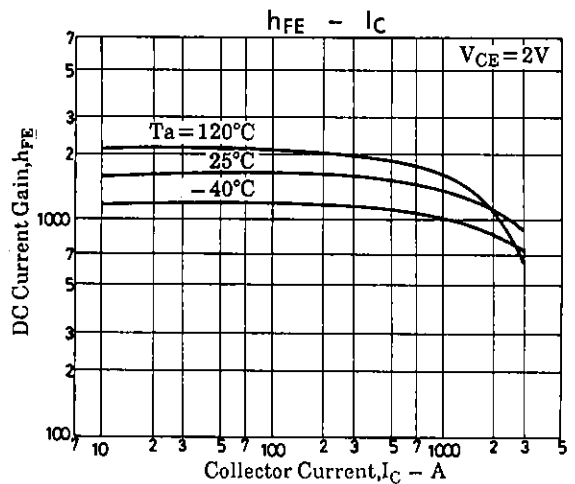
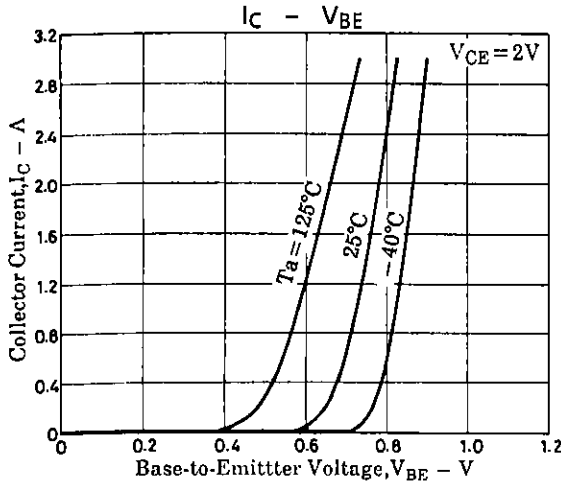
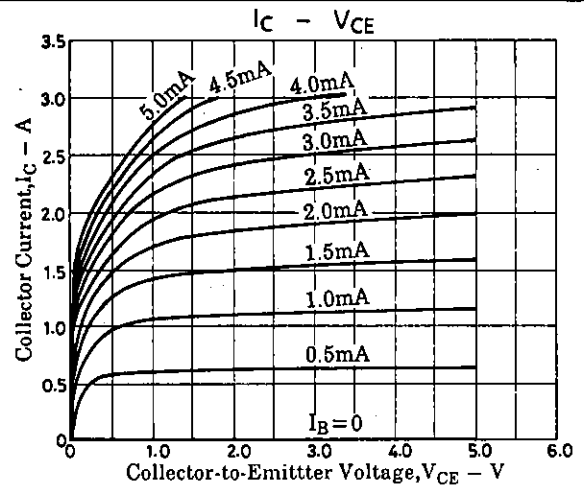
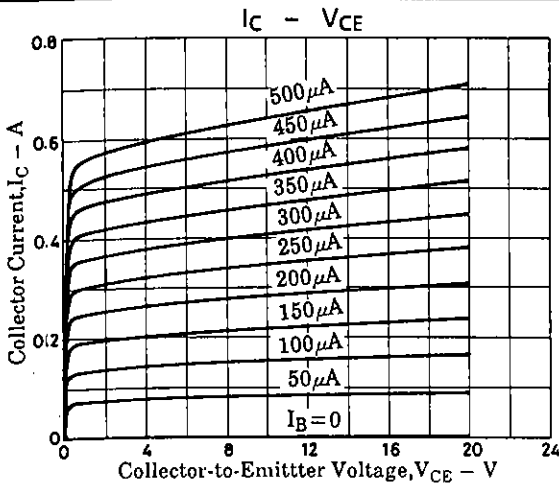

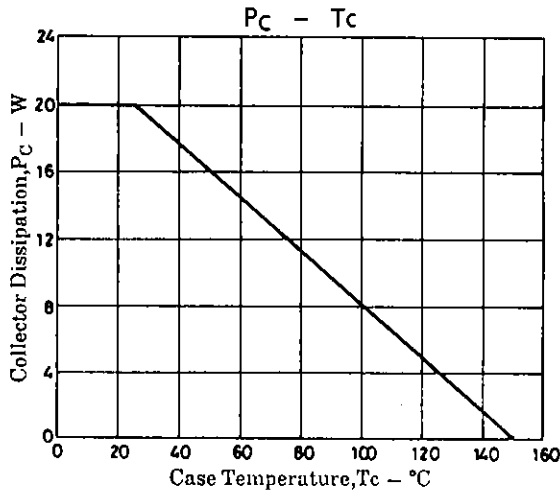
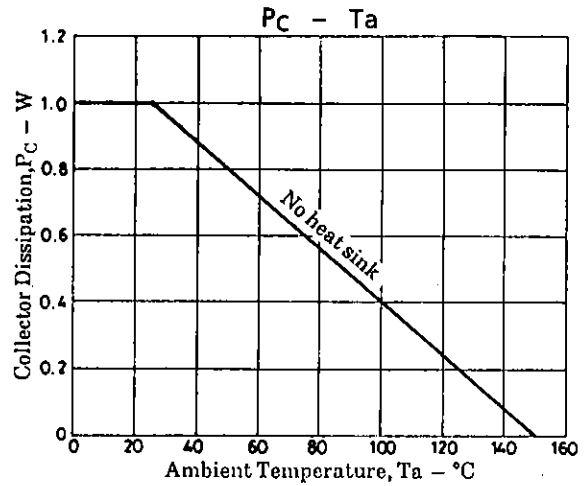
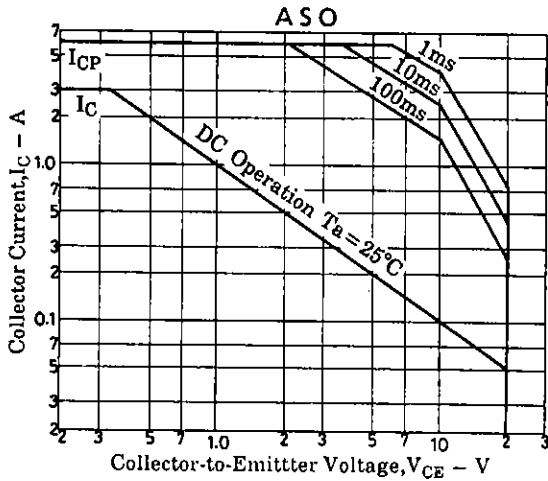

■ No products described or contained herein are intended for use in surgical implants, life-support systems, aerospace equipment, nuclear power control systems, vehicles, disaster/crime-prevention equipment and the like, the failure of which may directly or indirectly cause injury, death or property loss.

■ Anyone purchasing any products described or contained herein for an above-mentioned use shall:

- ① Accept full responsibility and indemnify and defend SANYO ELECTRIC CO., LTD., its affiliates, subsidiaries and distributors and all their officers and employees, jointly and severally, against any and all claims and litigation and all damages, cost and expenses associated with such use;
- ② Not impose any responsibility for any fault or negligence which may be cited in any such claim or litigation on SANYO ELECTRIC CO., LTD., its affiliates, subsidiaries and distributors or any of their officers and employees jointly or severally.

■ Information (including circuit diagrams and circuit parameters) herein is for example only; it is not guaranteed for volume production. SANYO believes information herein is accurate and reliable, but no guarantees are made or implied regarding its use or any infringements of intellectual property rights or other rights of third parties.