

P-CHANNEL MOS FET
FOR SWITCHING

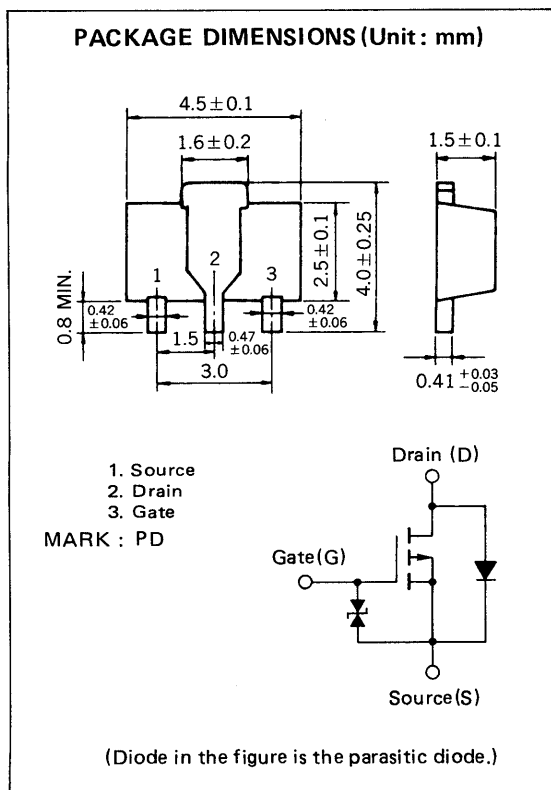

The 2SJ205, P-channel vertical type MOS FET, is a switching device which can be driven by 3 V power supply.

As the MOS FET is driven by low voltage and does not require consideration of driving current, it is suitable for appliances including VCR cameras and headphone stereos which need power saving.

FEATURES

- Directly driven by ICs having a 3 V power supply.
- Not necessary to consider driving current because of its high input impedance.
- Possible to reduce the number of parts by omitting the bias resistor.
- Has low on-state resistance
 $R_{DS(on)} = 5.0 \Omega \text{ MAX. @ } V_{GS} = -2.5 \text{ V, } I_D = -10 \text{ mA}$
 $R_{DS(on)} = 3.0 \Omega \text{ MAX. @ } V_{GS} = -4 \text{ V, } I_D = -300 \text{ mA}$

QUALITY GRADE

Standard

Please refer to "Quality grade on NEC Semiconductor Devices" (Document number IEI-1209) published by NEC Corporation to know the specification of quality grade on the devices and its recommended applications.

ABSOLUTE MAXIMUM RATINGS ($T_a = 25^\circ\text{C}$)

PARAMETER	SYMBOL	RATINGS	UNIT	TEST CONDITIONS
Drain to Source Voltage	V_{DSS}	-16	V	$V_{GS} = 0$
Gate to Source Voltage	V_{GSS}	± 16	V	$V_{DS} = 0$
Drain Current	$I_D(\text{DC})$	± 500	mA	
Drain Current	$I_D(\text{pulse})$	± 1.0	A	$PW \leq 10 \text{ ms, Duty Cycle} \leq 50 \%$
Total Power Dissipation	P_T	2.0	W	When using ceramic board of $16 \text{ cm}^2 \times 0.7 \text{ mm}$
Channel Temperature	T_{ch}	150	$^\circ\text{C}$	
Operating Temperature	T_{opt}	-55 to +80	$^\circ\text{C}$	
Storage Temperature	T_{stg}	-55 to +150	$^\circ\text{C}$	

ELECTRICAL CHARACTERISTICS (T_a = 25 °C)

PARAMETER	SYMBOL	MIN.	TYP.	MAX.	UNIT	TEST CONDITIONS
Drain Cut-off Current	I _{DSS}			-1.0	μA	V _{DS} = -16 V, V _{GS} = 0
Gate Leakage Current	I _{GS}			±5	μA	V _{GS} = ±16 V, V _{DS} = 0
Gate Cut-off Voltage	V _{GS(off)}	-1.4	-1.9	-2.4	V	V _{DS} = -5 V, I _D = -10 μA
Forward Transfer Admittance	y _{fs}	0.4	0.5		S	V _{DS} = -3 V, I _D = -0.3 A
Drain to Source On-State Resistance	R _{DS(on)1}		3.0	5.0	Ω	V _{GS} = -2.5 V, I _D = -10 mA
Drain to Source On-State Resistance	R _{DS(on)2}		1.5	3.0	Ω	V _{GS} = -4 V, I _D = -0.3 A
Input Capacitance	C _{iss}		105		pF	V _{DS} = -3.0 V, V _{GS} = 0, f = 1 MHz
Output Capacitance	C _{oss}		90		pF	
Feedback Capacitance	C _{rss}		15		pF	
Turn-On Delay Time	t _{d(on)}		185		ns	V _{GS(on)} = -3 V, R _G = 10 Ω, V _{DD} = -3 V, I _D = -0.3 A, R _L = 10 Ω
Rise Time	t _r		900		ns	
Turn-Off Delay Time	t _{d(off)}		40		ns	
Fall Time	t _f		135		ns	

TYPICAL CHARACTERISTICS (T_a = 25 °C)

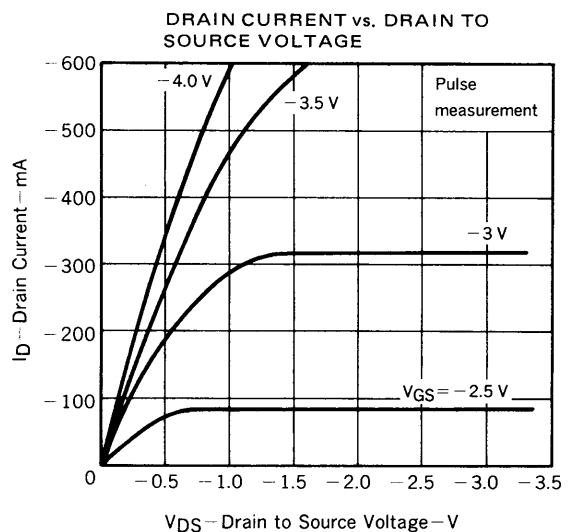
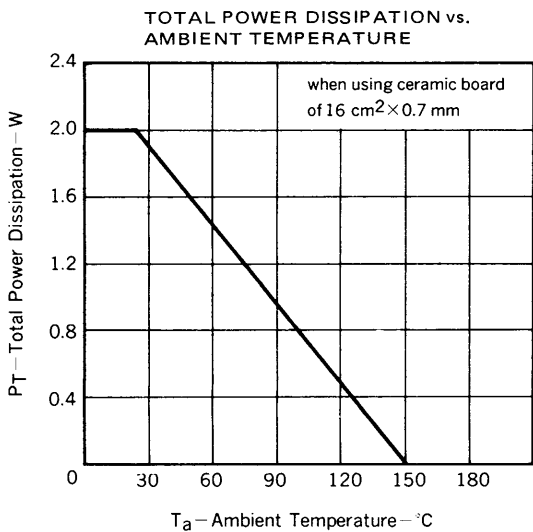
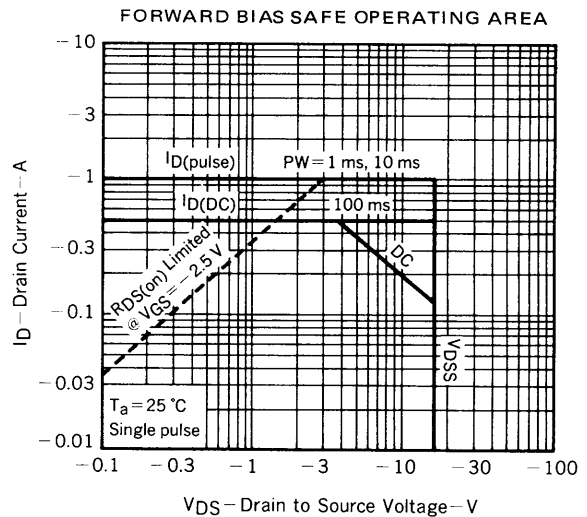
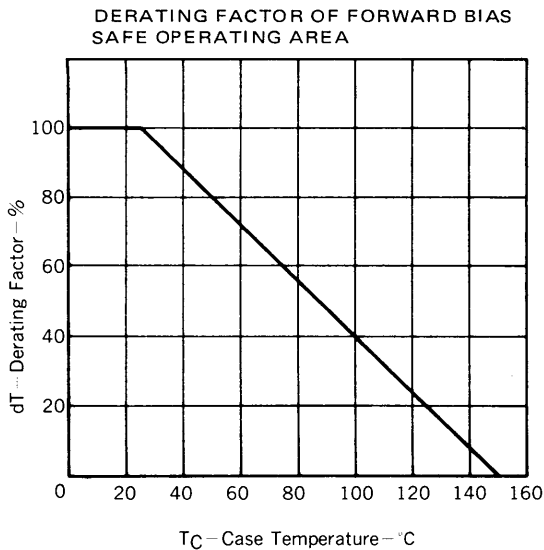

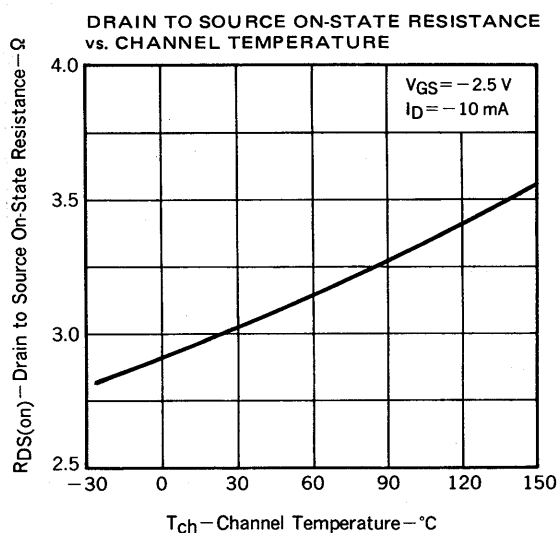
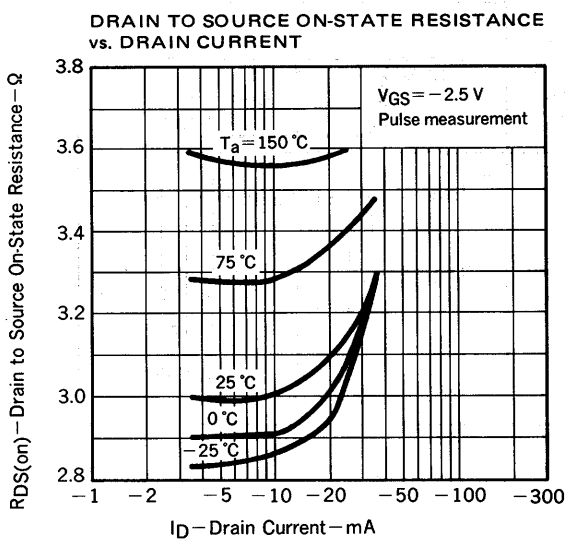
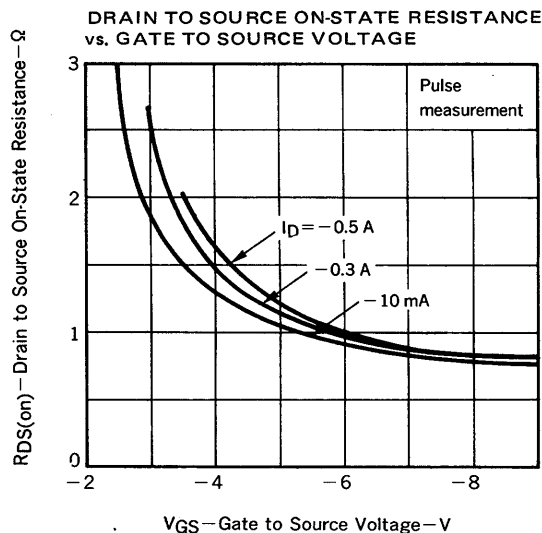
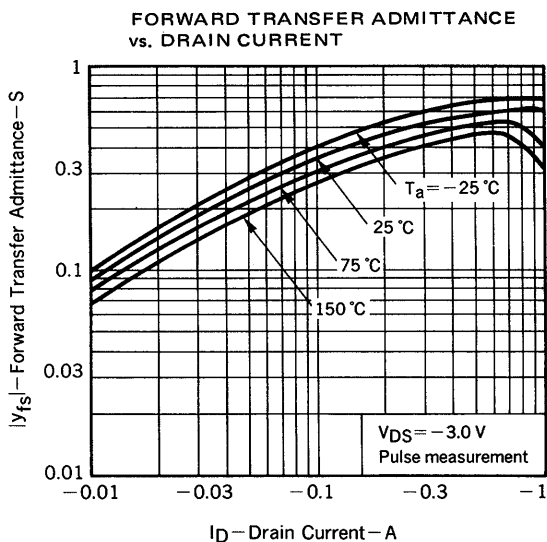
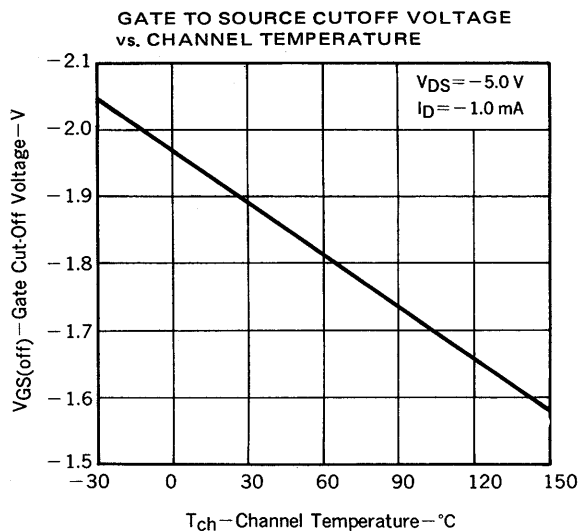
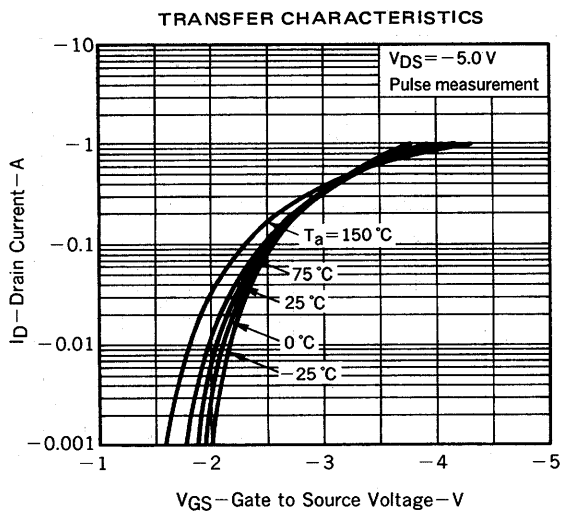

CAPACITANCE vs. DRAIN TO SOURCE VOLTAGE

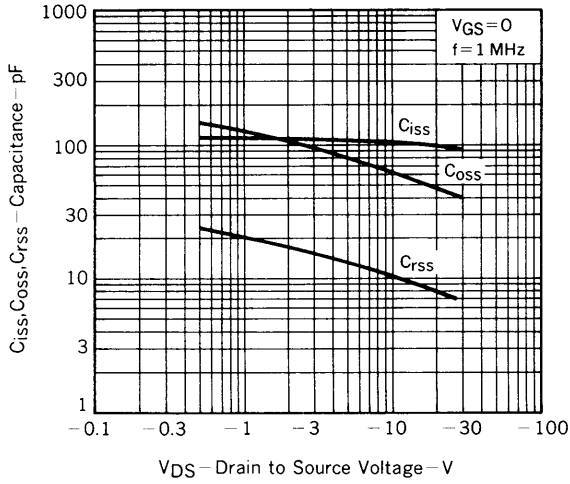

SWITCHING CHARACTERISTICS

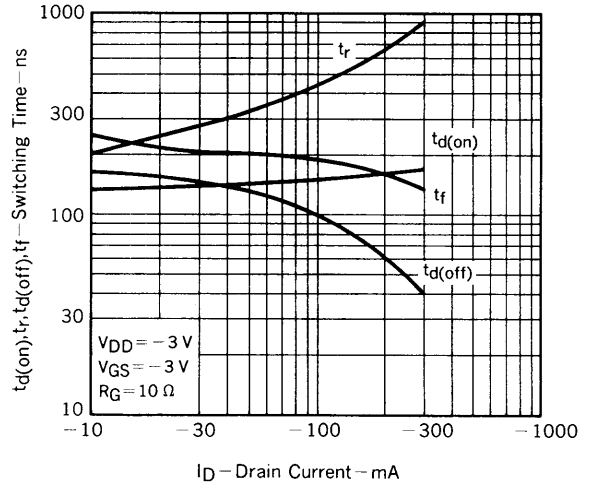

SOURCE TO DRAIN DIODE FORWARD VOLTAGE

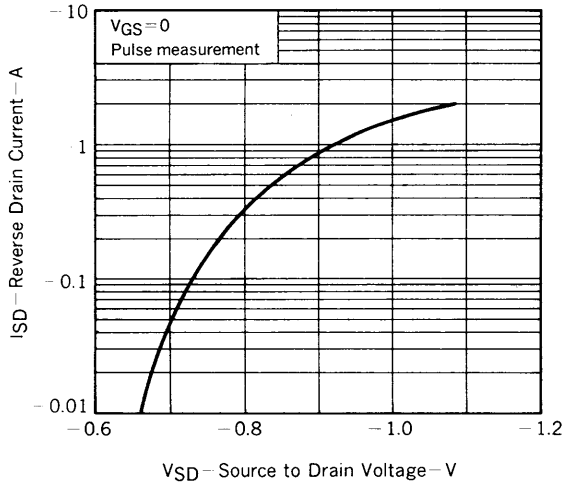

SWITCHING TIME MEASUREMENT CIRCUIT AND CONDITIONS

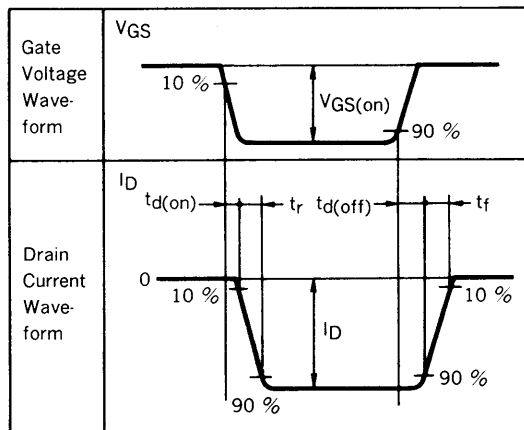
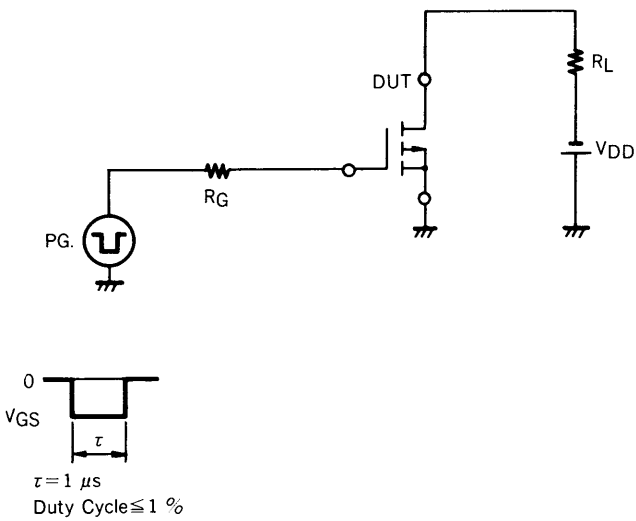

RECOMMENDED SOLDERING CONDITIONS

Mounting of this product by soldering should be done under the following conditions.
Please consult with our representatives about soldering methods and conditions other than these recommended.

SURFACE MOUNT TYPE

For details of the recommended soldering conditions, see the information document.
"Device Mounting Manual for Surface Mounting (IEI-1207)."

Soldering Method	Soldering Conditions	Symbol for Recommended Conditions
Infrared Reflow	Package peak temp.: 230 °C Soldering time: within 30 sec (above 210°C) Soldering times: 1, Days limitation: none*	IR30-00
Vapor Phase Soldering	Package peak temp.: 215 °C Soldering time: within 40 sec (above 200°C) Soldering times: 1, Days limitation: none*	VP15-00
Wave Soldering	Soldering bath temp.: below 260 °C Soldering time: within 10 sec Soldering times: 1, Days limitation: none*	WS60-00

* Stored days under storage conditions at 25 °C and below 65 % R.H. after dry-pack opened.

Note 1: Combination of soldering methods should be avoided.

REFERENCE

Document Name	Document No.
NEC semiconductor device reliability/quality control system.	TEI-1202
Quality grade on NEC semiconductor devices.	IEI-1209
Semiconductor device mounting technology manual.	IEI-1207
Semiconductor device package manual.	IEI-1213
Guide to quality assurance for semiconductor devices.	MEI-1202
Semiconductor selection guide.	MF-1134

[MEMO]

No part of this document may be copied or reproduced in any form or by any means without the prior written consent of NEC Corporation. NEC Corporation assumes no responsibility for any errors which may appear in this document.

NEC Corporation does not assume any liability for infringement of patents, copyrights or other intellectual property rights of third parties by or arising from use of a device described herein or any other liability arising from use of such device. No license, either express, implied or otherwise, is granted under any patents, copyrights or other intellectual property rights of NEC Corporation or others.

The devices listed in this document are not suitable for use in aerospace equipment, submarine cables, nuclear reactor control systems and life support systems. If customers intend to use NEC devices for above applications or they intend to use "Standard" quality grade NEC devices for applications not intended by NEC, please contact our sales people in advance.

Application examples recommended by NEC Corporation

Standard: Computer, Office equipment, Communication equipment, Test and Measurement equipment, Machine tools, Industrial robots, Audio and Visual equipment, Other consumer products, etc.

Special: Automotive and Transportation equipment, Traffic control systems, Antidisaster systems, Anticrime systems, etc.