

## FQP4N25

### 250V N-Channel MOSFET

#### General Description

These N-Channel enhancement mode power field effect transistors are produced using Fairchild's proprietary, planar stripe, DMOS technology.

This advanced technology has been especially tailored to minimize on-state resistance, provide superior switching performance, and withstand high energy pulse in the avalanche and commutation mode. These devices are well suited for high efficiency switching DC/DC converters, switch mode power supply.

#### Features

- 3.6A, 250V,  $R_{DS(on)} = 1.75\Omega @ V_{GS} = 10V$
- Low gate charge ( typical 4.3 nC)
- Low  $C_{rss}$  ( typical 4.8 pF)
- Fast switching
- 100% avalanche tested
- Improved dv/dt capability

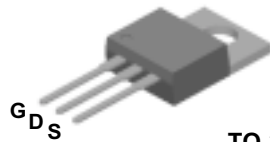

**TO-220**  
FQP Series

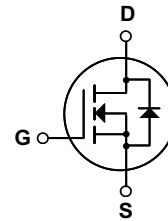

#### Absolute Maximum Ratings $T_C = 25^\circ\text{C}$ unless otherwise noted

| Symbol         | Parameter   | FQP4N25     | Units               |
|----------------|---|-------------|---------------------|
| $V_{DSS}$      | Drain-Source Voltage  | 250         | V                   |
| $I_D$          | Drain Current - Continuous ( $T_C = 25^\circ\text{C}$ )<br>- Continuous ( $T_C = 100^\circ\text{C}$ ) | 3.6         | A                   |
|                |   | 2.3         | A                   |
| $I_{DM}$       | Drain Current - Pulsed (Note 1)   | 14.4        | A                   |
| $V_{GSS}$      | Gate-Source Voltage   | $\pm 30$    | V                   |
| $E_{AS}$       | Single Pulsed Avalanche Energy (Note 2)   | 52          | mJ                  |
| $I_{AR}$       | Avalanche Current (Note 1)  | 3.6         | A                   |
| $E_{AR}$       | Repetitive Avalanche Energy (Note 1)  | 5.2         | mJ                  |
| dv/dt          | Peak Diode Recovery dv/dt (Note 3)  | 5.5         | V/ns                |
| $P_D$          | Power Dissipation ( $T_C = 25^\circ\text{C}$ )<br>- Derate above $25^\circ\text{C}$                   | 52          | W                   |
|                |   | 0.42        | W/ $^\circ\text{C}$ |
| $T_J, T_{STG}$ | Operating and Storage Temperature Range   | -55 to +150 | $^\circ\text{C}$    |
| $T_L$          | Maximum lead temperature for soldering purposes,<br>1/8" from case for 5 seconds                      | 300         | $^\circ\text{C}$    |

#### Thermal Characteristics

| Symbol          | Parameter                               | Typ | Max  | Units                     |
|-----------------|---|-----|------|---------------------------|
| $R_{\theta JC}$ | Thermal Resistance, Junction-to-Case    | --  | 2.4  | $^\circ\text{C}/\text{W}$ |
| $R_{\theta CS}$ | Thermal Resistance, Case-to-Sink        | 0.5 | --   | $^\circ\text{C}/\text{W}$ |
| $R_{\theta JA}$ | Thermal Resistance, Junction-to-Ambient | --  | 62.5 | $^\circ\text{C}/\text{W}$ |

## Electrical Characteristics

$T_C = 25^\circ\text{C}$  unless otherwise noted

| Symbol                         | Parameter                                 | Test Conditions   | Min | Typ  | Max  | Units                     |
|--------------------------------|---|---|-----|------|------|---------------------------|
| <b>Off Characteristics</b>     |   |   |     |      |      |                           |
| $BV_{DSS}$                     | Drain-Source Breakdown Voltage            | $V_{GS} = 0\text{ V}, I_D = 250\ \mu\text{A}$               | 250 | --   | --   | V                         |
| $\Delta BV_{DSS} / \Delta T_J$ | Breakdown Voltage Temperature Coefficient | $I_D = 250\ \mu\text{A}$ , Referenced to $25^\circ\text{C}$ | --  | 0.22 | --   | $\text{V}/^\circ\text{C}$ |
| $I_{DSS}$                      | Zero Gate Voltage Drain Current           | $V_{DS} = 250\text{ V}, V_{GS} = 0\text{ V}$                | --  | --   | 1    | $\mu\text{A}$             |
|                                |   | $V_{DS} = 200\text{ V}, T_C = 125^\circ\text{C}$            | --  | --   | 10   | $\mu\text{A}$             |
| $I_{GSSF}$                     | Gate-Body Leakage Current, Forward        | $V_{GS} = 30\text{ V}, V_{DS} = 0\text{ V}$                 | --  | --   | 100  | nA                        |
| $I_{GSSR}$                     | Gate-Body Leakage Current, Reverse        | $V_{GS} = -30\text{ V}, V_{DS} = 0\text{ V}$                | --  | --   | -100 | nA                        |

### On Characteristics

|              |                                   |   |     |      |      |          |
|--------------|-----------------------------------|---|-----|------|------|----------|
| $V_{GS(th)}$ | Gate Threshold Voltage            | $V_{DS} = V_{GS}, I_D = 250\ \mu\text{A}$           | 3.0 | --   | 5.0  | V        |
| $R_{DS(on)}$ | Static Drain-Source On-Resistance | $V_{GS} = 10\text{ V}, I_D = 1.8\text{ A}$          | --  | 1.38 | 1.75 | $\Omega$ |
| $g_{FS}$     | Forward Transconductance          | $V_{DS} = 50\text{ V}, I_D = 1.8\text{ A}$ (Note 4) | --  | 2.5  | --   | S        |

### Dynamic Characteristics

|           |                              |  |    |     |     |    |
|-----------|------------------------------|--|----|-----|-----|----|
| $C_{iss}$ | Input Capacitance            | $V_{DS} = 25\text{ V}, V_{GS} = 0\text{ V},$<br>$f = 1.0\text{ MHz}$ | -- | 155 | 200 | pF |
| $C_{oss}$ | Output Capacitance           |  | -- | 35  | 45  | pF |
| $C_{rss}$ | Reverse Transfer Capacitance |  | -- | 4.8 | 6.5 | pF |

### Switching Characteristics

|              |                     |  |  |     |     |     |    |
|--------------|---------------------|--|--|-----|-----|-----|----|
| $t_{d(on)}$  | Turn-On Delay Time  | $V_{DD} = 125\text{ V}, I_D = 3.6\text{ A},$<br>$R_G = 25\ \Omega$ | --   | 6.8 | 25  | ns  |    |
| $t_r$        | Turn-On Rise Time   |  | --   | 45  | 100 | ns  |    |
| $t_{d(off)}$ | Turn-Off Delay Time |  | (Note 4, 5)  | --  | 6.4 | 25  | ns |
| $t_f$        | Turn-Off Fall Time  |  | (Note 4, 5)  | --  | 22  | 55  | ns |
| $Q_g$        | Total Gate Charge   |  | $V_{DS} = 200\text{ V}, I_D = 3.6\text{ A},$<br>$V_{GS} = 10\text{ V}$ | --  | 4.3 | 5.6 | nC |
| $Q_{gs}$     | Gate-Source Charge  | (Note 4, 5)  | --   | 1.3 | --  | nC  |    |
| $Q_{gd}$     | Gate-Drain Charge   | (Note 4, 5)  | --   | 2.1 | --  | nC  |    |

### Drain-Source Diode Characteristics and Maximum Ratings

|          |   |  |    |      |     |               |
|----------|---|--|----|------|-----|---------------|
| $I_S$    | Maximum Continuous Drain-Source Diode Forward Current | --   | -- | 3.6  | A   |               |
| $I_{SM}$ | Maximum Pulsed Drain-Source Diode Forward Current     | --   | -- | 14.4 | A   |               |
| $V_{SD}$ | Drain-Source Diode Forward Voltage                    | $V_{GS} = 0\text{ V}, I_S = 3.6\text{ A}$  | -- | --   | 1.5 | V             |
| $t_{rr}$ | Reverse Recovery Time                                 | $V_{GS} = 0\text{ V}, I_S = 3.6\text{ A},$<br>$di_F / dt = 100\text{ A}/\mu\text{s}$ | -- | 110  | --  | ns            |
| $Q_{rr}$ | Reverse Recovery Charge                               | (Note 4)   | -- | 0.35 | --  | $\mu\text{C}$ |

#### Notes:

1. Repetitive Rating : Pulse width limited by maximum junction temperature
2.  $L = 6.4\text{ mH}, I_{AS} = 3.6\text{ A}, V_{DD} = 50\text{ V}, R_G = 25\ \Omega$ , Starting  $T_J = 25^\circ\text{C}$
3.  $I_{SD} \leq 3.6\text{ A}, di/dt \leq 300\text{ A}/\mu\text{s}, V_{DD} \leq BV_{DSS}$ , Starting  $T_J = 25^\circ\text{C}$
4. Pulse Test : Pulse width  $\leq 300\ \mu\text{s}$ , Duty cycle  $\leq 2\%$
5. Essentially independent of operating temperature

# Typical Characteristics

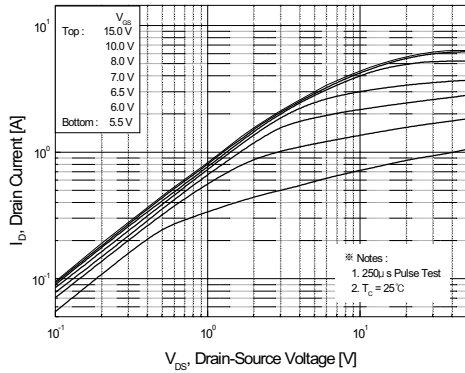

Figure 1. On-Region Characteristics

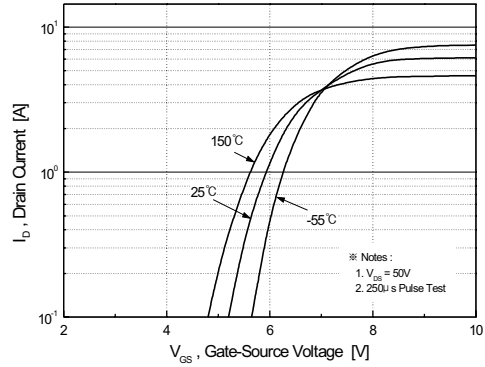

Figure 2. Transfer Characteristics

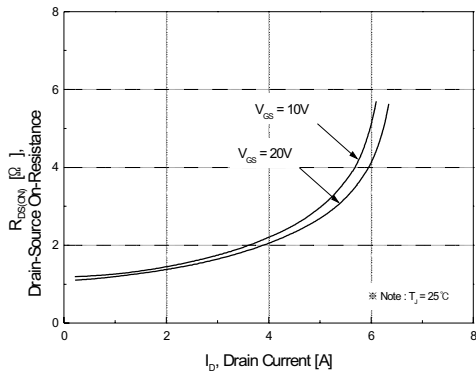

Figure 3. On-Resistance Variation vs. Drain Current and Gate Voltage

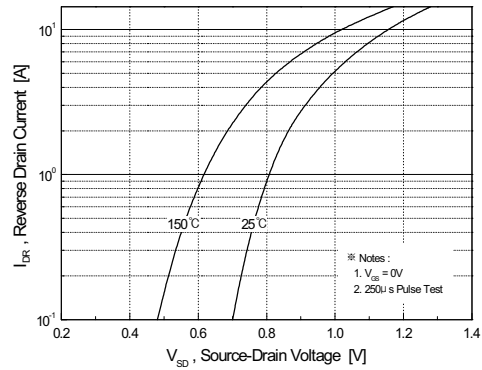

Figure 4. Body Diode Forward Voltage Variation vs. Source Current and Temperature

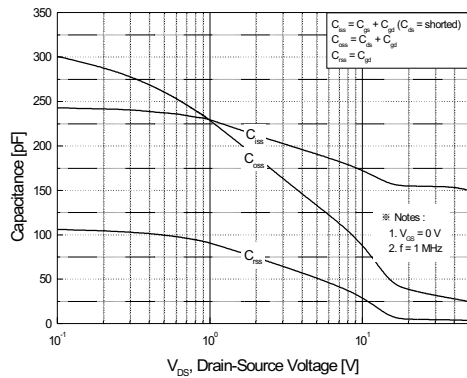

Figure 5. Capacitance Characteristics

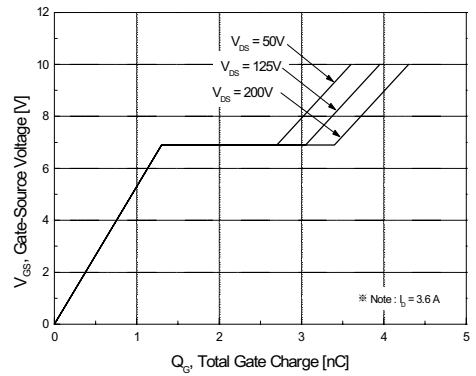

Figure 6. Gate Charge Characteristics

Typical Characteristics (Continued)

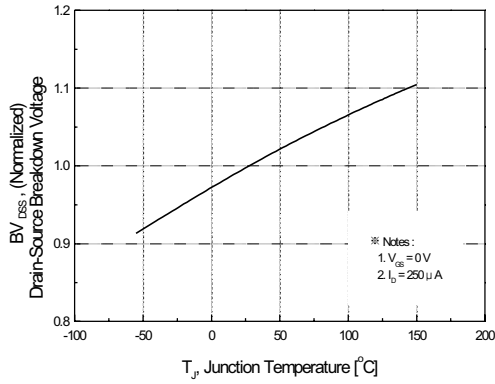

Figure 7. Breakdown Voltage Variation vs. Temperature

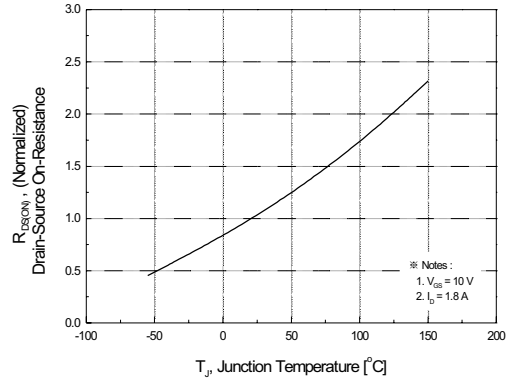

Figure 8. On-Resistance Variation vs. Temperature

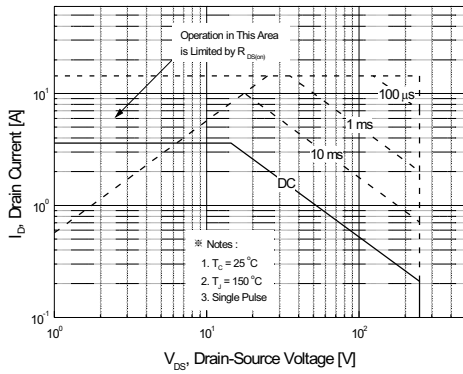

Figure 9. Maximum Safe Operating Area

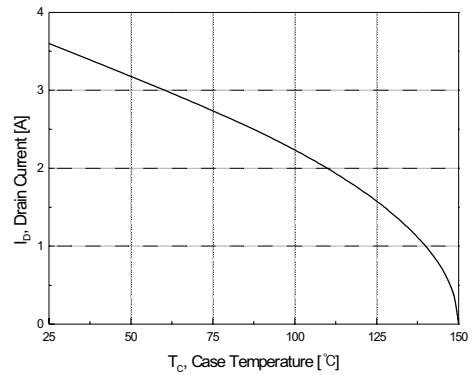

Figure 10. Maximum Drain Current vs. Case Temperature

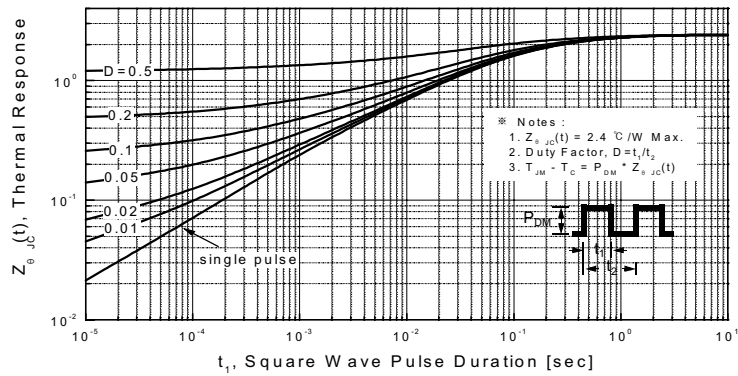
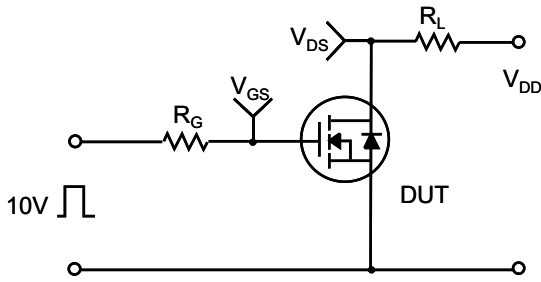

Figure 11. Transient Thermal Response Curve

Gate Charge Test Circuit & Waveform



Resistive Switching Test Circuit & Waveforms



Unclamped Inductive Switching Test Circuit & Waveforms

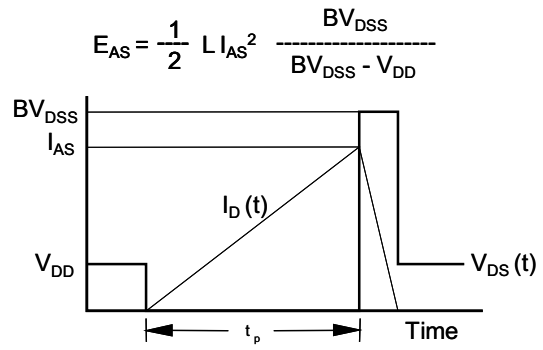

Peak Diode Recovery dv/dt Test Circuit & Waveforms

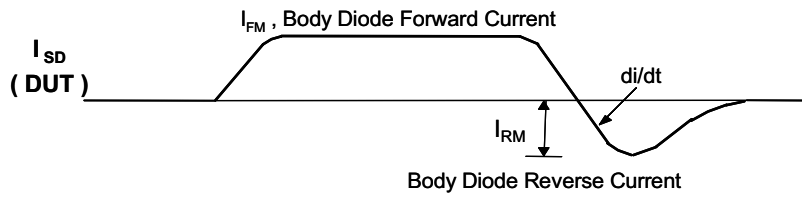

Package Dimensions

TO-220

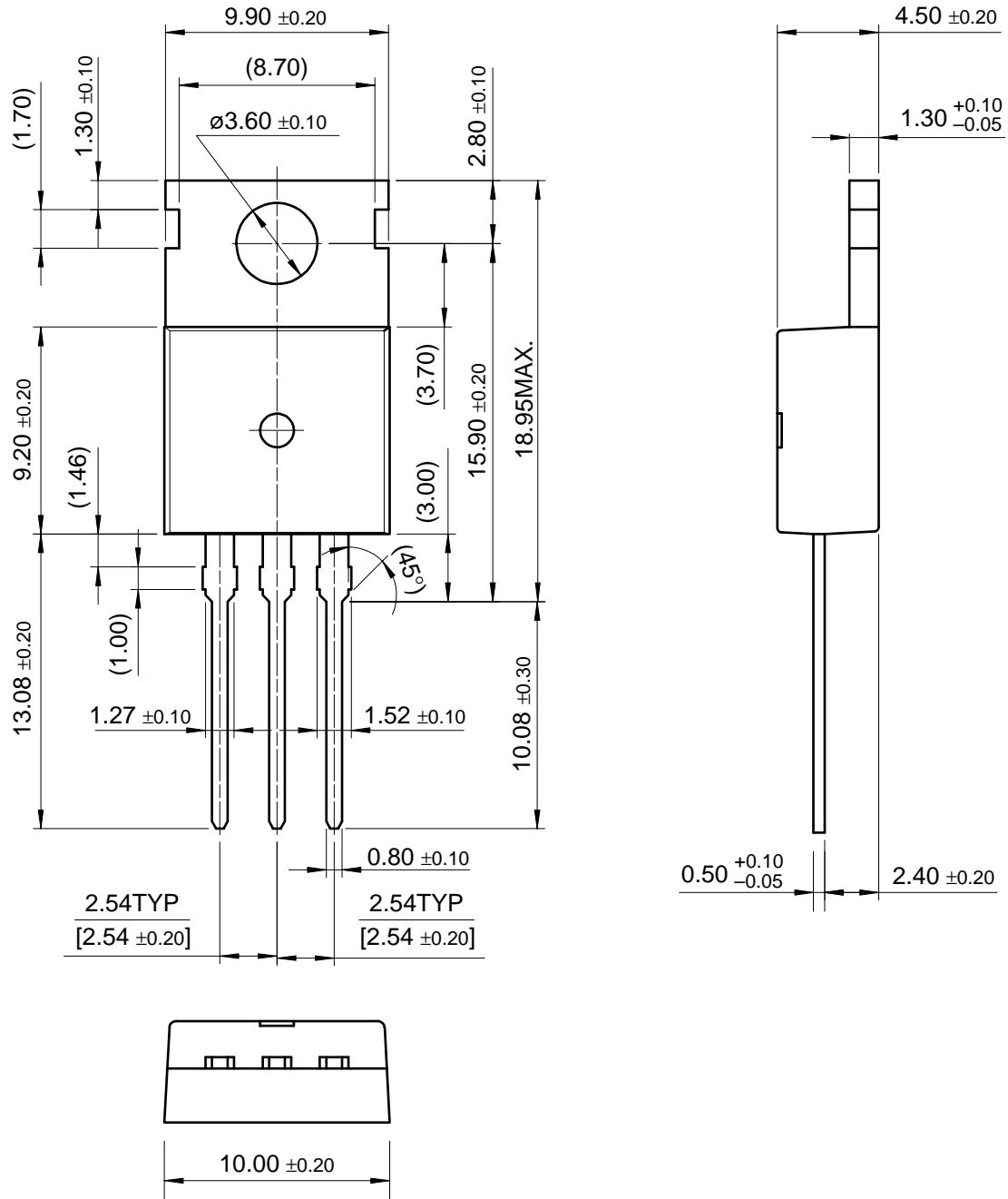

## TRADEMARKS

The following are registered and unregistered trademarks Fairchild Semiconductor owns or is authorized to use and is not intended to be an exhaustive list of all such trademarks.

|                                  |                           |                          |
|----------------------------------|---------------------------|--------------------------|
| ACE <sub>x</sub> <sup>™</sup>    | HiSeC <sup>™</sup>        | SuperSOT <sup>™</sup> -8 |
| Bottomless <sup>™</sup>          | ISOPLANAR <sup>™</sup>    | SyncFET <sup>™</sup>     |
| CoolFET <sup>™</sup>             | MICROWIRE <sup>™</sup>    | TinyLogic <sup>™</sup>   |
| CROSSVOLT <sup>™</sup>           | POP <sup>™</sup>          | UHC <sup>™</sup>         |
| E <sup>2</sup> CMOS <sup>™</sup> | PowerTrench <sup>®</sup>  | VCX <sup>™</sup>         |
| FACT <sup>™</sup>                | QFET <sup>™</sup>         |                          |
| FACT Quiet Series <sup>™</sup>   | QS <sup>™</sup>           |                          |
| FAST <sup>®</sup>                | Quiet Series <sup>™</sup> |                          |
| FAST <sub>r</sub> <sup>™</sup>   | SuperSOT <sup>™</sup> -3  |                          |
| GTO <sup>™</sup>                 | SuperSOT <sup>™</sup> -6  |                          |

## DISCLAIMER

FAIRCHILD SEMICONDUCTOR RESERVES THE RIGHT TO MAKE CHANGES WITHOUT FURTHER NOTICE TO ANY PRODUCTS HEREIN TO IMPROVE RELIABILITY, FUNCTION OR DESIGN. FAIRCHILD DOES NOT ASSUME ANY LIABILITY ARISING OUT OF THE APPLICATION OR USE OF ANY PRODUCT OR CIRCUIT DESCRIBED HEREIN; NEITHER DOES IT CONVEY ANY LICENSE UNDER ITS PATENT RIGHTS, NOR THE RIGHTS OF OTHERS.

## LIFE SUPPORT POLICY

FAIRCHILD'S PRODUCTS ARE NOT AUTHORIZED FOR USE AS CRITICAL COMPONENTS IN LIFE SUPPORT DEVICES OR SYSTEMS WITHOUT THE EXPRESS WRITTEN APPROVAL OF FAIRCHILD SEMICONDUCTOR INTERNATIONAL.

As used herein:

1. Life support devices or systems are devices or systems which, (a) are intended for surgical implant into the body, or (b) support or sustain life, or (c) whose failure to perform when properly used in accordance with instructions for use provided in the labeling, can be reasonably expected to result in significant injury to the user.
2. A critical component is any component of a life support device or system whose failure to perform can be reasonably expected to cause the failure of the life support device or system, or to affect its safety or effectiveness.

## PRODUCT STATUS DEFINITIONS

### Definition of Terms

| Datasheet Identification | Product Status         | Definition  |
|--------------------------|------------------------|---|
| Advance Information      | Formative or In Design | This datasheet contains the design specifications for product development. Specifications may change in any manner without notice.  |
| Preliminary              | First Production       | This datasheet contains preliminary data, and supplementary data will be published at a later date. Fairchild Semiconductor reserves the right to make changes at any time without notice in order to improve design. |
| No Identification Needed | Full Production        | This datasheet contains final specifications. Fairchild Semiconductor reserves the right to make changes at any time without notice in order to improve design.   |
| Obsolete                 | Not In Production      | This datasheet contains specifications on a product that has been discontinued by Fairchild semiconductor. The datasheet is printed for reference information only.   |