

DUAL OPERATIONAL AMPLIFIER

■ GENERAL DESCRIPTION

The NJM4565 integrated circuit is a high-gain, wide-bandwidth, dual low noise operational amplifier capable of driving 20V peak-to-peak into 400Ω load. The NJM4565 is good characteristics compared to the NJM4560.

■ PACKAGE OUTLINE

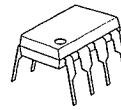

NJM4565D



NJM4565M

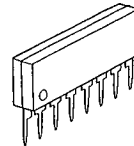

NJM4565L

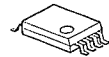

NJM4565V

■ FEATURES

- Operating Voltage (±4V ~ ±18V)
- Wide Gain Bandwidth Product (4MHz typ.)
- Slew Rate (4V/μs typ.)
- Package Outline DIP8, DMP8, SSOP8, SIP8
- Bipolar Technology

■ PIN CONFIGURATION

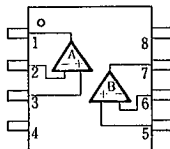

NJM4565D
NJM4565M
NJM4565V

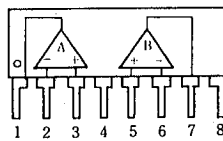

NJM4565L

PIN FUNCTION

1. A OUTPUT
2. A -INPUT
3. A+INPUT
4. V⁻
5. B+INPUT
6. B -INPUT
7. B OUTPUT
8. V⁺

4

■ EQUIVALENT CIRCUIT (1/2 Shown)

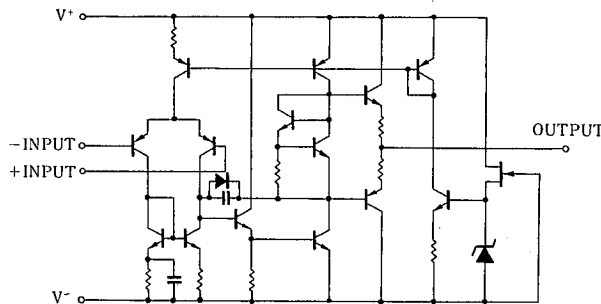

■ ABSOLUTE MAXIMUM RATINGS

(Ta=25°C)

PARAMETER	SYMBOL	RATINGS	UNIT
Supply Voltage	V ⁺ /V ⁻	±18	V
Differential Input Voltage	V _{ID}	±30	V
Input Voltage	V _{IC}	±15 (note)	V
Power Dissipation	P _D	(DIP8) 500	mW
		(DMP8) 300	mW
		(SSOP8) 250	mW
		(SIP8) 800	mW
Operating Temperature Range	T _{opr}	-20~+75	°C
Storage Temperature Range	T _{stg}	-40~+125	°C

(note) For supply voltage less than ±15V, the absolute maximum input voltage is equal to the supply voltage.

■ ELECTRICAL CHARACTERISTICS

(Ta=25°C, V⁺/V⁻=±15V)

PARAMETER	SYMBOL	TEST CONDITION	MIN.	TYP.	MAX.	UNIT
Input Offset Voltage	V _{IO}	R _S ≤ 10kΩ	—	0.5	3.0	mV
Input Offset Current	I _{IO}		—	2	50	nA
Input Bias Current	I _B		—	50	200	nA
Input Resistance	R _{IN}		0.3	5	—	MΩ
Large Signal Voltage Gain	A _V	R _L ≥ 2kΩ, V _O = ±10V	86	100	—	dB
Maximum Output Voltage Swing 1	V _{OM1}	R _L ≥ 2kΩ	±12	±14	—	V
Maximum Output Voltage Swing 2	V _{OM2}	I _O = 25mA	±10	±11.5	—	V
Input Common Mode Voltage Range	V _{ICM}		±12	±14	—	V
Common Mode Rejection Ratio	CMR	R _S ≤ 10kΩ	70	90	—	dB
Supply Voltage Rejection Ratio	SVR	R _S ≤ 10kΩ	76.5	90	—	dB
Operating Current	I _{CC}		—	4.5	7	mA
Slew Rate	SR		—	4	—	V/μs
Gain Bandwidth Product	GB		—	10	—	MHz
Equivalent Input Noise Voltage	V _{NI}	RIAA, R _S = 2.2kΩ, 30kHz LPF	—	1.2	—	μVrms

■ TYPICAL CHARACTERISTICS

Maximum Output Voltage Swing vs. Frequency

($V^+/V^- = \pm 15V$, $T_a = 25^\circ C$)

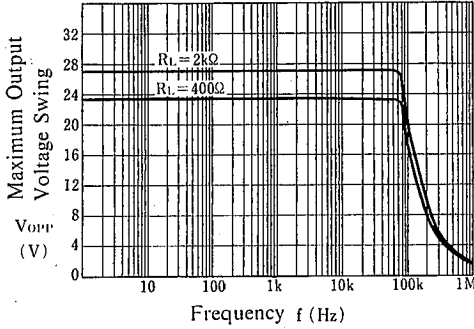

Equivalent Input Noise Voltage vs. Frequency

($V^+/V^- = \pm 15V$, $R_s = 1k\Omega$, $T_a = 25^\circ C$)

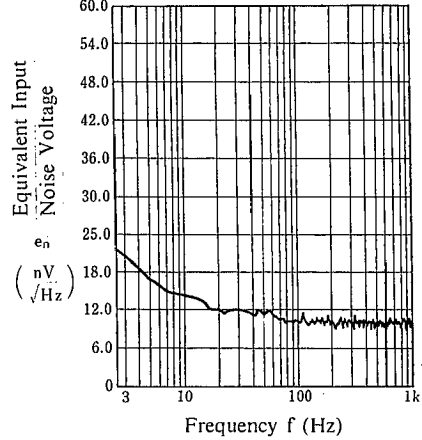

Maximum Output Voltage Swing vs. Load Resistance

($V^+/V^- = \pm 15V$, $T_a = 25^\circ C$)

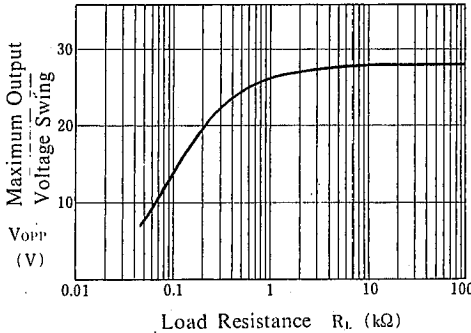

Voltage Gain Phase vs. Frequency

($V^+/V^- = \pm 15V$, $R_L = 2k\Omega$, $40dB_{amp}$, $T_a = 25^\circ C$)

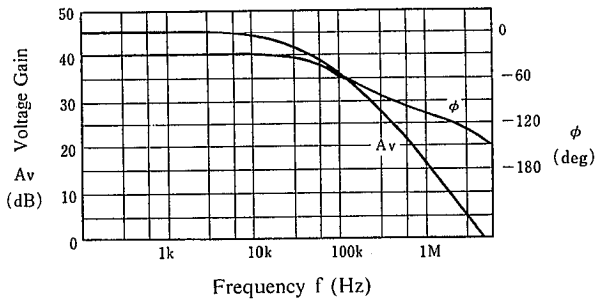

Operating Current vs. Temperature

($V^+/V^- = \pm 15V$)

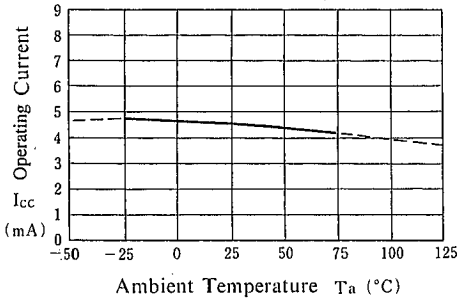

Maximum Output Voltage Swing vs. Temperature

($V^+/V^- = \pm 15V$, $R_L = 2k\Omega$)

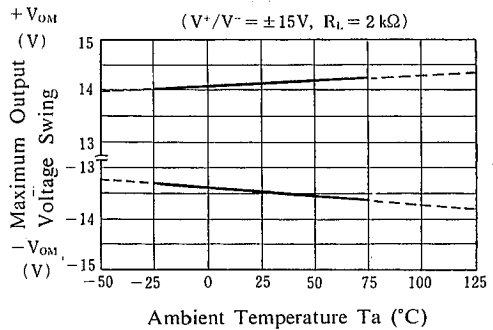

4

TYPICAL CHARACTERISTICS

Input Offset Voltage vs. Temperature

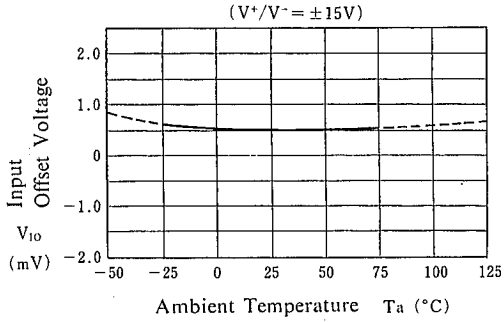

Input Bias Current vs. Temperature

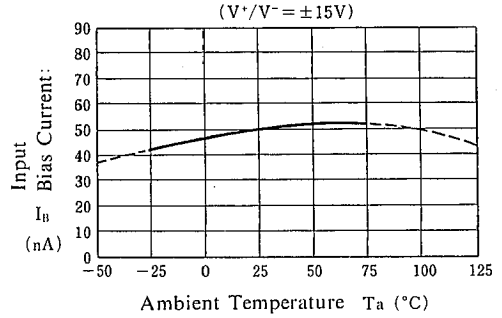

Maximum Output Voltage Swing vs. Operating Voltage

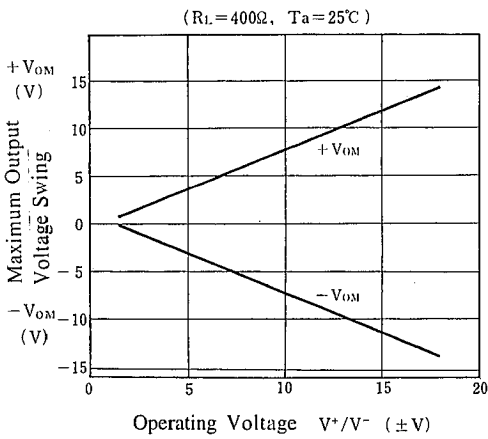

Operating Current vs. Operating Voltage

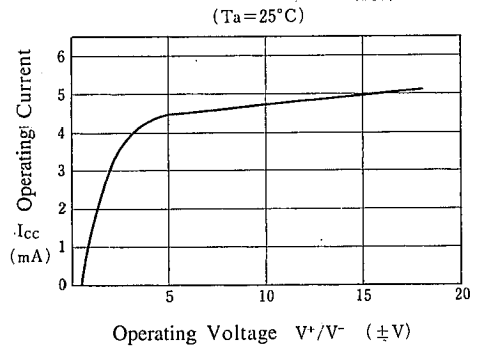

MEMO

[CAUTION]

The specifications on this databook are only given for information, without any guarantee as regards either mistakes or omissions. The application circuits in this databook are described only to show representative usages of the product and not intended for the guarantee or permission of any right including the industrial rights.