

LOW VOLTAGE C-MOS OPERATIONAL AMPLIFIER

■ GENERAL DESCRIPTION

The NJU7031, 32 and 34 are single, dual and quad C-MOS Operational Amplifiers operated on a single-power-supply, low voltage and low operating current.

The minimum operating voltage is 3V and the output stage permits output signals to swing between both of the supply rails.

The input bias current is as low as less than 1pA, consequently the very small signal around the ground level can be amplified.

Furthermore, the operating current is also as low as 1mA(typ) per circuit, therefore it can be applied especially to battery operated items.

■ PACKAGE OUTLINE

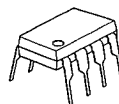

NJU7031D  
NJU7032D



NJU7031M  
NJU7032M

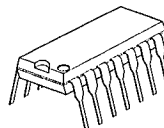

NJU7034D

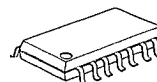

NJU7034M



NJU7031V



NJU7034V

■ FEATURES

- Single-Power-Supply
- Wide Operating Voltage ( $V_{DD}=3\sim 16V$ )
- Wide Output Swing Range ( $V_{OM}=9.98V$  typ. at  $V_{DD}=10V$ )
- Low Operating Current (1mA/circuit)
- Low Bias Current ( $I_{IB}=1pA$ )
- Internal Compensation Capacitor
- External Offset Null Adjustment (Only NJU7031)
- Package Outline
  - DIP/DMP/SSOP 8 (NJU7031)
  - DIP/DMP 8 (NJU7032)
  - DIP/DMP/SSOP 14 (NJU7034)
- C-MOS Technology

■ PIN CONFIGURATION

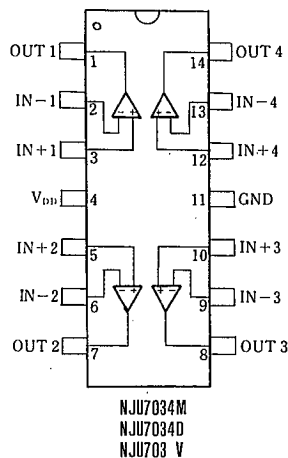
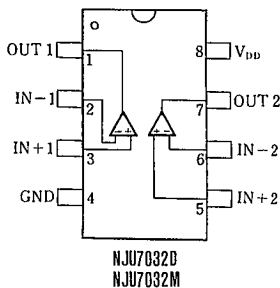
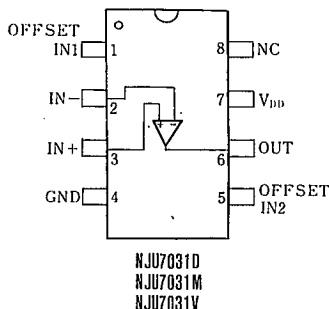

4

■ EQUIVALENT CIRCUIT

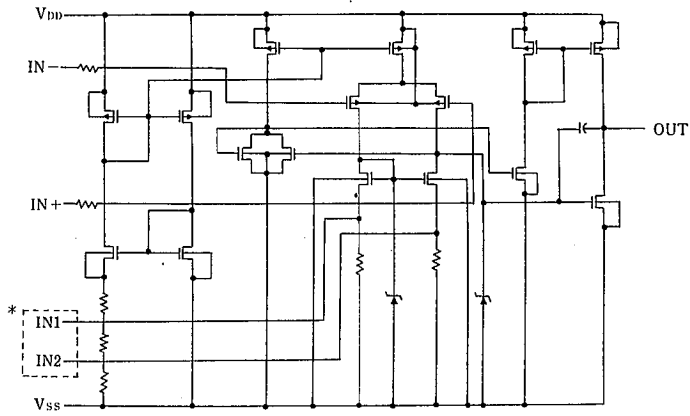

\* IN1, IN2 are only for NJU7031(NJU7032/34 don't have these terminals).

## ■ ABSOLUTE MAXIMUM RATINGS

(Ta=25°C)

PARAMETER	SYMBOL	RATINGS	UNIT
Supply Voltage	V <sub>DD</sub>	18	V
Differential Input Voltage	V <sub>ID</sub>	±18 *1	V
Common Mode Input Voltage	V <sub>IC</sub>	-0.3~18	V
Power Dissipation	P <sub>D</sub>	(DIP14) 700 (DIP8) 500 (DMP8,14) 300 (SSOP8,14) 300	mW
Operating Temperature	T <sub>opr</sub>	-20~+75	°C
Storage Temperature	T <sub>stg</sub>	-40~+125	°C

\* 1) If the supply voltage (V<sub>DD</sub>) is less than 18V, the input voltage must not over the V<sub>DD</sub> level though 18V is limit specified.

## ■ ELECTRICAL CHARACTERISTICS

(Ta=25°C, V<sub>DD</sub>=10V, R<sub>L</sub>=∞)

PARAMETER	SYMBOL	CONDITIONS	MIN.	TYP.	MAX.	UNIT
Input Offset Voltage	V <sub>IO</sub>	R <sub>S</sub> =50Ω			10	mV
Input Offset Current	I <sub>IO</sub>			1		pA
Input Bias Current	I <sub>IB</sub>			1		pA
Input Impedance	R <sub>IN</sub>			1		TΩ
Large Signal Voltage Gain	A <sub>v</sub>		80	95		dB
Input Common Mode Voltage Range	V <sub>ICM</sub>		0~9			V
Maximum Output Swing Voltage	V <sub>OM</sub>	R <sub>L</sub> =1MΩ	9.80	9.98		V
Common Mode Rejection Ratio	CMR		60	75		dB
Supply Voltage Rejection Ratio	SVR		60	75		dB
Operating Current / Circuit	I <sub>DD</sub>			1	2	mA/Cir
Slew Rate	SR			3.5		V/μs
Unity Gain Bandwidth	F <sub>t</sub>	A <sub>v</sub> =40dB C <sub>L</sub> =10pF		1.5		MHz

## ■ OFFSET ADJUSTMENT CIRCUIT (ONLY FOR NJU7031)

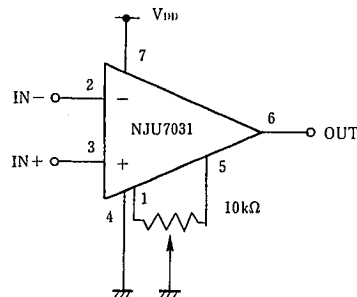

■ TYPICAL CHARACTERISTICS

Current Consumption vs. Operating Voltage

$V_{IN}=0.1V$

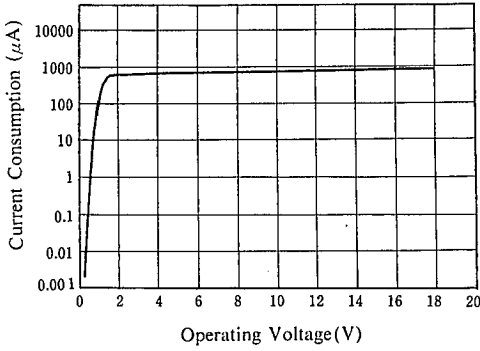

Offset Voltage vs. Operating Voltage

$V_{IN}=0.1V$

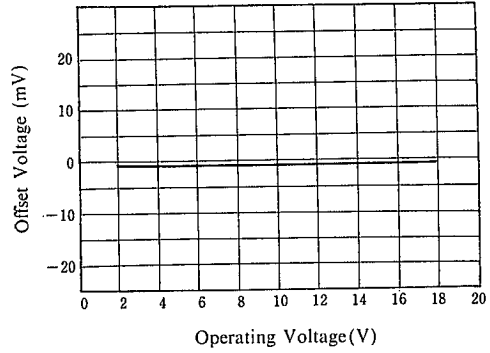

Output Current vs. Operating Voltage

$V_{IN}=0.1V$

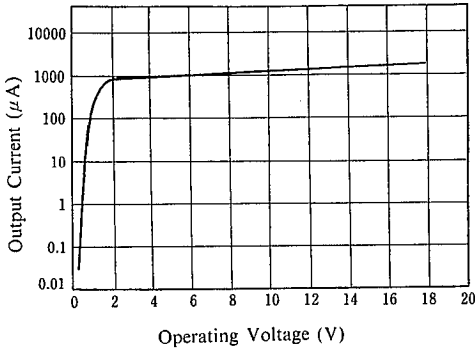

Offset Voltage vs. Input Voltage

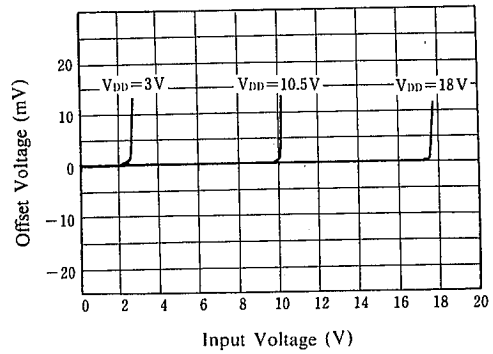

Output Voltage vs. Output Current

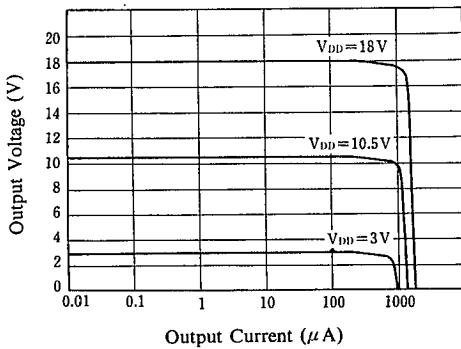

Maximum Output Swing Voltage vs. Frequency

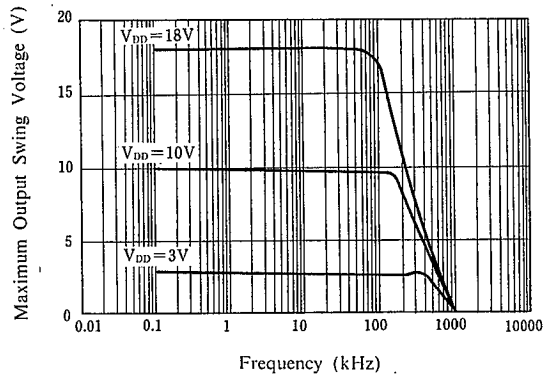

4

■ TYPICAL CHARACTERISTICS

Maximum Output Swing Voltage vs. Frequency

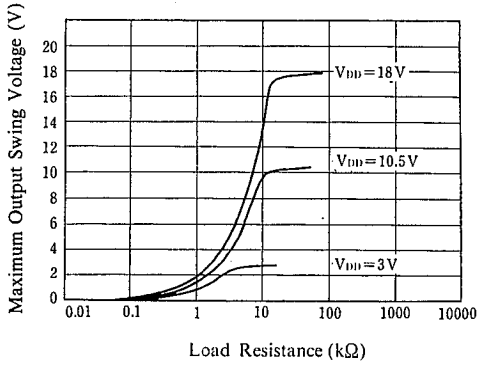

Voltage Gain · Phase vs. Frequency

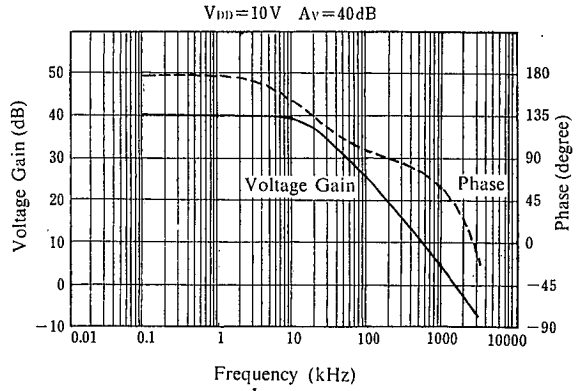

4

Equivalent Input Noise Voltage vs. Frequency

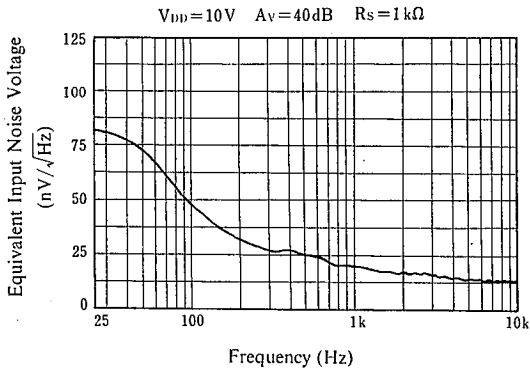

## MEMO

[CAUTION]

The specifications on this databook are only given for information, without any guarantee as regards either mistakes or omissions. The application circuits in this databook are described only to show representative usages of the product and not intended for the guarantee or permission of any right including the industrial rights.