

# DATA SHEET

**74F86**

Quad 2-input exclusive-OR gate

Product specification

1990 Feb 09

IC15 Data Handbook

# Quad 2-input Exclusive-OR gate

# 74F86

## FEATURE

- Industrial temperature range available (-40°C to +85°C)

TYPE	TYPICAL PROPAGATION DELAY	TYPICAL SUPPLY CURRENT (TOTAL)
74F86	4.3ns	16.5mA

## PIN CONFIGURATION

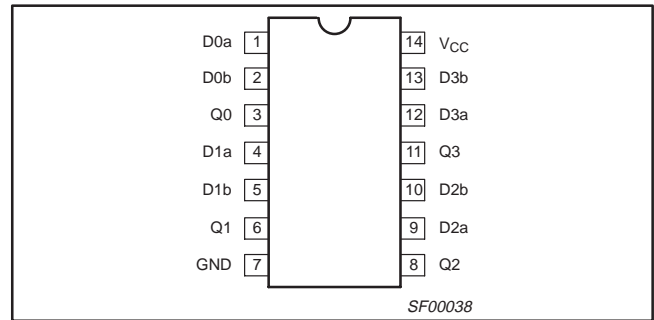

## ORDERING INFORMATION

DESCRIPTION	ORDER CODE		PKG DWG #
	COMMERCIAL RANGE V <sub>CC</sub> = 5V ±10%, T <sub>amb</sub> = 0°C to +70°C	INDUSTRIAL RANGE V <sub>CC</sub> = 5V ±10%, T <sub>amb</sub> = -40°C to +85°C	
14-pin plastic DIP	N74F86N	I74F86N	SOT27-1
14-pin plastic SO	N74F86D	I74F86D	SOT108-1

## INPUT AND OUTPUT LOADING AND FAN-OUT TABLE

PINS	DESCRIPTION	74F (U.L.) HIGH/LOW	LOAD VALUE HIGH/LOW
Dna, Dnb	Data inputs	1.0/1.0	20µA/0.6mA
Qn	Data output	50/33	1.0mA/20mA

### NOTE:

- One (1.0) FAST unit load is defined as: 20µA in the High state and 0.6mA in the Low state.

## LOGIC DIAGRAM

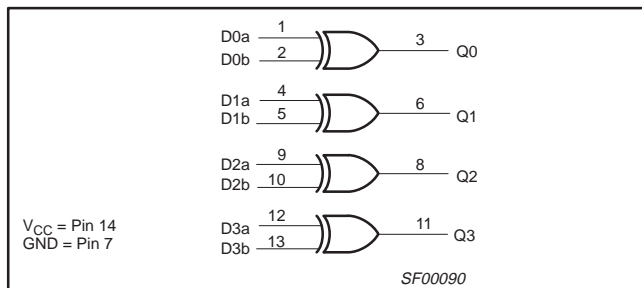

## FUNCTION TABLE

INPUTS		OUTPUT
Dna	Dnb	Qn
L	L	L
L	H	H
H	L	H
H	H	L

### NOTES:

- H = High voltage level
- L = Low voltage level

## LOGIC SYMBOL

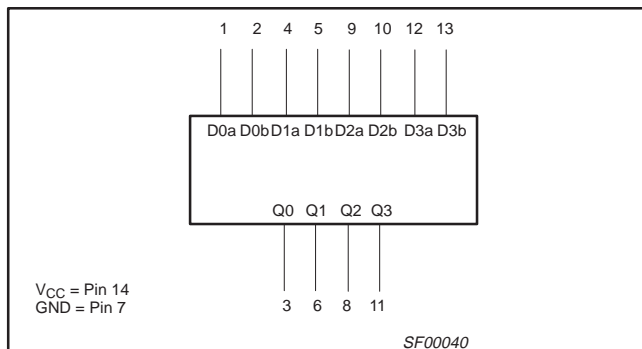

## IEC/IEEE SYMBOL

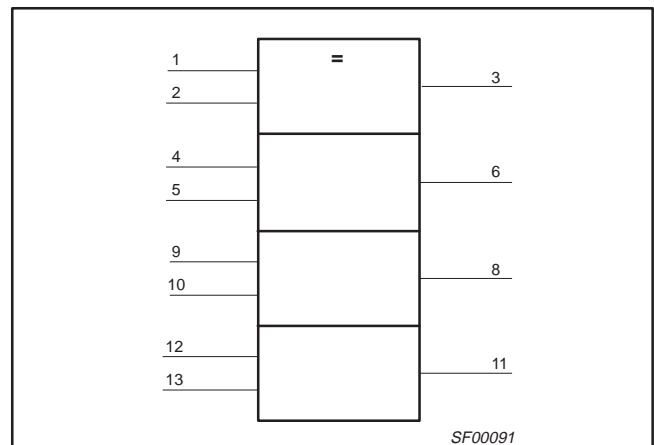

## Quad 2-input Exclusive-OR gate

74F86

**ABSOLUTE MAXIMUM RATINGS**

(Operation beyond the limits set forth in this table may impair the useful life of the device.  
Unless otherwise noted these limits are over the operating free-air temperature range.)

SYMBOL	PARAMETER		RATING	UNIT	
$V_{CC}$	Supply voltage		-0.5 to +7.0	V	
$V_{IN}$	Input voltage		-0.5 to +7.0	V	
$I_{IN}$	Input current		-30 to +5	mA	
$V_{OUT}$	Voltage applied to output in High output state		-0.5 to $V_{CC}$	V	
$I_{OUT}$	Current applied to output in Low output state		40	mA	
$T_{amb}$	Operating free-air temperature range		Commercial range	0 to +70	°C
			Industrial range	-40 to +85	°C
$T_{stg}$	Storage temperature range		-65 to +150	°C	

**RECOMMENDED OPERATING CONDITIONS**

SYMBOL	PARAMETER	LIMITS			UNIT	
		MIN	NOM	MAX		
$V_{CC}$	Supply voltage	4.5	5.0	5.5	V	
$V_{IH}$	High-level input voltage	2.0			V	
$V_{IL}$	Low-level input voltage			0.8	V	
$I_{IK}$	Input clamp current			-18	mA	
$I_{OH}$	High-level output current			-1	mA	
$I_{OL}$	Low-level output current			20	mA	
$T_{amb}$	Operating free-air temperature range		Commercial range	0	+70	°C
			Industrial range	-40	+85	°C

**DC ELECTRICAL CHARACTERISTICS**

(Over recommended operating free-air temperature range unless otherwise noted.)

SYMBOL	PARAMETER	TEST CONDITIONS <sup>1</sup>	LIMITS			UNIT	
			MIN	TYP <sup>2</sup>	MAX		
$V_{OH}$	High-level output voltage	$V_{CC} = \text{MIN}, V_{IL} = \text{MAX}$	$\pm 10\%V_{CC}$	2.5		V	
		$V_{IH} = \text{MIN}, I_{OH} = \text{MAX}$	$\pm 5\%V_{CC}$	2.7	3.4	V	
$V_{OL}$	Low-level output voltage	$V_{CC} = \text{MIN}, V_{IL} = \text{MAX}$	$\pm 10\%V_{CC}$		0.30	0.50	V
		$V_{IH} = \text{MIN}, I_{OL} = \text{MAX}$	$\pm 5\%V_{CC}$		0.30	0.50	V
$V_{IK}$	Input clamp voltage	$V_{CC} = \text{MIN}, I_I = I_{IK}$		-0.73	-1.2	V	
$I_I$	Input current at maximum input voltage	$V_{CC} = \text{MAX}, V_I = 7.0V$			100	$\mu A$	
$I_{IH}$	High-level input current	$V_{CC} = \text{MAX}, V_I = 2.7V$			20	$\mu A$	
$I_{IL}$	Low-level input current	$V_{CC} = \text{MAX}, V_I = 0.5V$			-0.6	mA	
$I_{OS}$	Short-circuit output current <sup>3</sup>	$V_{CC} = \text{MAX}$		-60	-150	mA	
$I_{CC}$	Supply current (total)	$I_{CCH}$ $V_{CC} = \text{MAX}$	D0a = GND, D0b = 4.5V		15	23	mA
		$I_{CCL}$ $V_{CC} = \text{MAX}$	$V_{IN} = 4.5V$		18	28	mA

**NOTES:**

- For conditions shown as MIN or MAX, use the appropriate value specified under recommended operating conditions for the applicable type.
- All typical values are at  $V_{CC} = 5V, T_{amb} = 25^\circ C$ .
- Not more than one output should be shorted at a time. For testing  $I_{OS}$ , the use of high-speed test apparatus and/or sample-and-hold techniques are preferable in order to minimize internal heating and more accurately reflect operational values. Otherwise, prolonged shorting of a High output may raise the chip temperature well above normal and thereby cause invalid readings in other parameter tests. In any sequence of parameter tests,  $I_{OS}$  tests should be performed last.

# Quad 2-input Exclusive-OR gate

74F86

## AC ELECTRICAL CHARACTERISTICS

SYMBOL	PARAMETER	TEST CONDITION	LIMITS						UNIT	
			$V_{CC} = +5.0V$ $T_{amb} = +25^{\circ}C$ $C_L = 50pF$ $R_L = 500\Omega$			$V_{CC} = +5.0V \pm 10\%$ $T_{amb} = 0^{\circ}C \text{ to } +70^{\circ}C$ $C_L = 50pF$ $R_L = 500\Omega$		$V_{CC} = +5.0V \pm 10\%$ $T_{amb} = -40^{\circ}C \text{ to } +85^{\circ}C$ $C_L = 50pF$ $R_L = 500\Omega$		
			MIN	TYP	MAX	MIN	MAX	MIN		MAX
$t_{PLH}$ $t_{PHL}$	Propagation delay Dna or Dnb to Qn (other input Low)	Waveform 1	3.0	4.0	5.5	3.0	6.5	3.0	7.0	ns
$t_{PLH}$ $t_{PHL}$	Propagation delay Dna or Dnb to Qn (other input High)	Waveform 2	3.5	5.3	7.0	3.5	8.0	3.5	10.0	ns

## AC WAVEFORMS

For all waveforms,  $V_M = 1.5V$ .

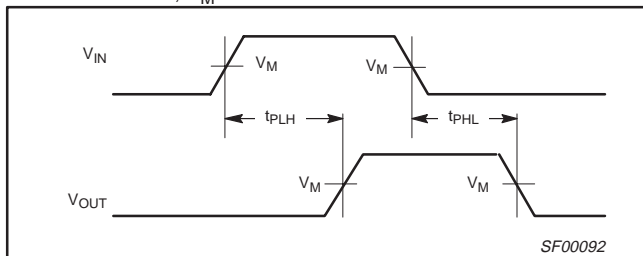

Waveform 1. Propagation Delay for Non-Inverting Outputs

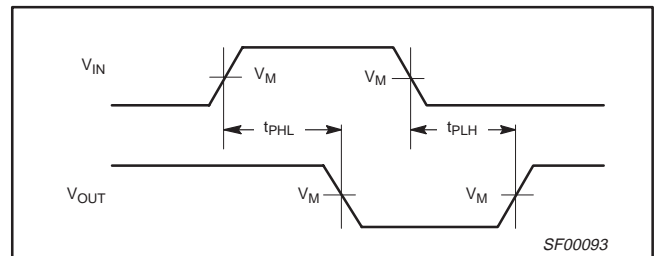

Waveform 2. Propagation Delay for Inverting Outputs

## TEST CIRCUIT AND WAVEFORMS

**Test Circuit for Totem-Pole Outputs**

**Input Pulse Definition**

**DEFINITIONS:**  
 $R_L$  = Load resistor; see AC ELECTRICAL CHARACTERISTICS for value.  
 $C_L$  = Load capacitance includes jig and probe capacitance; see AC ELECTRICAL CHARACTERISTICS for value.  
 $R_T$  = Termination resistance should be equal to  $Z_{OUT}$  of pulse generators.

family	INPUT PULSE REQUIREMENTS					
	amplitude	$V_M$	rep. rate	$t_w$	$t_{TLH}$	$t_{THL}$
74F	3.0V	1.5V	1MHz	500ns	2.5ns	2.5ns

SF00006

# Quad 2-input exclusive-OR gate

74F86

DIP14: plastic dual in-line package; 14 leads (300 mil)

SOT27-1



**DIMENSIONS (inch dimensions are derived from the original mm dimensions)**

UNIT	A max.	A <sub>1</sub> min.	A <sub>2</sub> max.	b	b <sub>1</sub>	c	D <sup>(1)</sup>	E <sup>(1)</sup>	e	e <sub>1</sub>	L	M <sub>E</sub>	M <sub>H</sub>	w	Z <sup>(1)</sup> max.
mm	4.2	0.51	3.2	1.73 1.13	0.53 0.38	0.36 0.23	19.50 18.55	6.48 6.20	2.54	7.62	3.60 3.05	8.25 7.80	10.0 8.3	0.254	2.2
inches	0.17	0.020	0.13	0.068 0.044	0.021 0.015	0.014 0.009	0.77 0.73	0.26 0.24	0.10	0.30	0.14 0.12	0.32 0.31	0.39 0.33	0.01	0.087

**Note**

1. Plastic or metal protrusions of 0.25 mm maximum per side are not included.

OUTLINE VERSION	REFERENCES			EUROPEAN PROJECTION	ISSUE DATE
	IEC	JEDEC	EIAJ		
SOT27-1	050G04	MO-001AA			92-11-17 95-03-11

# Quad 2-input exclusive-OR gate

74F86

SO14: plastic small outline package; 14 leads; body width 3.9 mm

SOT108-1



**DIMENSIONS (inch dimensions are derived from the original mm dimensions)**

UNIT	A max.	A <sub>1</sub>	A <sub>2</sub>	A <sub>3</sub>	b <sub>p</sub>	c	D <sup>(1)</sup>	E <sup>(1)</sup>	e	H <sub>E</sub>	L	L <sub>p</sub>	Q	v	w	y	Z <sup>(1)</sup>	θ
mm	1.75	0.25 0.10	1.45 1.25	0.25	0.49 0.36	0.25 0.19	8.75 8.55	4.0 3.8	1.27	6.2 5.8	1.05	1.0 0.4	0.7 0.6	0.25	0.25	0.1	0.7 0.3	8° 0°
inches	0.069	0.010 0.004	0.057 0.049	0.01	0.019 0.014	0.0100 0.0075	0.35 0.34	0.16 0.15	0.050	0.244 0.228	0.041	0.039 0.016	0.028 0.024	0.01	0.01	0.004	0.028 0.012	

**Note**

1. Plastic or metal protrusions of 0.15 mm maximum per side are not included.

OUTLINE VERSION	REFERENCES				EUROPEAN PROJECTION	ISSUE DATE
	IEC	JEDEC	EIAJ			
SOT108-1	076E06S	MS-012AB				95-01-23 97-05-22

---

Quad 2-input exclusive-OR gate

74F86

---

**NOTES**

## Quad 2-input exclusive-OR gate

74F86

## Data sheet status

Data sheet status	Product status	Definition [1]
Objective specification	Development	This data sheet contains the design target or goal specifications for product development. Specification may change in any manner without notice.
Preliminary specification	Qualification	This data sheet contains preliminary data, and supplementary data will be published at a later date. Philips Semiconductors reserves the right to make changes at any time without notice in order to improve design and supply the best possible product.
Product specification	Production	This data sheet contains final specifications. Philips Semiconductors reserves the right to make changes at any time without notice in order to improve design and supply the best possible product.

[1] Please consult the most recently issued datasheet before initiating or completing a design.

## Definitions

**Short-form specification** — The data in a short-form specification is extracted from a full data sheet with the same type number and title. For detailed information see the relevant data sheet or data handbook.

**Limiting values definition** — Limiting values given are in accordance with the Absolute Maximum Rating System (IEC 134). Stress above one or more of the limiting values may cause permanent damage to the device. These are stress ratings only and operation of the device at these or at any other conditions above those given in the Characteristics sections of the specification is not implied. Exposure to limiting values for extended periods may affect device reliability.

**Application information** — Applications that are described herein for any of these products are for illustrative purposes only. Philips Semiconductors make no representation or warranty that such applications will be suitable for the specified use without further testing or modification.

## Disclaimers

**Life support** — These products are not designed for use in life support appliances, devices or systems where malfunction of these products can reasonably be expected to result in personal injury. Philips Semiconductors customers using or selling these products for use in such applications do so at their own risk and agree to fully indemnify Philips Semiconductors for any damages resulting from such application.

**Right to make changes** — Philips Semiconductors reserves the right to make changes, without notice, in the products, including circuits, standard cells, and/or software, described or contained herein in order to improve design and/or performance. Philips Semiconductors assumes no responsibility or liability for the use of any of these products, conveys no license or title under any patent, copyright, or mask work right to these products, and makes no representations or warranties that these products are free from patent, copyright, or mask work right infringement, unless otherwise specified.

Philips Semiconductors  
811 East Arques Avenue  
P.O. Box 3409  
Sunnyvale, California 94088-3409  
Telephone 800-234-7381

© Copyright Philips Electronics North America Corporation 1998  
All rights reserved. Printed in U.S.A.

print code

Date of release: 10-98

Document order number:

9397-750-05068

*Let's make things better.*