

ZN414Z, ZN415E, ZN416E

AM RADIO RECEIVERS

FEATURES

- Single cell operation (1.1 to 1.6 volt operating range)
- Low current consumption
- 150kHz to 3MHz frequency range (i.e. full coverage of medium and long wavebands)
- Easy to assemble, no alignment necessary
- Simple and effective AGC action
- Will drive crystal earphone direct (ZN414Z)
- Will drive headphones direct (ZN415E and ZN416E)
- Excellent audio quality
- Typical power gain of 72dB (ZN414Z)
- Minimum of external components required

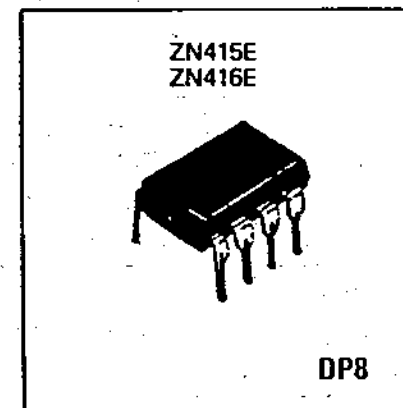
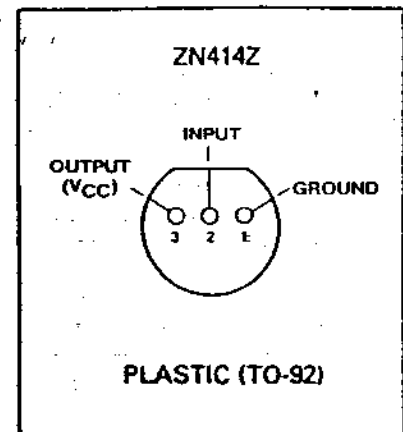

GENERAL DESCRIPTION

The ZN414Z is a 10 transistor tuned radio frequency (TRF) circuit packaged in a 3-pin TO-92 plastic package for simplicity and space economy.

The circuit provides a complete R.F. amplifier, detector and AGC circuit which requires only six external components to give a high quality A.M. tuner. Effective AGC action is available and is simply adjusted by selecting one external resistor value. Excellent audio quality can be achieved, and current consumption is extremely low. No setting-up or alignment is required and the circuit is completely stable in use.

The ZN415E retains all the features of the ZN414Z but also incorporates a buffer stage giving sufficient output to drive headphones directly from the 8 pin DIL.

Similarly the ZN416E is a buffered output version of the ZN414Z giving typically 120mV (r.m.s.) output into a 64Ω load. The same package and pinning is used for the ZN416E as the ZN415E.

EVICe SPECIFICATIONS $T_{amb} = 25^{\circ}C$, $V_{CC} = 1.4V$. Parameters apply to all types unless otherwise stated.

Parameter	Min.	Typ	Max.	Units
Supply voltage, V_{CC}	1.1	1.3	1.6	volts
Supply current, I_S with 64 Ω headphones		ZN414Z 0.3 ZN415E 2.3 ZN416E 4	0.5 3 5	mA
Input frequency range	0.15	-	3.0	MHz
Input resistance	-	4.0	-	M Ω
Threshold sensitivity (Dependant on Q of coil)		50		μV
Selectivity	-	4.0	-	kHz
Total harmonic distortion	-	3.0	-	%
AGC range	-	20	-	dB
Power gain (ZN414Z)		72		dB
Voltage gain of output stage		ZN415E 6 ZN416E 18	-	dB
Output voltage into 64 Ω load before clipping		ZN414Z 60 ZN415E 120 ZN416E 340	-	mVpp
Upper cut-off frequency of output stage, No capacitor, (ZN415E and ZN416E)	20	-	-	kHz
With 0.01 μF between pin 7 and 0V (ZN415E)	-	6	-	kHz
With 0.01 μF between pin 7 and 0V (ZN416E)	-	10	-	kHz
Lower cut-off frequency of output stage 0.1 μF between pins 2 and 3 for ZN415E 0.47 μF between pins 2 and 3 for ZN416E		50	-	Hz
Quiescent output voltage		ZN414Z 40 ZN415E 80 ZN416E 200	-	mV
Operating temperature range	0	-	70	$^{\circ}C$
Maximum storage temperature	-65	-	125	$^{\circ}C$

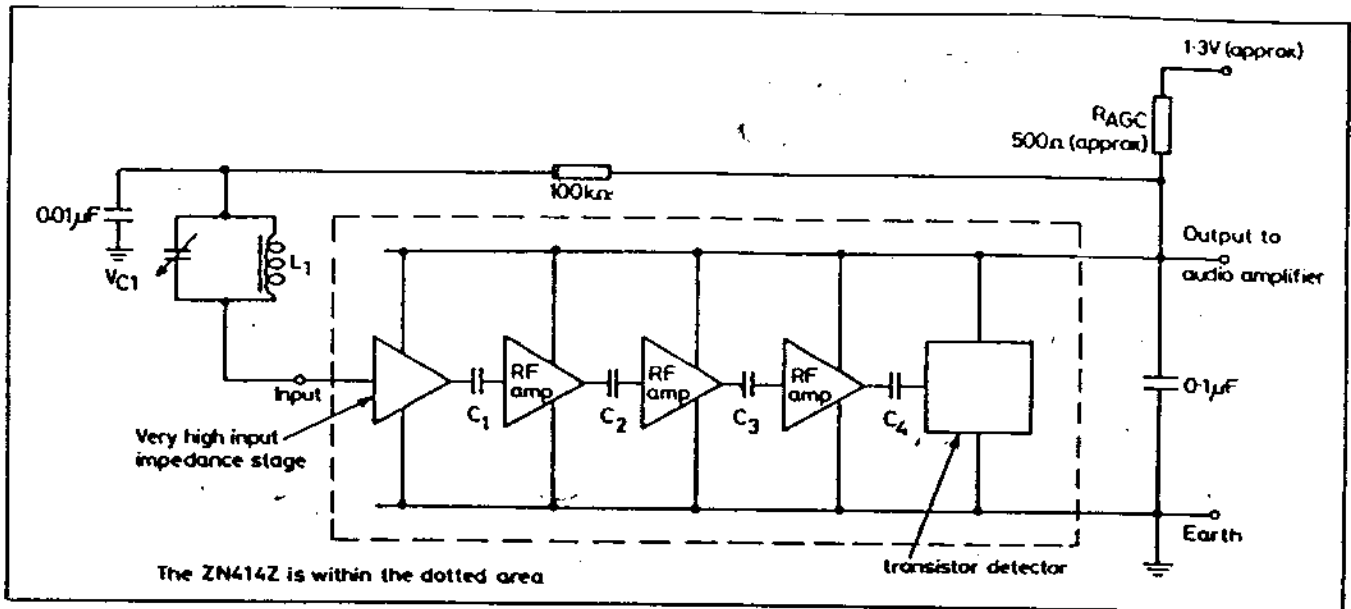

ZN414Z System Diagram

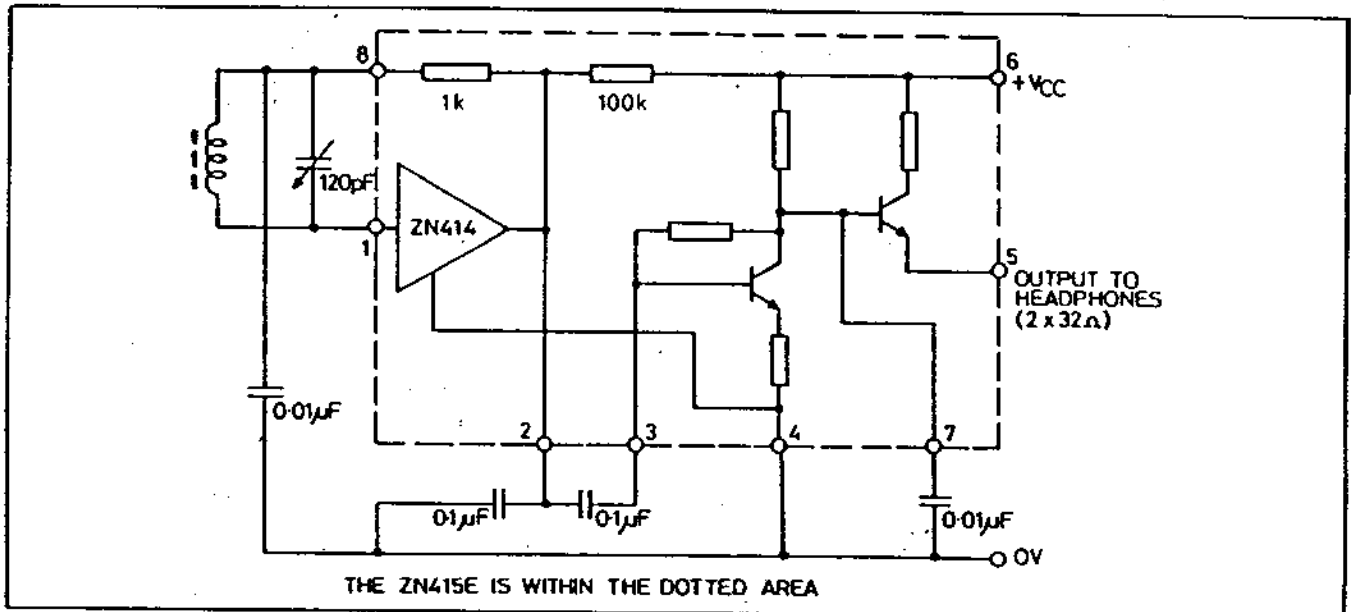

ZN415E System Diagram

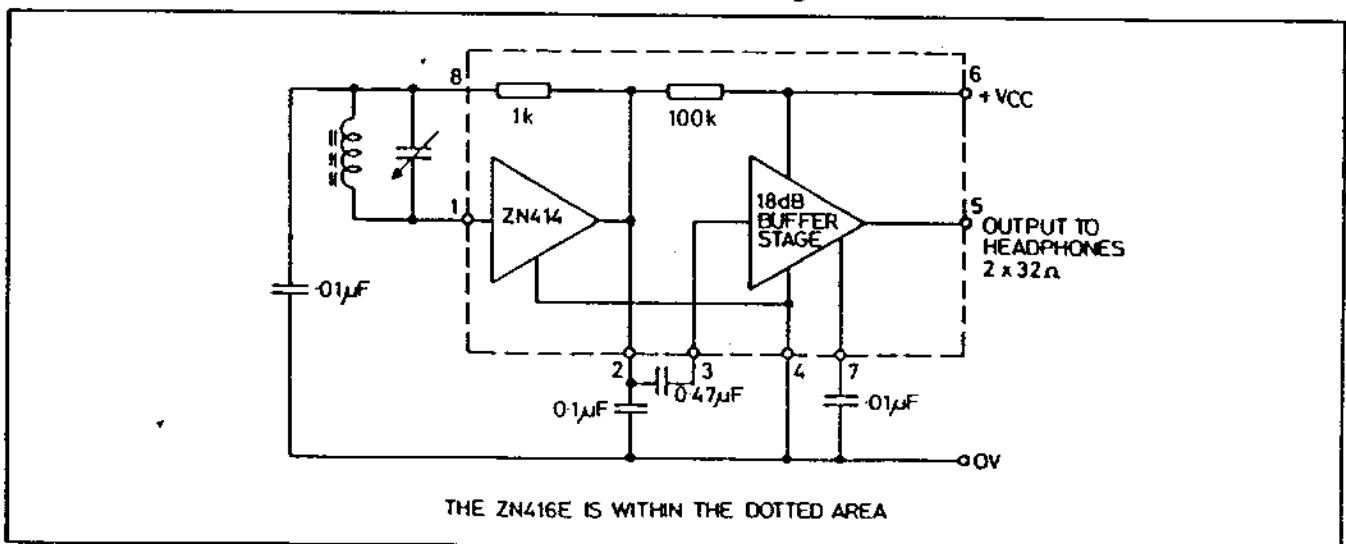

ZN416E System Diagram

ZN414Z CHARACTERISTICS – All measurements performed with 30% modulation. $F_M = 400\text{Hz}$

Gain and AGC characteristics

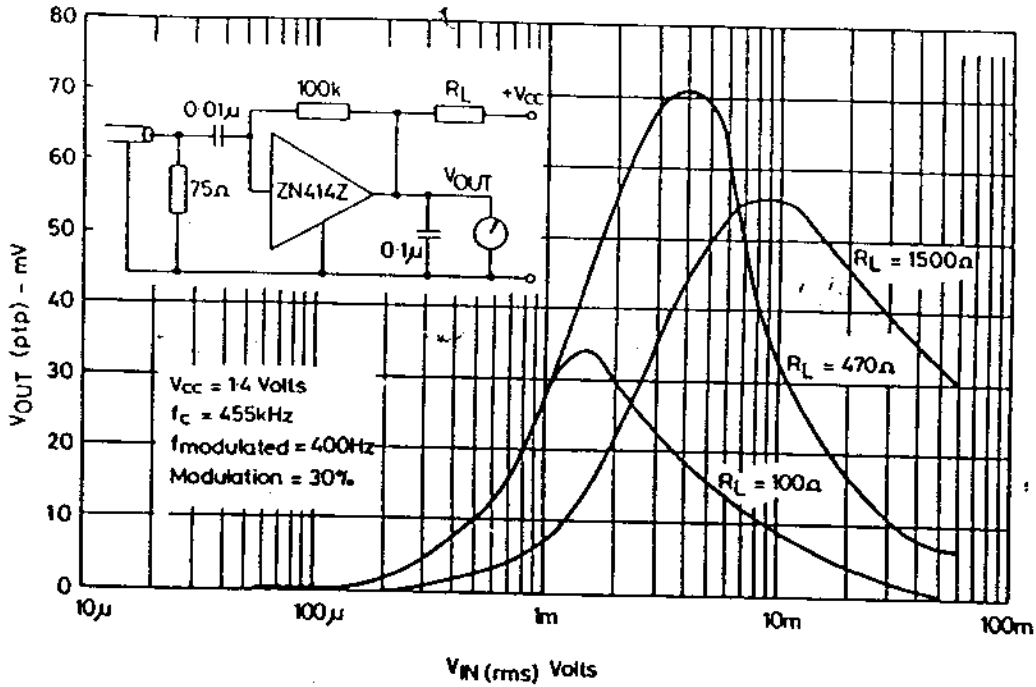

See operating notes for explanation of AGC action.

Frequency response of the ZN414Z

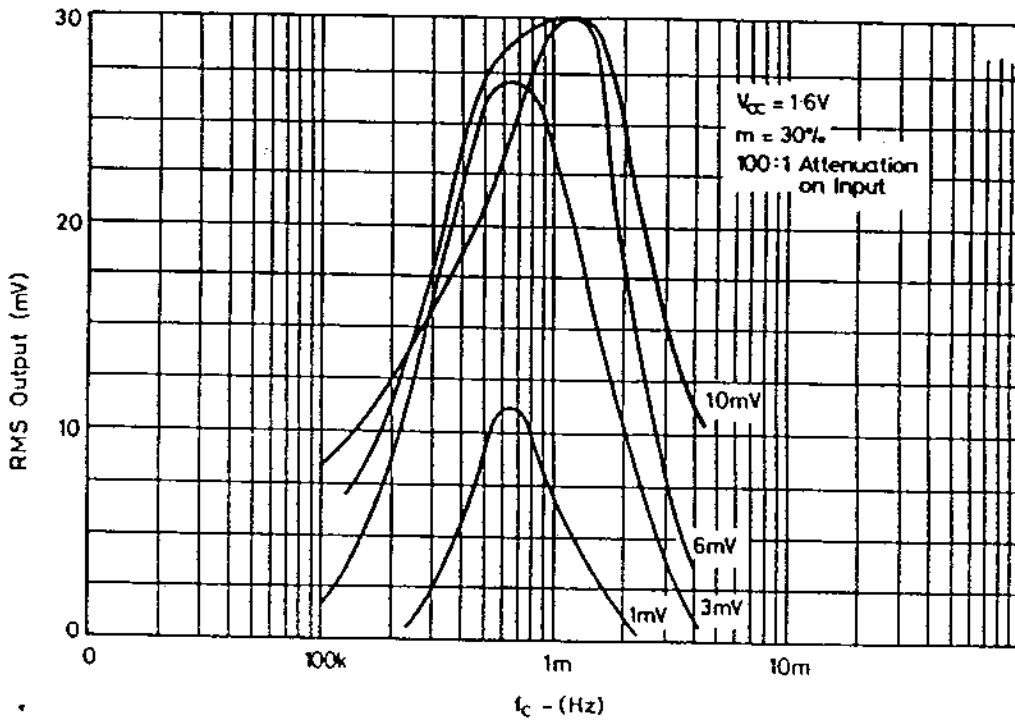

Note that this graph represents the chip response, and not the receiver bandwidth.

ZN414Z CHARACTERISTICS - (Continued)

Gain variation with supply volts.

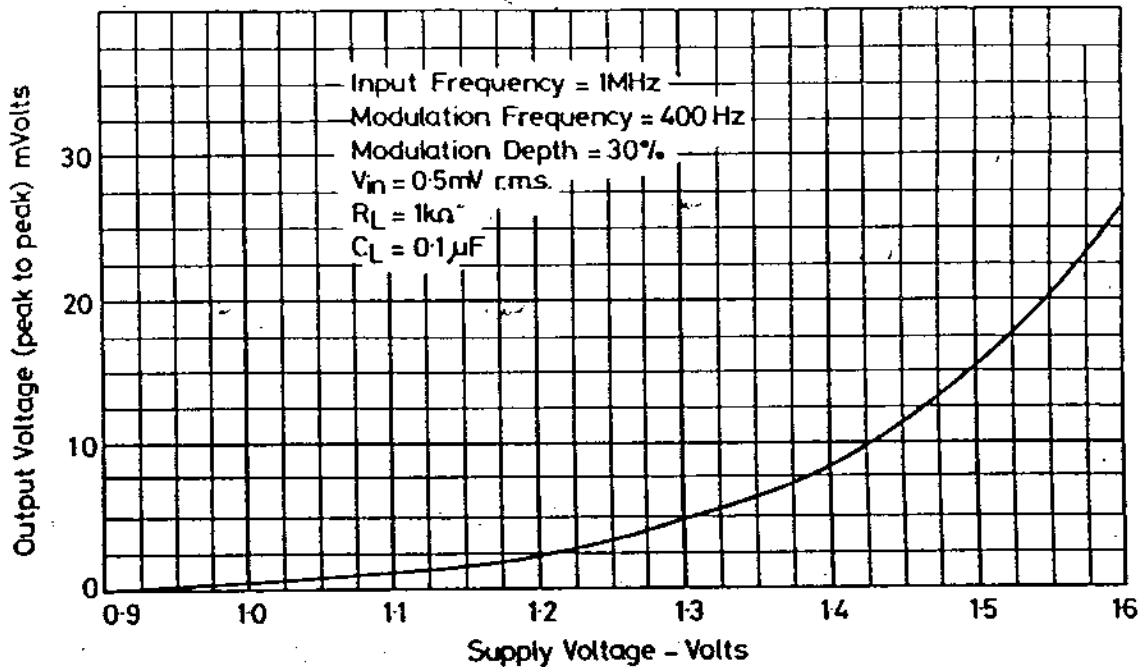

D.C. level at output

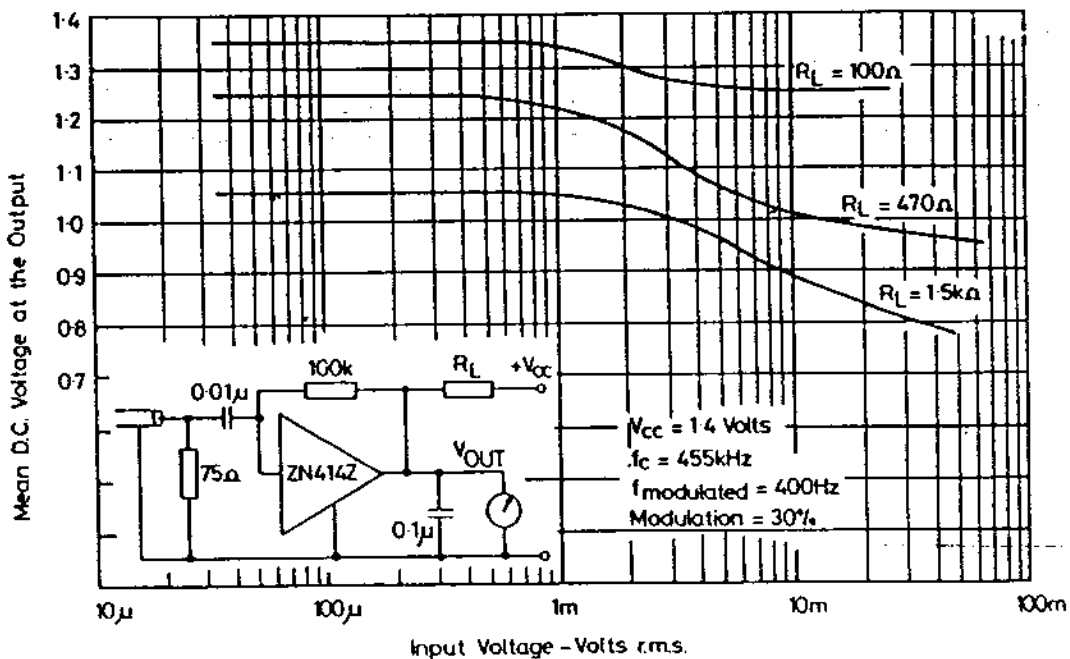

LAYOUT REQUIREMENTS

As with any high gain R.F. device, certain basic layout rules must be adhered to if stable and reliable operation is to be obtained. These are listed below:

1. The output decoupling capacitor should be soldered as near as possible to the output and earth leads of the ZN414Z. Furthermore, its value together with the AGC resistor (R_{AGC}) should be calculated at $\approx 4\text{kHz}$, i.e.:

$$C \text{ (farads)} = \frac{1}{2\pi \cdot R_{AGC} \cdot 4 \cdot 10^3}$$

2. All leads should be kept as short as possible, especially those in close proximity to the ZN414Z.
3. The tuning assembly should be some distance from the battery, loudspeaker and their associated leads.
4. The 'earthy' side of the tuning capacitor should be connected to the junction of the $100\text{k}\Omega$ resistor and the $0.01\mu\text{F}$ capacitor.

OPERATING NOTES

(a) Selectivity

To obtain good selectivity, essential with any T.R.F. device, the ZN414Z must be fed from an efficient, high 'Q' coil and capacitor tuning network. With suitable components the selectivity is comparable to superhet designs, except that a very strong signal in proximity to the receiver may swamp the device unless the ferrite rod aerial is rotated to "null-out" the strong signal.

Two other factors affect the apparent selectivity of the device. Firstly, the gain of the ZN414Z is voltage sensitive (see previous page) so that, in strong signal areas, less supply voltage will be needed to obtain correct AGC action. Incorrect adjustment of the AGC causes a strong station to occupy a much wider bandwidth than necessary and in extreme cases can cause the RF stages to saturate before the AGC can limit RF gain. This gives the effect of swamping together with reduced AF output. All the above factors have to be considered if optimum performance is to be obtained.

(b) Ferrite aerial size

Because of the gain variation available by altering supply voltage, the size of the ferrite rod is relatively unimportant. However, the ratio of aerial rod length to diameter should ideally be large to give the receiver better directional properties. Successful receivers have been constructed with ferrite rod aeriels of 4cm (1.5") and up to 20cm (8").

DRIVE CIRCUITS

Three types of drive circuit are shown, each has been used successfully. The choice is largely an economic one, but circuit 3 is recommended wherever possible, having several advantages over the other circuits. Values for 9V supplies are shown, simple calculations will give values for other supplies.

1. Resistive Divider (ZN414Z)

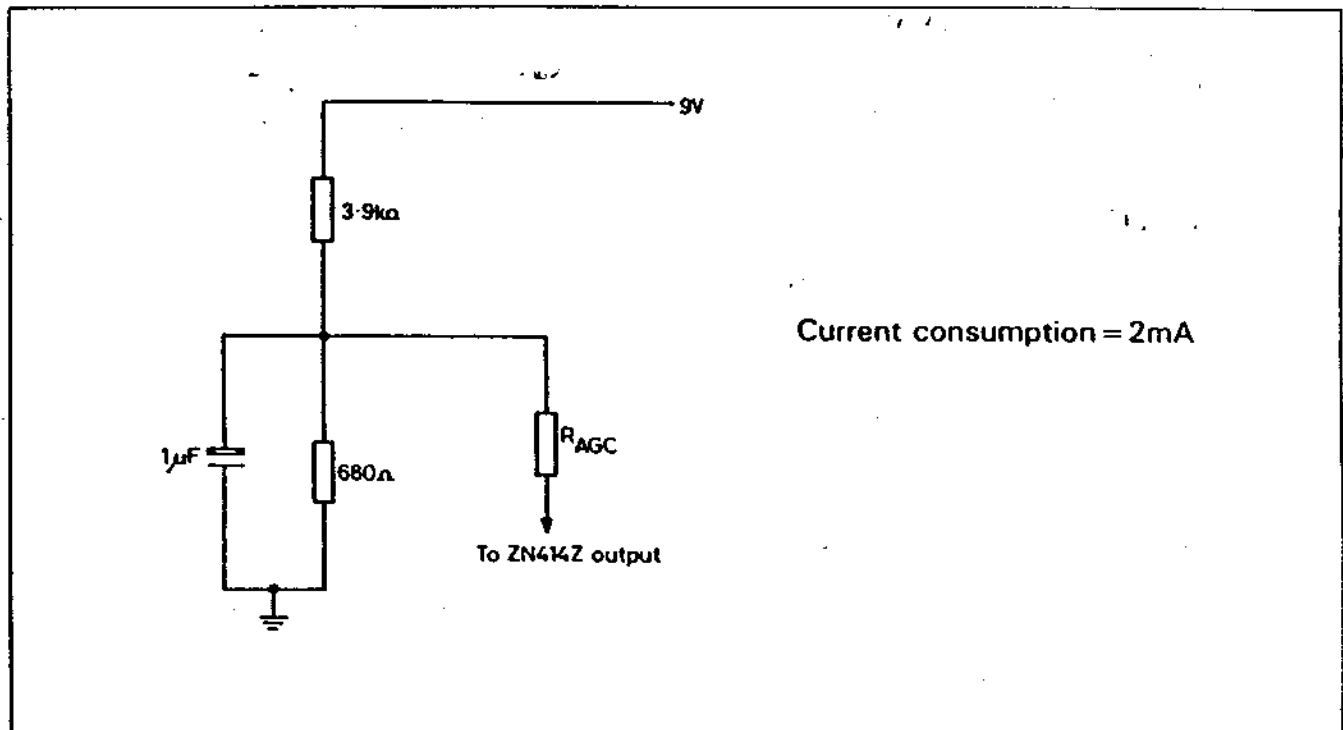

Note: Replacing the 680Ω resistor with a 500Ω resistor and a 250Ω preset, sensitivity may be adjusted and will enable optimum reception to be realised under most conditions.

2. Diode Drive (ZN414Z)

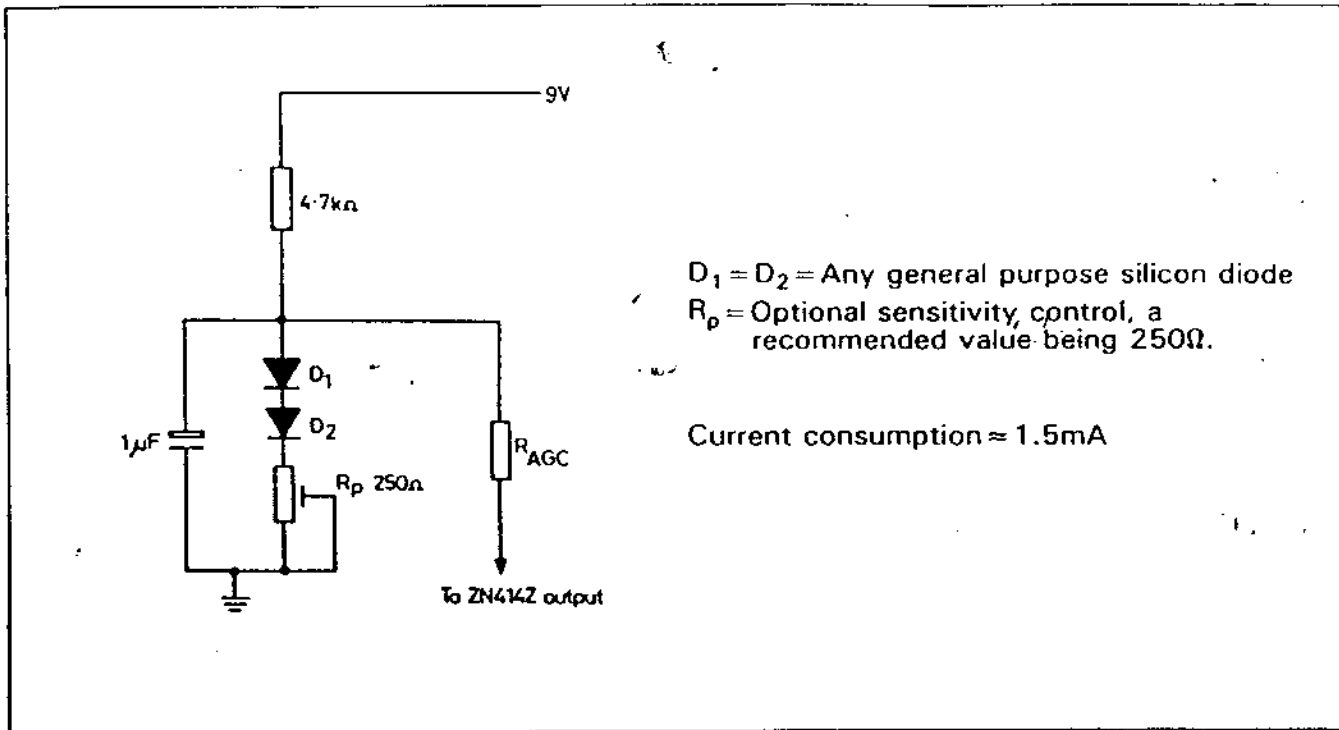

3. Transistor Drive (ZN414Z and ZN415E)

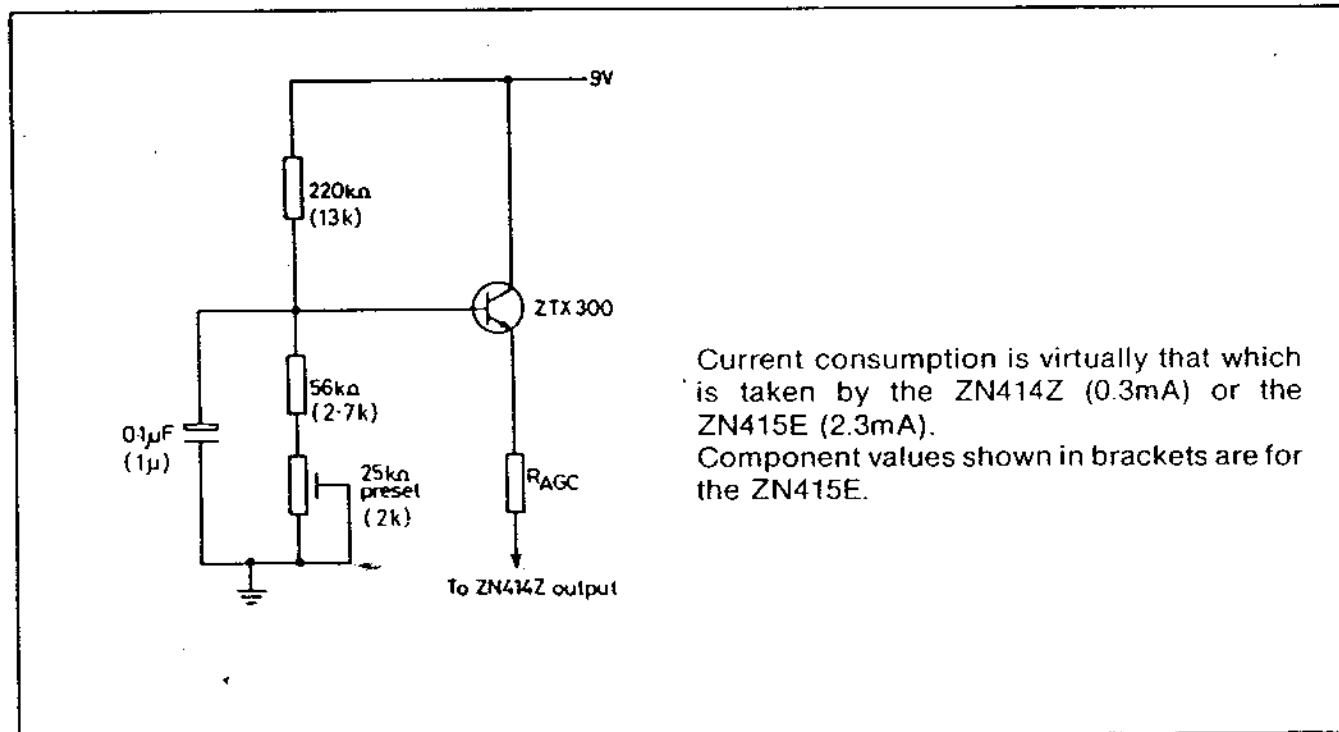

(b)i

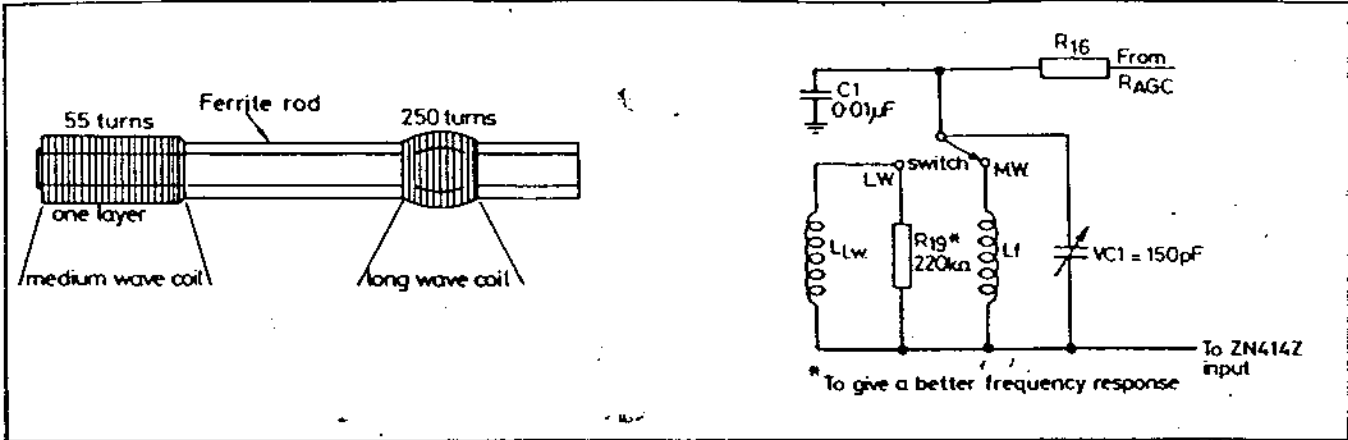

Coil winding details and waveband selection

(c) Use in model control receiver

The circuit below shows a ZN414Z used as an I.F. amplifier for a 27MHz superhet receiver.

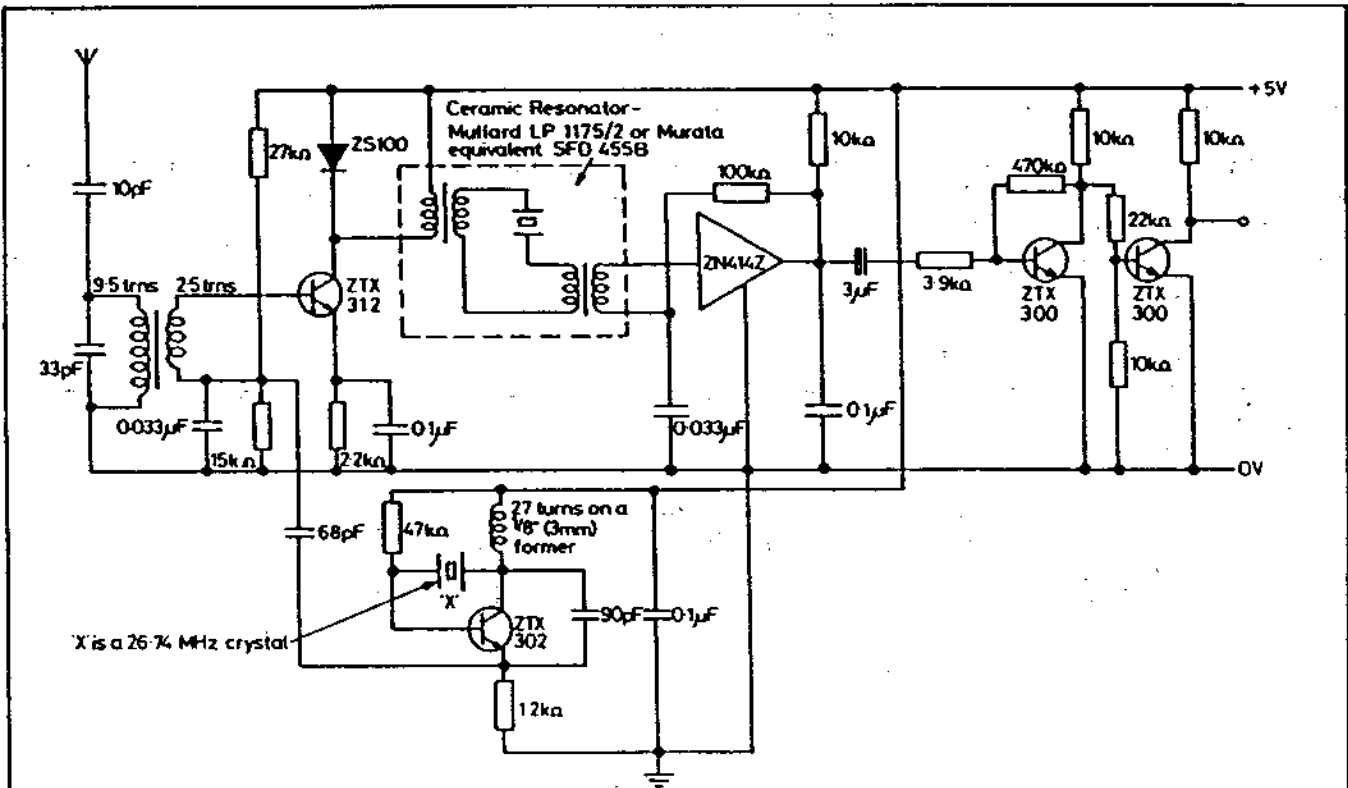

Performance Details:

Sensitivity = $2.5\mu\text{V}$ for a 5V p.t.p. output measured at $f_c = 27.21\text{MHz}$, 100% modulated with 100Hz square wave.

Selectivity: $\pm 5\text{kHz}$ for $< 100\text{mV}$ p.t.p. output.

Input Signal Range: $2.5\mu\text{V}$ to 25mV (i.e. 80dB)

Supply Current: $\approx 4.5\text{mA}$.

(d) Broadcast band superhet using ZN414Z

The ZN414Z coupled with the modern ceramic resonators offers a very good I.F. amplifier at modest cost, whilst maintaining simplicity and minimal alignment requirements. A typical circuit is shown below:

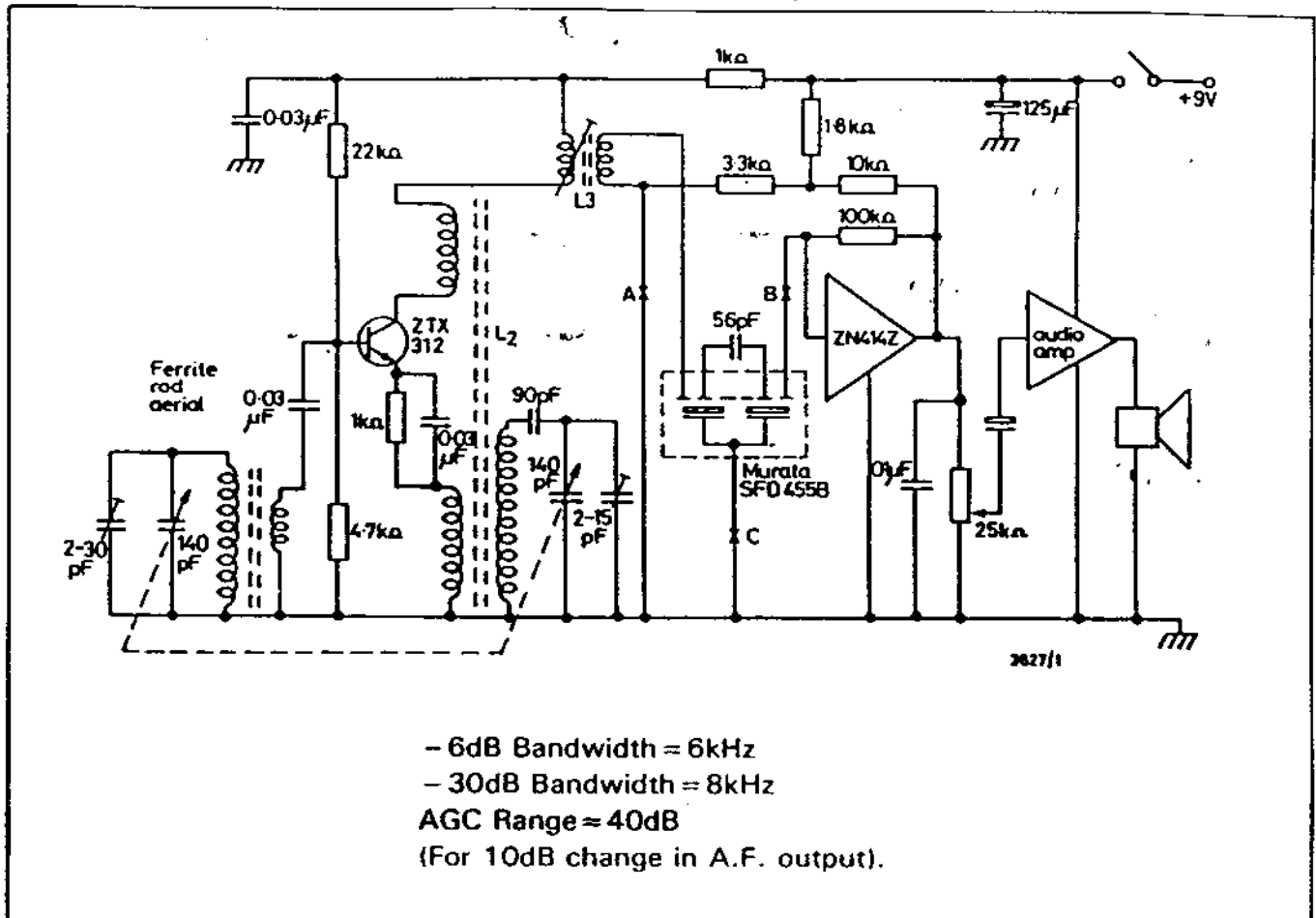
**FURTHER APPLICATIONS**

The ZN414Z is an extremely versatile device and, in a data sheet, it is not possible to show all its varied applications. A comprehensive applications note on the device is available which gives full details of various radio receivers, I.F. amplifiers and frequency standards together with comprehensive technical information.