

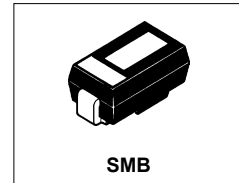

# MBRS190TR MBRS1100TR

SCHOTTKY RECTIFIER

1 Amp



### Major Ratings and Characteristics

Characteristics	MBR190TR MBR1100TR	Units
$I_{F(AV)}$ Rectangular waveform	1.0	A
$V_{RRM}$	90 - 100	V
$I_{FSM}$ @tp = 5 $\mu$ s sine	870	A
$V_F$ @1.0 Apk, $T_J=125^\circ\text{C}$	0.63	V
$T_J$ range	-55 to 175	$^\circ\text{C}$

### Description/Features

The MBR190TR, MBR1100TR surface-mount Schottky rectifier has been designed for applications requiring low forward drop and very small foot prints on PC boards. Typical applications are in disk drives, switching power supplies, converters, free-wheeling diodes, battery charging, and reverse battery protection.

- Small foot print, surface mountable
- Low forward voltage drop
- High frequency operation
- Guard ring for enhanced ruggedness and long term reliability

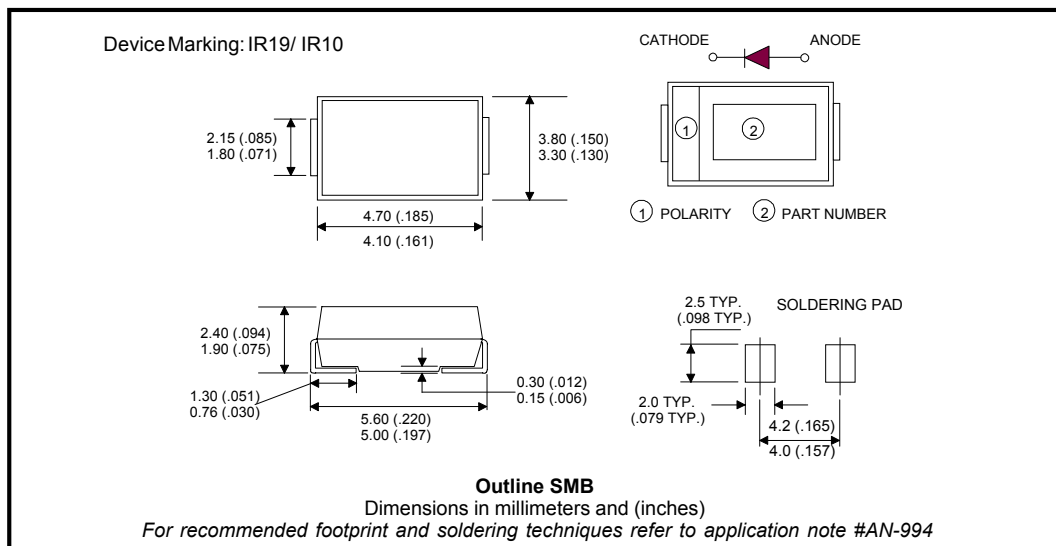

### Voltage Ratings

Part number	MBRS190TR	MBRS1100TR
V <sub>R</sub> Max. DC Reverse Voltage (V)	90	100
V <sub>RWM</sub> Max. Working Peak Reverse Voltage (V)		

### Absolute Maximum Ratings

Parameters	Value	Units	Conditions
I <sub>F(AV)</sub> Max. Average Forward Current	1.0	A	50% duty cycle @ T <sub>L</sub> = 147 °C, rectangular wave form
I <sub>FSM</sub> Max. Peak One Cycle Non-Repetitive Surge Current	870	A	5µs Sine or 3µs Rect. pulse 10ms Sine or 6ms Rect. pulse
	50		
E <sub>AS</sub> Non-Repetitive Avalanche Energy	5.0	mJ	T <sub>J</sub> = 25 °C, I <sub>AS</sub> = 0.5A, L = 10mH
I <sub>AR</sub> Repetitive Avalanche Current	0.2	A	

### Electrical Specifications

Parameters	Value	Units	Conditions	
V <sub>FM</sub> Max. Forward Voltage Drop (1) * See Fig. 1	0.78	V	@ 1A	T <sub>J</sub> = 25 °C
	0.62	V	@ 1A	T <sub>J</sub> = 125 °C
I <sub>RM</sub> Max. Reverse Leakage Current (1) * See Fig. 2	0.5	mA	T <sub>J</sub> = 25 °C	V <sub>R</sub> = rated V <sub>R</sub>
	1.0	mA	T <sub>J</sub> = 125 °C	
C <sub>T</sub> Typical Junction Capacitance	42	pF	V <sub>R</sub> = 5V <sub>DC</sub> , (test signal range 100kHz to 1MHz) 25 °C	
L <sub>S</sub> Typical Series Inductance	2.0	nH	Measured lead to lead 5mm from package body	
dv/dt Max. Volatge Rate of Charge (Rated V <sub>R</sub> )	10000	V/ µs		

(1) Pulse Width < 300µs, Duty Cycle < 2%

### Thermal-Mechanical Specifications

Parameters	Value	Units	Conditions
T <sub>J</sub> Max. Junction Temperature Range (*)	-55 to 175	°C	
T <sub>stg</sub> Max. Storage Temperature Range	-55 to 175	°C	
R <sub>thJL</sub> Max. Thermal Resistance Junction to Lead (**)	36	°C/W	DC operation (See Fig. 4)
R <sub>thJA</sub> Max. Thermal Resistance Junction to Ambient	80	°C/W	DC operation
wt Approximate Weight	0.10(0.003)	g (oz.)	
Case Style	SMB		Similar to DO-214AA
Device Marking	IR19-IR10		

(\*)  $\frac{dP_{tot}}{dT_J} < \frac{1}{R_{th(j-a)}}$  thermal runaway condition for a diode on its own heatsink

(\*\*) Mounted 1 inch square PCB

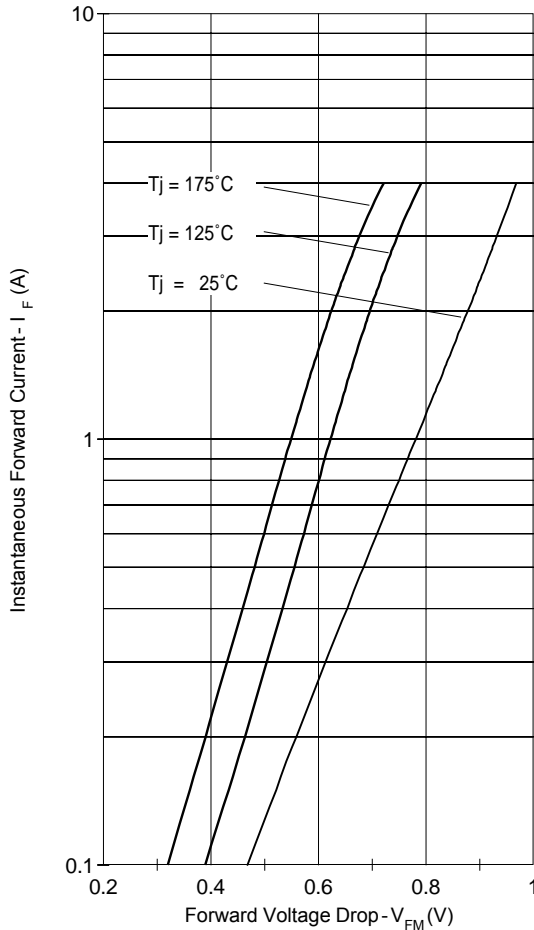

Fig. 1 - Maximum Forward Voltage Drop Characteristics

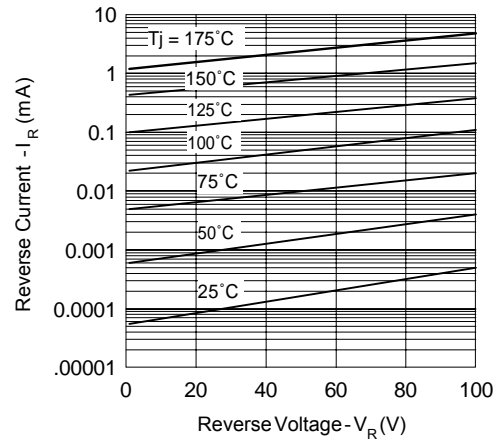

Fig. 2 - Typical Peak Reverse Current Vs. Reverse Voltage

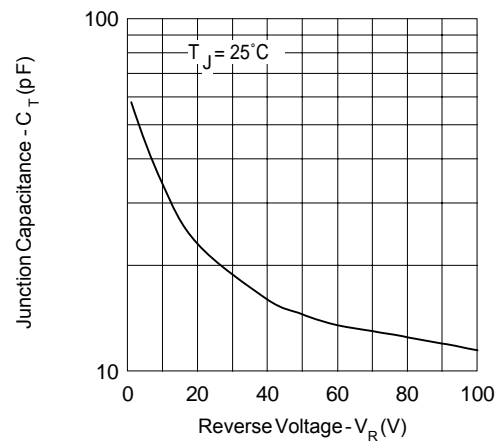

Fig. 3 - Typical Junction Capacitance Vs. Reverse Voltage

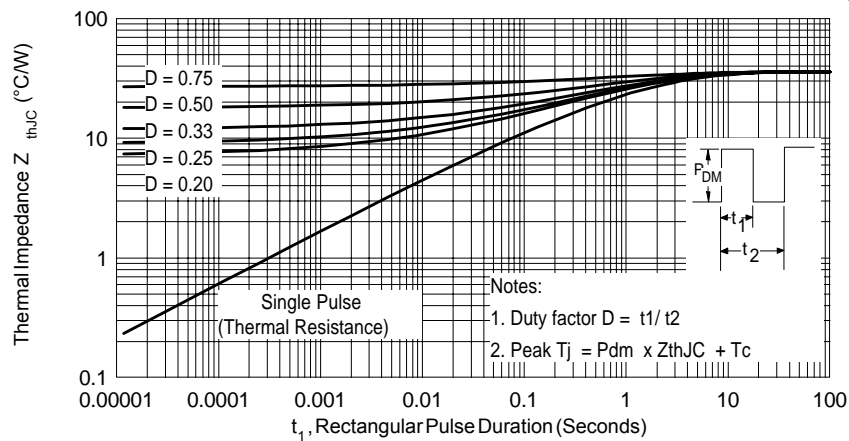

Fig. 4 - Max. Thermal Impedance  $Z_{thJC}$  Characteristics (Per Leg)

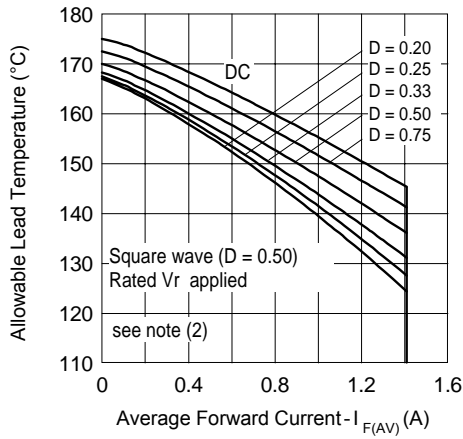

Fig. 4 - Maximum Average Forward Current Vs. Allowable Lead Temperature

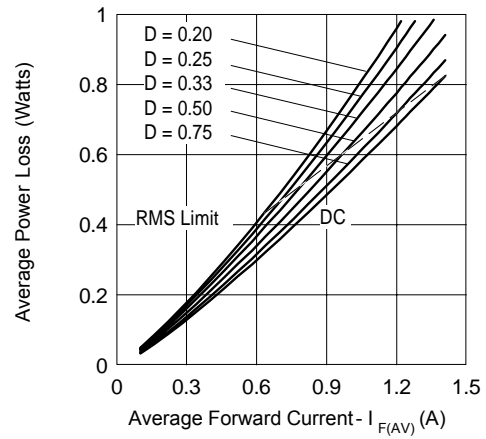

Fig. 5 - Maximum Average Forward Dissipation Vs. Average Forward Current

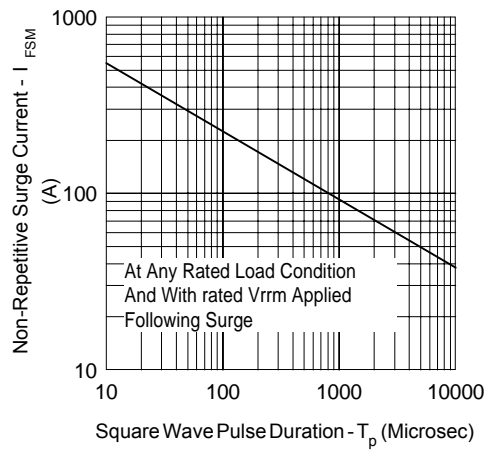
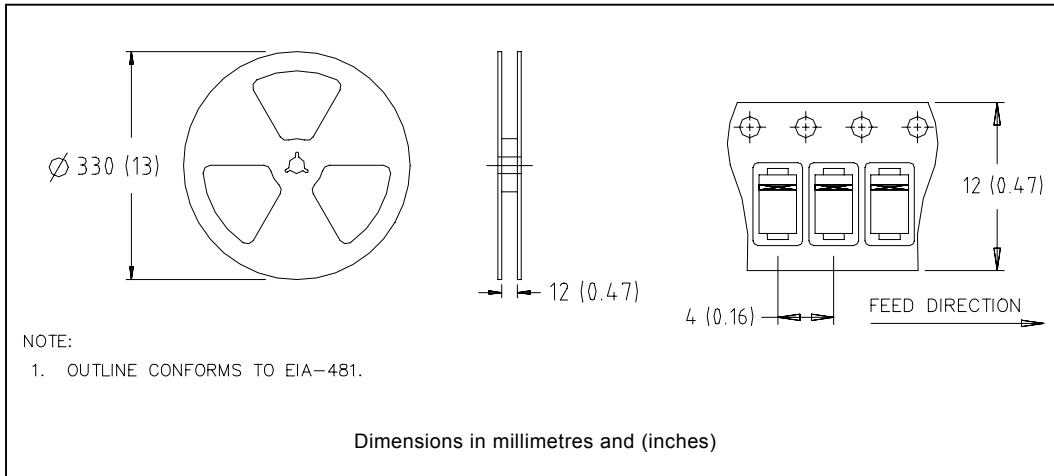

Fig. 6 - Maximum Peak Surge Forward Current Vs. Pulse Duration

- (2) Formula used:  $T_C = T_J - (Pd + Pd_{REV}) \times R_{thJC}$ ;  
 $Pd = \text{Forward Power Loss} = I_{F(AV)} \times V_{FM} @ (I_{F(AV)} / D)$  (see Fig. 6);  
 $Pd_{REV} = \text{Inverse Power Loss} = V_{R1} \times I_R (1 - D); I_R @ V_{R1} = 80\% \text{ rated } V_R$

**Tape & Reel Information**



**Marking & Identification**

Each device has 2 rows for identification. The first row designates the device as manufactured by International Rectifier as indicated by the letters "IR", and the Part Number (indicates the current and the voltage rating). The second row indicates the year, the week of manufacturing and the Site ID.

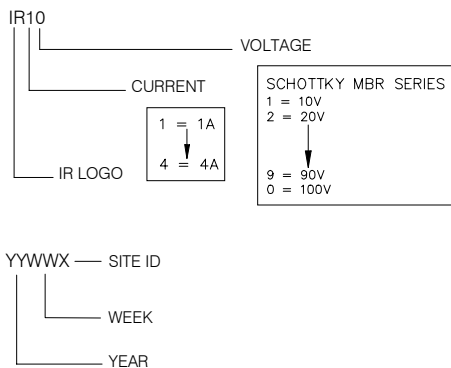
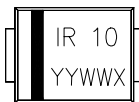

**Ordering Information**

**MBRS1100TR - TAPE AND REEL**

WHEN ORDERING, INDICATE THE PART NUMBER AND THE QUANTITY ( IN MULTIPLES OF 3000 PIECES).

EXAMPLE: MBRS1100TR - 6000 PIECES

MBRS190TR, MBRS1100TR

Bulletin PD-20592 rev. C 05/02

International  
**IOR** Rectifier

---

Data and specifications subject to change without notice.  
This product has been designed and qualified for Industrial Level.  
Qualification Standards can be found on IR's Web site.

International  
**IOR** Rectifier

**IR WORLD HEADQUARTERS:** 233 Kansas St., El Segundo, California 90245, USA Tel: (310) 252-7105  
TAC Fax: (310) 252-7309  
Visit us at [www.irf.com](http://www.irf.com) for sales contact information. 05/02