

MC10H106

Triple 4-3-3-Input NOR Gate

The MC10H106 is a triple 4-3-3 input NOR gate. This 10H part is a functional/pinout duplication of the standard MECL 10K family part, with 100% improvement in propagation delay and no increase in power– supply current.

- Propagation Delay, 1.0 ns Typical
- Improved Noise Margin 150 mV (Over Operating Voltage and Temperature Range)
- Voltage Compensated
- MECL 10K–Compatible

LOGIC DIAGRAM

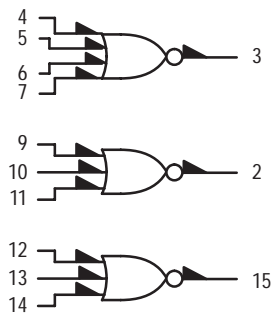

VCC1 = PIN 1
VCC2 = PIN 16
VEE = PIN 8

DIP PIN ASSIGNMENT

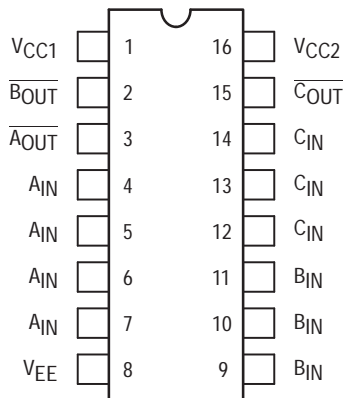

Pin assignment is for Dual–in–Line Package.
For PLCC pin assignment, see the Pin Conversion Tables on page 18 of the ON Semiconductor MECL Data Book (DL122/D).



ON Semiconductor

<http://onsemi.com>

MARKING DIAGRAMS

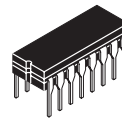

CDIP–16
L SUFFIX
CASE 620A

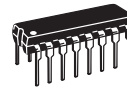
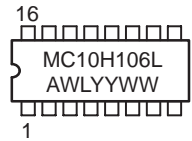

PDIP–16
P SUFFIX
CASE 648

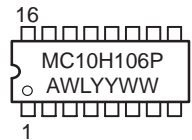

PLCC–20
FN SUFFIX
CASE 775

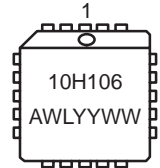

A = Assembly Location
WL = Wafer Lot
YY = Year
WW = Work Week

ORDERING INFORMATION

Device	Package	Shipping
MC10H106L	CDIP–16	25 Units/Rail
MC10H106P	PDIP–16	25 Units/Rail
MC10H106FN	PLCC–20	46 Units/Rail

MC10H106

MAXIMUM RATINGS

Symbol	Characteristic	Rating	Unit
V_{EE}	Power Supply ($V_{CC} = 0$)	-8.0 to 0	Vdc
V_I	Input Voltage ($V_{CC} = 0$)	0 to V_{EE}	Vdc
I_{out}	Output Current – Continuous – Surge	50 100	mA
T_A	Operating Temperature Range	0 to +75	°C
T_{stg}	Storage Temperature Range – Plastic – Ceramic	-55 to +150 -55 to +165	°C °C

ELECTRICAL CHARACTERISTICS ($V_{EE} = -5.2\text{ V} \pm 5\%$) (See Note 1.)

Symbol	Characteristic	0°		25°		75°		Unit
		Min	Max	Min	Max	Min	Max	
I_E	Power Supply Current	–	23	–	21	–	23	mA
I_{inH}	Input Current High	–	500	–	310	–	310	μA
I_{inL}	Input Current Low	0.5	–	0.5	–	0.3	–	μA
V_{OH}	High Output Voltage	-1.02	-0.84	-0.98	-0.81	-0.92	-0.735	Vdc
V_{OL}	Low Output Voltage	-1.95	-1.63	-1.95	-1.63	-1.95	-1.60	Vdc
V_{IH}	High Input Voltage	-1.17	-0.84	-1.13	-0.81	-1.07	-0.735	Vdc
V_{IL}	Low Input Voltage	-1.95	-1.48	-1.95	-1.48	-1.95	-1.45	Vdc

AC PARAMETERS

t_{pd}	Propagation Delay	0.5	1.3	0.5	1.5	0.55	1.55	ns
t_r	Rise Time	0.5	1.7	0.5	1.8	0.55	1.9	ns
t_f	Fall Time	0.5	1.7	0.5	1.8	0.55	1.9	ns

- Each MECL 10H series circuit has been designed to meet the dc specifications shown in the test table, after thermal equilibrium has been established. The circuit is in a test socket or mounted on a printed circuit board and transverse air flow greater than 500 lfpm is maintained. Outputs are terminated through a 50-ohm resistor to -2.0 volts.

MC10H106

PACKAGE DIMENSIONS

PLCC-20
FN SUFFIX
PLASTIC PLCC PACKAGE
CASE 775-02
ISSUE C

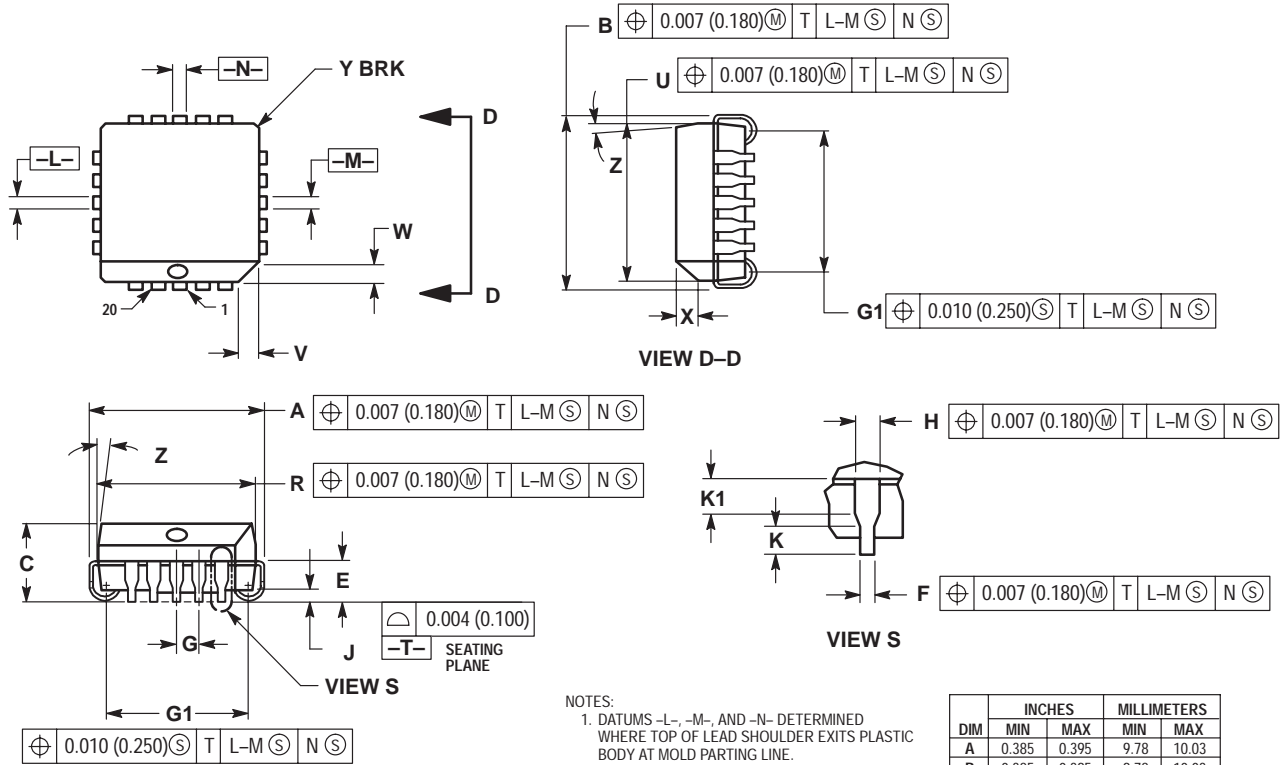

NOTES:

- DATUMS -L-, -M-, AND -N- DETERMINED WHERE TOP OF LEAD SHOULDER EXITS PLASTIC BODY AT MOLD PARTING LINE.
- DIMENSION G1, TRUE POSITION TO BE MEASURED AT DATUM -T-, SEATING PLANE.
- DIMENSIONS R AND U DO NOT INCLUDE MOLD FLASH. ALLOWABLE MOLD FLASH IS 0.010 (0.250) PER SIDE.
- DIMENSIONING AND TOLERANCING PER ANSI Y14.5M, 1982.
- CONTROLLING DIMENSION: INCH.
- THE PACKAGE TOP MAY BE SMALLER THAN THE PACKAGE BOTTOM BY UP TO 0.012 (0.300). DIMENSIONS R AND U ARE DETERMINED AT THE OUTERMOST EXTREMES OF THE PLASTIC BODY EXCLUSIVE OF MOLD FLASH, TIE BAR BURRS, GATE BURRS AND INTERLEAD FLASH, BUT INCLUDING ANY MISMATCH BETWEEN THE TOP AND BOTTOM OF THE PLASTIC BODY.
- DIMENSION H DOES NOT INCLUDE DAMBAR PROTRUSION OR INTRUSION. THE DAMBAR PROTRUSION(S) SHALL NOT CAUSE THE H DIMENSION TO BE GREATER THAN 0.037 (0.940). THE DAMBAR INTRUSION(S) SHALL NOT CAUSE THE H DIMENSION TO BE SMALLER THAN 0.025 (0.635).

DIM	INCHES		MILLIMETERS	
	MIN	MAX	MIN	MAX
A	0.385	0.395	9.78	10.03
B	0.385	0.395	9.78	10.03
C	0.165	0.180	4.20	4.57
E	0.090	0.110	2.29	2.79
F	0.013	0.019	0.33	0.48
G	0.050 BSC		1.27 BSC	
H	0.026	0.032	0.66	0.81
J	0.020	---	0.51	---
K	0.025	---	0.64	---
R	0.350	0.356	8.89	9.04
U	0.350	0.356	8.89	9.04
V	0.042	0.048	1.07	1.21
W	0.042	0.048	1.07	1.21
X	0.042	0.056	1.07	1.42
Y	---	0.020	---	0.50
Z	2°	10°	2°	10°
G1	0.310	0.330	7.88	8.38
K1	0.040	---	1.02	---

MC10H106

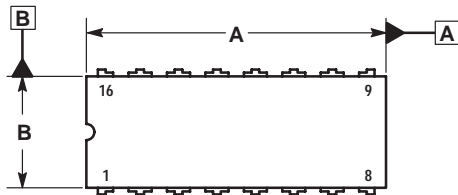

CDIP-16 L SUFFIX CERAMIC DIP PACKAGE CASE 620A-01 ISSUE O

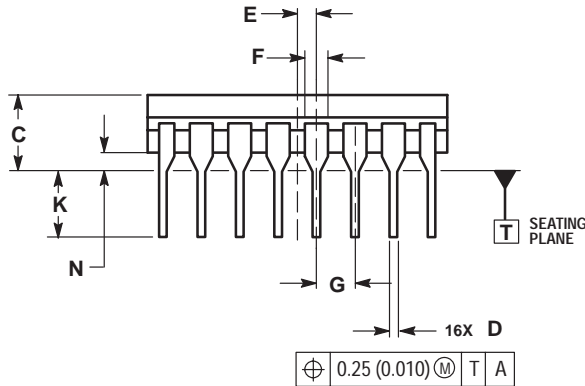
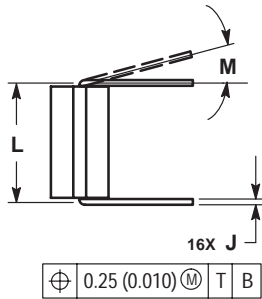

- NOTES:
1. DIMENSIONING AND TOLERANCING PER ASME Y14.5M, 1994.
 2. CONTROLLING DIMENSION: INCH.
 3. DIMENSION L TO CENTER OF LEAD WHEN FORMED PARALLEL.
 4. DIMENSION F MAY NARROW TO 0.76 (0.030) WHERE THE LEAD ENTERS THE CERAMIC BODY.
 5. THIS DRAWING REPLACES OBSOLETE CASE OUTLINE 620-10.

DIM	INCHES		MILLIMETERS	
	MIN	MAX	MIN	MAX
A	0.750	0.785	19.05	19.93
B	0.240	0.295	6.10	7.49
C	---	0.200	---	5.08
D	0.015	0.020	0.39	0.50
E	0.050 BSC		1.27 BSC	
F	0.055	0.065	1.40	1.65
G	0.100 BSC		2.54 BSC	
H	0.008	0.015	0.21	0.38
K	0.125	0.170	3.18	4.31
L	0.300 BSC		7.62 BSC	
M	0°	15°	0°	15°
N	0.020	0.040	0.51	1.01

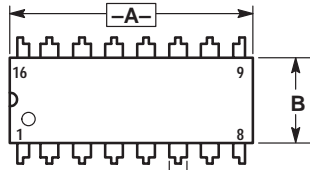

PDIP-16 P SUFFIX PLASTIC DIP PACKAGE CASE 648-08 ISSUE R

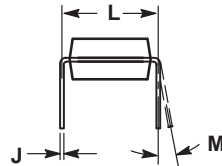
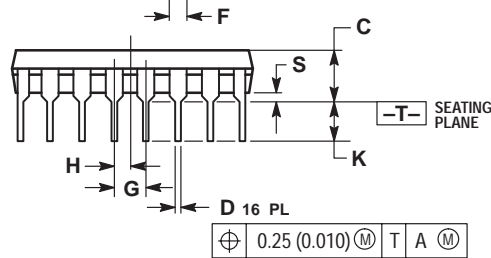

- NOTES:
1. DIMENSIONING AND TOLERANCING PER ANSI Y14.5M, 1982.
 2. CONTROLLING DIMENSION: INCH.
 3. DIMENSION L TO CENTER OF LEADS WHEN FORMED PARALLEL.
 4. DIMENSION B DOES NOT INCLUDE MOLD FLASH.
 5. ROUNDED CORNERS OPTIONAL.

DIM	INCHES		MILLIMETERS	
	MIN	MAX	MIN	MAX
A	0.740	0.770	18.80	19.55
B	0.250	0.270	6.35	6.85
C	0.145	0.175	3.69	4.44
D	0.015	0.021	0.39	0.53
F	0.040	0.70	1.02	1.77
G	0.100 BSC		2.54 BSC	
H	0.050 BSC		1.27 BSC	
J	0.008	0.015	0.21	0.38
K	0.110	0.130	2.80	3.30
L	0.295	0.305	7.50	7.74
M	0°	10°	0°	10°
S	0.020	0.040	0.51	1.01

ON Semiconductor and  are trademarks of Semiconductor Components Industries, LLC (SCILLC). SCILLC reserves the right to make changes without further notice to any products herein. SCILLC makes no warranty, representation or guarantee regarding the suitability of its products for any particular purpose, nor does SCILLC assume any liability arising out of the application or use of any product or circuit, and specifically disclaims any and all liability, including without limitation special, consequential or incidental damages. "Typical" parameters which may be provided in SCILLC data sheets and/or specifications can and do vary in different applications and actual performance may vary over time. All operating parameters, including "Typicals" must be validated for each customer application by customer's technical experts. SCILLC does not convey any license under its patent rights nor the rights of others. SCILLC products are not designed, intended, or authorized for use as components in systems intended for surgical implant into the body, or other applications intended to support or sustain life, or for any other application in which the failure of the SCILLC product could create a situation where personal injury or death may occur. Should Buyer purchase or use SCILLC products for any such unintended or unauthorized application, Buyer shall indemnify and hold SCILLC and its officers, employees, subsidiaries, affiliates, and distributors harmless against all claims, costs, damages, and expenses, and reasonable attorney fees arising out of, directly or indirectly, any claim of personal injury or death associated with such unintended or unauthorized use, even if such claim alleges that SCILLC was negligent regarding the design or manufacture of the part. SCILLC is an Equal Opportunity/Affirmative Action Employer.

PUBLICATION ORDERING INFORMATION

NORTH AMERICA Literature Fulfillment:
Literature Distribution Center for ON Semiconductor
P.O. Box 5163, Denver, Colorado 80217 USA
Phone: 303-675-2175 or 800-344-3860 Toll Free USA/Canada
Fax: 303-675-2176 or 800-344-3867 Toll Free USA/Canada
Email: ONlit@hibbertco.com
Fax Response Line: 303-675-2167 or 800-344-3810 Toll Free USA/Canada

N. American Technical Support: 800-282-9855 Toll Free USA/Canada

EUROPE: LDC for ON Semiconductor – European Support
German Phone: (+1) 303-308-7140 (M-F 1:00pm to 5:00pm Munich Time)
Email: ONlit-german@hibbertco.com
French Phone: (+1) 303-308-7141 (M-F 1:00pm to 5:00pm Toulouse Time)
Email: ONlit-french@hibbertco.com
English Phone: (+1) 303-308-7142 (M-F 12:00pm to 5:00pm UK Time)
Email: ONlit@hibbertco.com

EUROPEAN TOLL-FREE ACCESS*: 00-800-4422-3781
*Available from Germany, France, Italy, England, Ireland

CENTRAL/SOUTH AMERICA:
Spanish Phone: 303-308-7143 (Mon-Fri 8:00am to 5:00pm MST)
Email: ONlit-spanish@hibbertco.com

ASIA/PACIFIC: LDC for ON Semiconductor – Asia Support
Phone: 303-675-2121 (Tue-Fri 9:00am to 1:00pm, Hong Kong Time)
Toll Free from Hong Kong & Singapore:
001-800-4422-3781
Email: ONlit-asia@hibbertco.com

JAPAN: ON Semiconductor, Japan Customer Focus Center
4-32-1 Nishi-Gotanda, Shinagawa-ku, Tokyo, Japan 141-0031
Phone: 81-3-5740-2745
Email: r14525@onsemi.com

ON Semiconductor Website: <http://onsemi.com>

For additional information, please contact your local Sales Representative.