

# Product Preview

## 32K x 8 Bit Static Random Access Memory

The MCM6706B is a 262,144 bit static random access memory organized as 32,768 words of 8 bits. Static design eliminates the need for external clocks or timing strobes.

Output enable ( $\bar{G}$ ) is a special control feature that provides increased system flexibility and eliminates bus contention problems.

The MCM6706B is available in a 300 mil, 28-lead surface-mount SOJ package.

- Single 5.0 V  $\pm$  10% Power Supply
- Fully Static — No Clock or Timing Strokes Necessary
- All Inputs and Outputs Are TTL Compatible
- Three State Outputs
- Fast Access Times: MCM6706B-8 = 8 ns  
MCM6706B-10 = 10 ns  
MCM6706B-12 = 12 ns

### BLOCK DIAGRAM

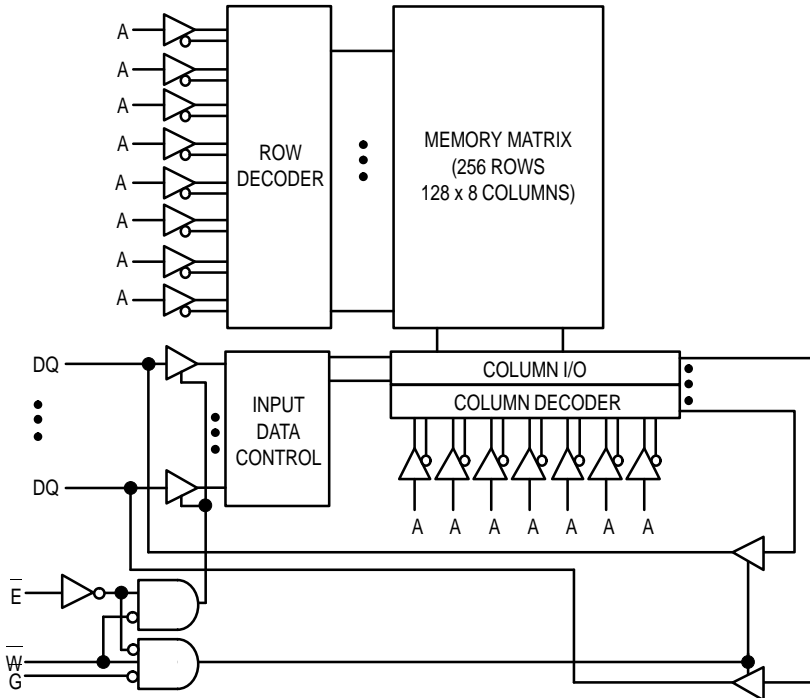

## MCM6706B

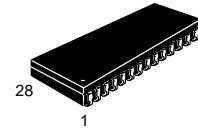

**J PACKAGE**  
**300 MIL SOJ**  
**CASE 810B-03**

### PIN ASSIGNMENT

A	1	28	V <sub>CC</sub>
A	2	27	$\bar{W}$
A	3	26	A
A	4	25	A
A	5	24	A
A	6	23	A
A	7	22	$\bar{G}$
A	8	21	A
A	9	20	$\bar{E}$
A	10	19	DQ
DQ	11	18	DQ
DQ	12	17	DQ
DQ	13	16	DQ
V <sub>SS</sub>	14	15	DQ

### PIN NAMES

A	.....	Address Input
$\bar{W}$	.....	Write Enable
$\bar{E}$	.....	Chip Enable
$\bar{G}$	.....	Output Enable
DQ	.....	Data Input/Output
V <sub>CC</sub>	.....	+ 5.0 V Power Supply
V <sub>SS</sub>	.....	Ground

This document contains information on a new product under development. Motorola reserves the right to change or discontinue this product without notice.

REV 1  
10/9/96

**TRUTH TABLE** (X = Don't Care)

E	G	W	Mode	I/O Pin	Cycle
H	X	X	Not Selected	High-Z	—
L	H	H	Read	High-Z	—
L	L	H	Read	D <sub>out</sub>	Read Cycle
L	X	L	Write	D <sub>in</sub>	Write Cycle

**ABSOLUTE MAXIMUM RATINGS** (See Note)

Rating	Symbol	Value	Unit
Power Supply Voltage	V <sub>CC</sub>	- 0.5 to + 7.0	V
Voltage Relative to V <sub>SS</sub> for Any Pin Except V <sub>CC</sub>	V <sub>in</sub> , V <sub>out</sub>	- 0.5 to V <sub>CC</sub> + 0.5	V
Output Current	I <sub>out</sub>	± 30	mA
Power Dissipation	P <sub>D</sub>	2.0	W
Temperature Under Bias	T <sub>bias</sub>	- 10 to + 85	°C
Operating Temperature	T <sub>A</sub>	0 to + 70	°C
Storage Temperature — Plastic	T <sub>stg</sub>	- 55 to + 125	°C

NOTE: Permanent device damage may occur if ABSOLUTE MAXIMUM RATINGS are exceeded. Functional operation should be restricted to RECOMMENDED OPERATING CONDITIONS. Exposure to higher than recommended voltages for extended periods of time could affect device reliability.

This device contains circuitry to protect the inputs against damage due to high static voltages or electric fields; however, it is advised that normal precautions be taken to avoid application of any voltage higher than maximum rated voltages to this high-impedance circuit.

This BiCMOS memory circuit has been designed to meet the dc and ac specifications shown in the tables, after thermal equilibrium has been established. The circuit is in a test socket or mounted on a printed circuit board and transverse air flow of at least 500 linear feet per minute is maintained.

**DC OPERATING CONDITIONS AND CHARACTERISTICS**

(V<sub>CC</sub> = 5.0 V ± 10%, T<sub>A</sub> = 0 to 70°C, Unless Otherwise Noted)

**RECOMMENDED OPERATING CONDITIONS**

Parameter	Symbol	Min	Typ	Max	Unit
Supply Voltage (Operating Voltage Range)	V <sub>CC</sub>	4.5	5.0	5.5	V
Input High Voltage	V <sub>IH</sub>	2.2	—	V <sub>CC</sub> + 0.3*	V
Input Low Voltage	V <sub>IL</sub>	- 0.5**	—	0.8	V

\* V<sub>IH</sub> (max) = V<sub>CC</sub> + 0.3 V dc; V<sub>IH</sub> (max) = V<sub>CC</sub> + 2.0 V ac (pulse width ≤ 2.0 ns) or I ≤ 30.0 mA.

\*\* V<sub>IL</sub> (min) = - 0.5 V dc @ 30.0 mA; V<sub>IL</sub> (min) = - 2.0 V ac (pulse width ≤ 2.0 ns) or I ≤ 30.0 mA.

**DC CHARACTERISTICS**

Parameter	Symbol	Min	Max	Unit
Input Leakage Current (All Inputs, V <sub>in</sub> = 0 to V <sub>CC</sub> )	I <sub>kg(I)</sub>	—	± 1.0	μA
Output Leakage Current (E = V <sub>IH</sub> or G = V <sub>IH</sub> ; V <sub>out</sub> = 0 to V <sub>CC</sub> )	I <sub>kg(O)</sub>	—	± 1.0	μA
Output High Voltage (I <sub>OH</sub> = - 4.0 mA)	V <sub>OH</sub>	2.4	—	V
Output Low Voltage (I <sub>OL</sub> = + 8.0 mA)	V <sub>OL</sub>	—	0.4	V

**POWER SUPPLY CURRENTS**

Parameter	Symbol	6706B-8	6706B-10	6706B-12	Unit	Notes
AC Active Supply Current (I <sub>out</sub> = 0 mA, V <sub>CC</sub> = max, f = f <sub>max</sub> )	I <sub>CCA</sub>	195	185	175	mA	1, 2, 3
AC Standby Current (E = V <sub>IH</sub> , V <sub>CC</sub> = max, f = f <sub>max</sub> )	I <sub>SB1</sub>	75	70	65	mA	1, 2, 3
CMOS Standby Current (V <sub>CC</sub> = max, f = 0 MHz, E ≥ V <sub>CC</sub> - 0.2 V, V <sub>in</sub> ≤ V <sub>SS</sub> , or ≥ V <sub>CC</sub> - 0.2 V)	I <sub>SB2</sub>	20	20	20	mA	

NOTES:

- Reference AC Operating Conditions and Characteristics for input and timing (V<sub>IH</sub>/V<sub>IL</sub>, t<sub>r</sub>/t<sub>f</sub>, pulse level 0 to 3 V, V<sub>IH</sub> = 3 V).
- All addresses transition simultaneously low (LSB) and then high (MSB).
- Data states are all zero.

**CAPACITANCE** (f = 1.0 MHz, dV = 3.0 V, T<sub>A</sub> = 25°C, Periodically Sampled Rather Than 100% Tested)

Parameter	Symbol	Max	Unit
Address Input Capacitance	C <sub>in</sub>	5	pF
Control Pin Input Capacitance (E, G, W)	C <sub>in</sub>	6	pF
I/O Capacitance	C <sub>out</sub>	6	pF

**AC OPERATING CONDITIONS AND CHARACTERISTICS**

(V<sub>CC</sub> = 5.0 V ± 10%, T<sub>A</sub> = 0 to + 70°C, Unless Otherwise Noted)

Input Timing Measurement Reference Level ..... 1.5 V      Output Timing Measurement Reference Level ..... 1.5 V  
 Input Pulse Levels ..... 0 to 3.0 V      Output Load ..... See Figure 1a  
 Input Rise/Fall Time ..... 2 ns

**READ CYCLE** (See Notes 1 and 2)

Parameter	Symbol	MCM6706B-8		MCM6706B-10		MCM6706B-12		Unit	Notes
		Min	Max	Min	Max	Min	Max		
Read Cycle Time	t <sub>AVAV</sub>	8	—	10	—	12	—	ns	3
Address Access Time	t <sub>AVQV</sub>	—	8	—	10	—	12	ns	
Chip Enable Access Time	t <sub>ELQV</sub>	—	8	—	10	—	12	ns	
Output Enable Access Time	t <sub>GLQV</sub>	—	4	—	5	—	6	ns	
Output Hold from Address Change	t <sub>AXQX</sub>	3	—	3	—	3	—	ns	
Chip Enable Low to Output Active	t <sub>ELQX</sub>	1	—	1	—	1	—	ns	4, 5, 6
Chip Enable High to Output High-Z	t <sub>EHQZ</sub>	—	4.5	—	5	—	6	ns	4, 5, 6
Output Enable Low to Output Active	t <sub>GLQX</sub>	0	—	0	—	0	—	ns	4, 5, 6
Output Enable High to Output High-Z	t <sub>GHQZ</sub>	—	4	—	5	—	6	ns	4, 5, 6

**NOTES:**

1. W is high for read cycle.
2. Product sensitivities to noise require proper grounding and decoupling of power supplies as well as minimization or elimination of bus contention conditions during read and write cycles.
3. All read cycle timing is referenced from the last valid address to the first transitioning address.
4. At any given voltage and temperature, t<sub>EHQZ</sub> max < t<sub>ELQX</sub> min, and t<sub>GHQZ</sub> max < t<sub>GLQX</sub> min, both for a given device and from device to device.
5. Transition is measured 200 mV from steady-state voltage with load of Figure 1b.
6. This parameter is sampled and not 100% tested.
7. Device is continuously selected (E = V<sub>IL</sub>, G = V<sub>IL</sub>).
8. Addresses valid prior to or coincident with E going low.

**TIMING LIMITS**

The table of timing values shows either a minimum or a maximum limit for each parameter. Input requirements are specified from the external system point of view. Thus, address setup time is shown as a minimum since the system must supply at least that much time. On the other hand, responses from the memory are specified from the device point of view. Thus, the access time is shown as a maximum since the device never provides data later than that time.

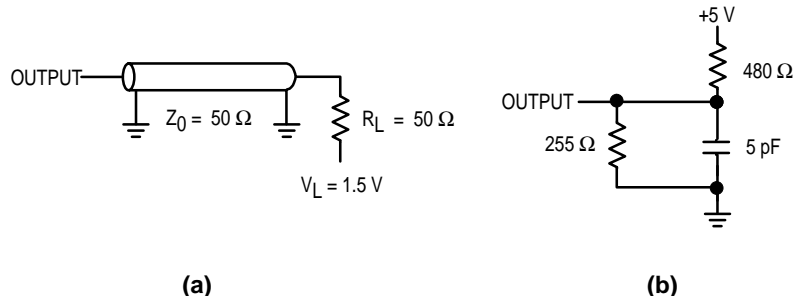
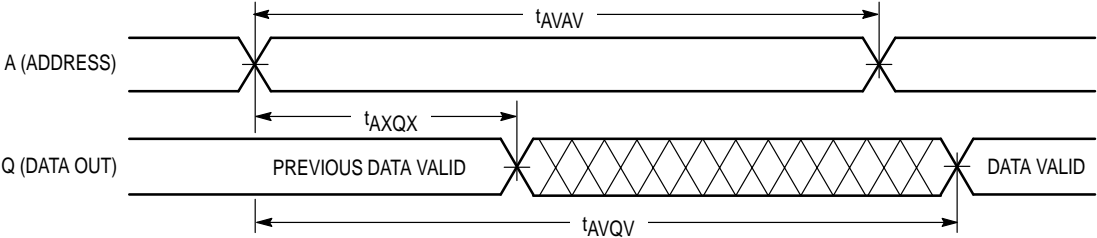
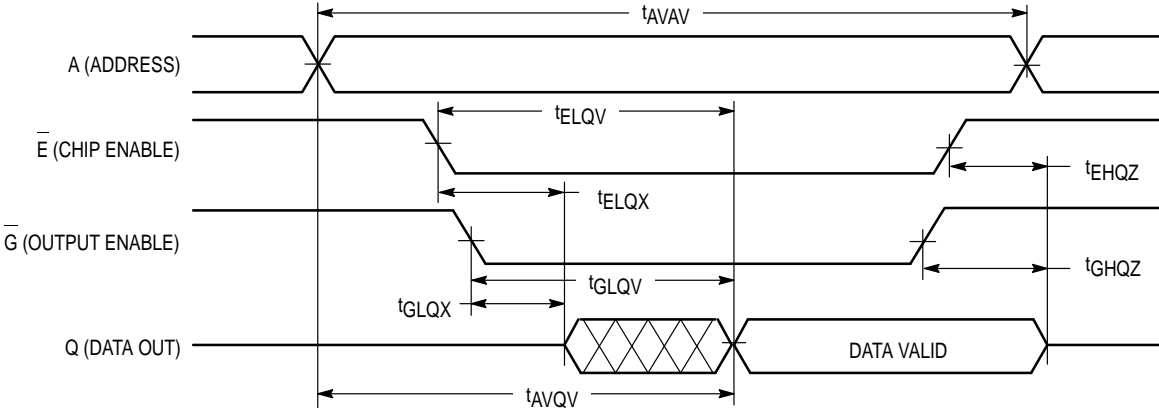

Figure 1. AC Test Loads

**READ CYCLE 1 (See Note 7)**



**READ CYCLE 2 (See Note 8)**



**WRITE CYCLE 1** ( $\bar{W}$  Controlled, See Notes 1 and 2)

Parameter	Symbol	MCM6706B-8		MCM6706B-10		MCM6706B-12		Unit	Notes
		Min	Max	Min	Max	Min	Max		
Write Cycle Time	$t_{AVAV}$	8	—	10	—	12	—	ns	3
Address Setup Time	$t_{AVWL}$	0	—	0	—	0	—	ns	
Address Valid to End of Write	$t_{AVWH}$	8	—	9	—	10	—	ns	
Write Pulse Width	$t_{WLWH}$ , $t_{WLEH}$	8	—	9	—	10	—	ns	
Data Valid to End of Write	$t_{DVWH}$	4	—	5	—	6	—	ns	
Data Hold Time	$t_{WHDX}$	0	—	0	—	0	—	ns	
Write Low to Data High-Z	$t_{WLQZ}$	—	4	—	5	—	6	ns	4, 5, 6
Write High to Output Active	$t_{WHQX}$	3	—	3	—	3	—	ns	4, 5, 6
Write Recovery Time	$t_{WHAX}$	0	—	0	—	0	—	ns	

NOTES:

1. A write occurs during the overlap of  $\bar{E}$  low and  $\bar{W}$  low.
2. Product sensitivities to noise require proper grounding and decoupling of power supplies as well as minimization or elimination of bus contention conditions during read and write cycles.
3. All write cycle timings are referenced from the last valid address to the first transitioning address.
4. Transition is measured 200 mV from steady-state voltage with load of Figure 1b.
5. Parameter is sampled and not 100% tested.
6. At any given voltage and temperature,  $t_{WLQZ}$  max is  $< t_{WHQX}$  min both for a given device and from device to device.

**WRITE CYCLE 1**

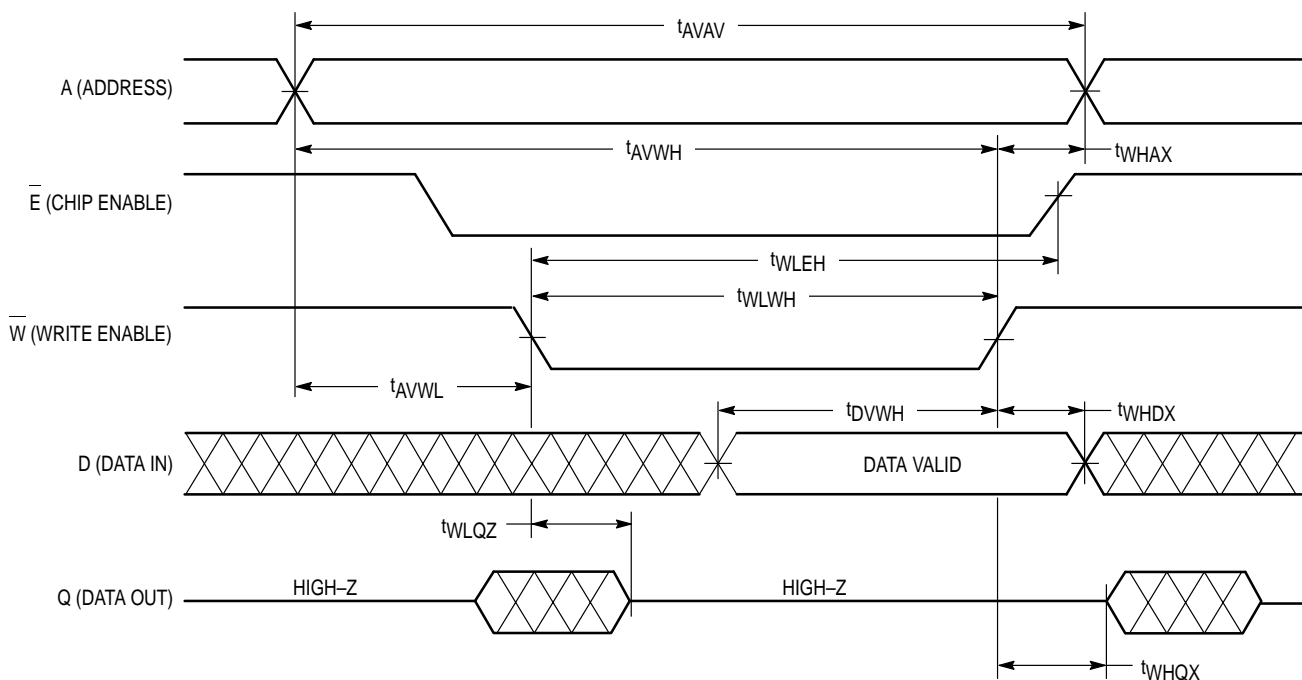

**WRITE CYCLE 2** ( $\bar{E}$  Controlled, See Notes 1 and 2)

Parameter	Symbol	MCM6706B-8		MCM6706B-10		MCM6706B-12		Unit	Notes
		Min	Max	Min	Max	Min	Max		
Write Cycle Time	$t_{AVAV}$	8	—	10	—	12	—	ns	3
Address Setup Time	$t_{AVEL}$	0	—	0	—	0	—	ns	
Address Valid to End of Write	$t_{AVEH}$	8	—	9	—	10	—	ns	
Chip Enable to End of Write	$t_{ELWH}, t_{ELEH}$	7	—	8	—	9	—	ns	4,5
Data Valid to End of Write	$t_{DVEH}$	4	—	5	—	6	—	ns	
Data Hold Time	$t_{EHDX}$	0	—	0	—	0	—	ns	
Write Recovery Time	$t_{EHAX}$	0	—	0	—	0	—	ns	

NOTES:

1. A write occurs during the overlap of  $\bar{E}$  low and  $\bar{W}$  low.
2. Product sensitivities to noise require proper grounding and decoupling of power supplies as well as minimization or elimination of bus contention conditions during read and write cycles.
3. All write cycle timing is referenced from the last valid address to the first transitioning address.
4. If  $\bar{E}$  goes low coincident with or after  $\bar{W}$  goes low, the output will remain in a high impedance condition.
5. If  $\bar{E}$  goes high coincident with or before  $\bar{W}$  goes high, the output will remain in a high impedance condition.

**WRITE CYCLE 2**

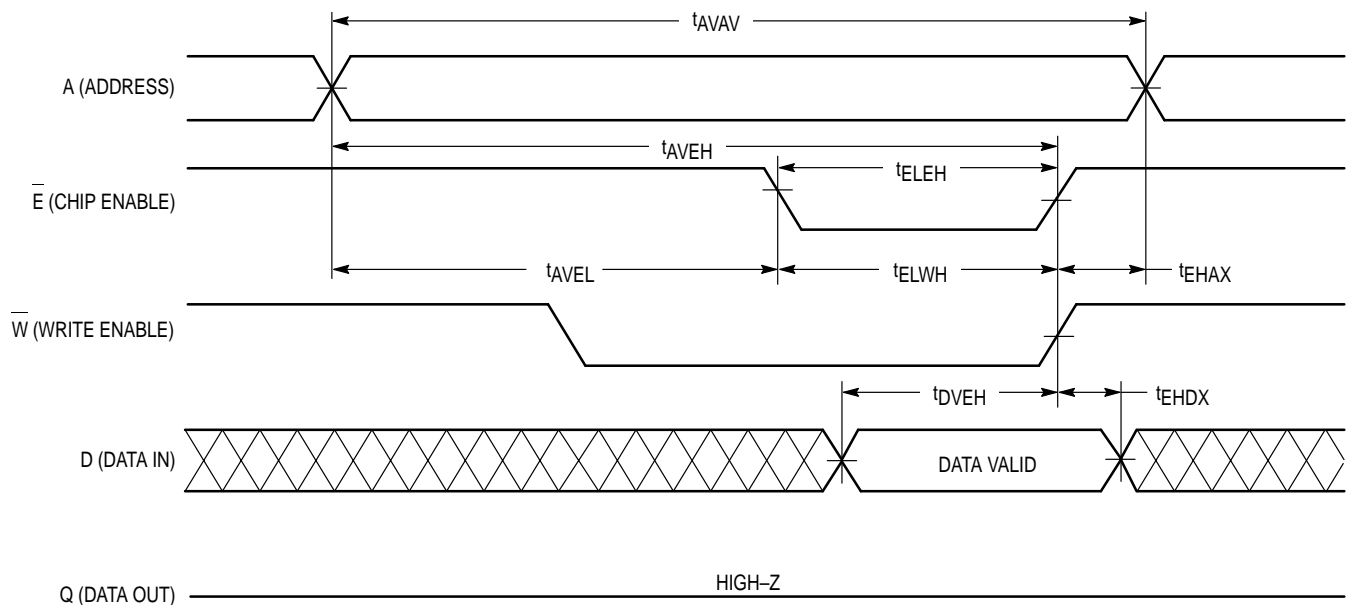

# PACKAGE DIMENSIONS

## J PACKAGE 300 MIL SOJ CASE 810B-03

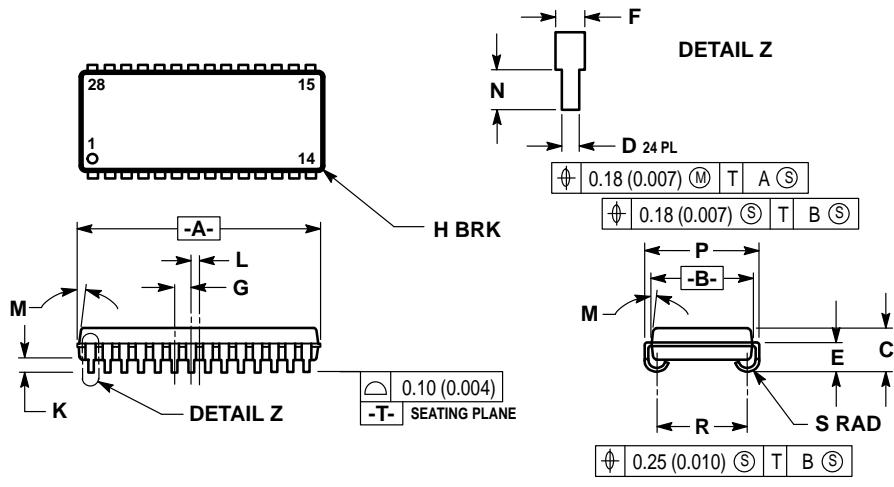

- NOTES:
1. DIMENSIONING AND TOLERANCING PER ANSI Y14.5M, 1982.
  2. DIMENSION A & B DO NOT INCLUDE MOLD PROTRUSION. MOLD PROTRUSION SHALL NOT EXCEED 0.15 (0.006) PER SIDE.
  3. CONTROLLING DIMENSION: INCH.
  4. DIM R TO BE DETERMINED AT DATUM -T-.

DIM	MILLIMETERS		INCHES	
	MIN	MAX	MIN	MAX
A	18.29	18.54	0.720	0.730
B	7.50	7.74	0.295	0.305
C	3.26	3.75	0.128	0.148
D	0.39	0.50	0.015	0.020
E	2.24	2.48	0.088	0.098
F	0.67	0.81	0.026	0.032
G	1.27 BSC		0.050 BSC	
H	— 0.50		— 0.020	
K	0.89	1.14	0.035	0.045
L	0.64 BSC		0.025 BSC	
M	0°	10°	0°	10°
N	0.76	1.14	0.030	0.045
P	8.38	8.64	0.330	0.340
R	6.60	6.86	0.260	0.270
S	0.77	1.01	0.030	0.040

## ORDERING INFORMATION (Order by Full Part Number)

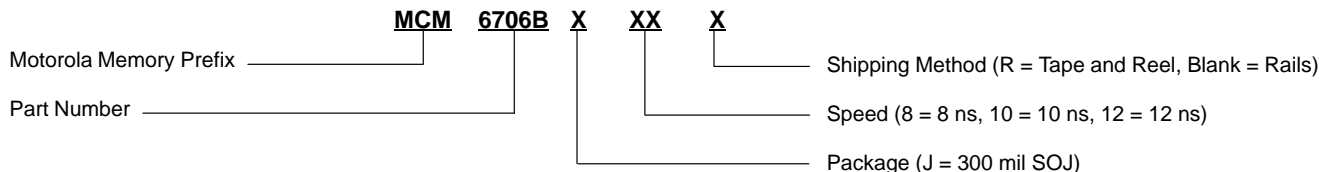

Full Part Numbers — MCM6706BJ8      MCM6706BJ8R  
 MCM6706BJ10      MCM6706BJ10R  
 MCM6706BJ12      MCM6706BJ12R

Motorola reserves the right to make changes without further notice to any products herein. Motorola makes no warranty, representation or guarantee regarding the suitability of its products for any particular purpose, nor does Motorola assume any liability arising out of the application or use of any product or circuit, and specifically disclaims any and all liability, including without limitation consequential or incidental damages. "Typical" parameters which may be provided in Motorola data sheets and/or specifications can and do vary in different applications and actual performance may vary over time. All operating parameters, including "Typicals" must be validated for each customer application by customer's technical experts. Motorola does not convey any license under its patent rights nor the rights of others. Motorola products are not designed, intended, or authorized for use as components in systems intended for surgical implant into the body, or other applications intended to support or sustain life, or for any other application in which the failure of the Motorola product could create a situation where personal injury or death may occur. Should Buyer purchase or use Motorola products for any such unintended or unauthorized application, Buyer shall indemnify and hold Motorola and its officers, employees, subsidiaries, affiliates, and distributors harmless against all claims, costs, damages, and expenses, and reasonable attorney fees arising out of, directly or indirectly, any claim of personal injury or death associated with such unintended or unauthorized use, even if such claim alleges that Motorola was negligent regarding the design or manufacture of the part. Motorola and are registered trademarks of Motorola, Inc. Motorola, Inc. is an Equal Opportunity/Affirmative Action Employer.

Mfax is a trademark of Motorola, Inc.

### How to reach us:

**USA/EUROPE/Locations Not Listed:** Motorola Literature Distribution;  
 P.O. Box 5405, Denver, Colorado 80217. 303-675-2140 or 1-800-441-2447

**JAPAN:** Nippon Motorola Ltd.: SPD, Strategic Planning Office, 4-32-1,  
 Nishi-Gotanda, Shinagawa-ku, Tokyo 141, Japan. 81-3-5487-8488

**Mfax™:** RMFAX0@email.sps.mot.com – TOUCHTONE 602-244-6609  
 – US & Canada ONLY 1-800-774-1848

**ASIA/PACIFIC:** Motorola Semiconductors H.K. Ltd.; 8B Tai Ping Industrial Park,  
 51 Ting Kok Road, Tai Po, N.T., Hong Kong. 852-26629298

**INTERNET:** <http://motorola.com/sps>

