

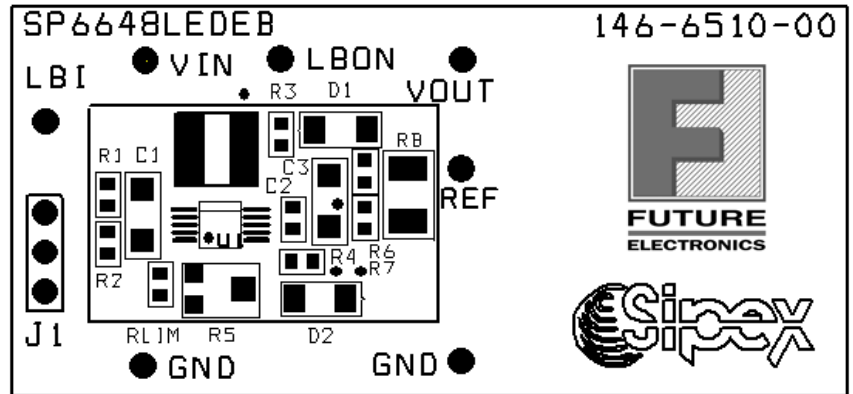

SP6648LED Evaluation Board Manual

- Easy evaluation for SP6648 performance of driving 1W LumiLED.
- Plug & Light ON
- Self Protection
- Programmable Inductor Peak Current
- High Efficiency: up to 94%
- μ SOIC Package & SMT components for small, low profile Power Supply



DESCRIPTION AND BOARD SCHEMATIC

The **SP6648LED Evaluation Board** is designed to help the user evaluate the performance of the SP6648 for use as a dual cell input to drive a 1W LumiLED. The evaluation board is a completely assembled and tested surface mount board which provides easy probe access points to all SP6648 inputs and outputs so that the user can quickly connect and measure electrical characteristics and waveforms.

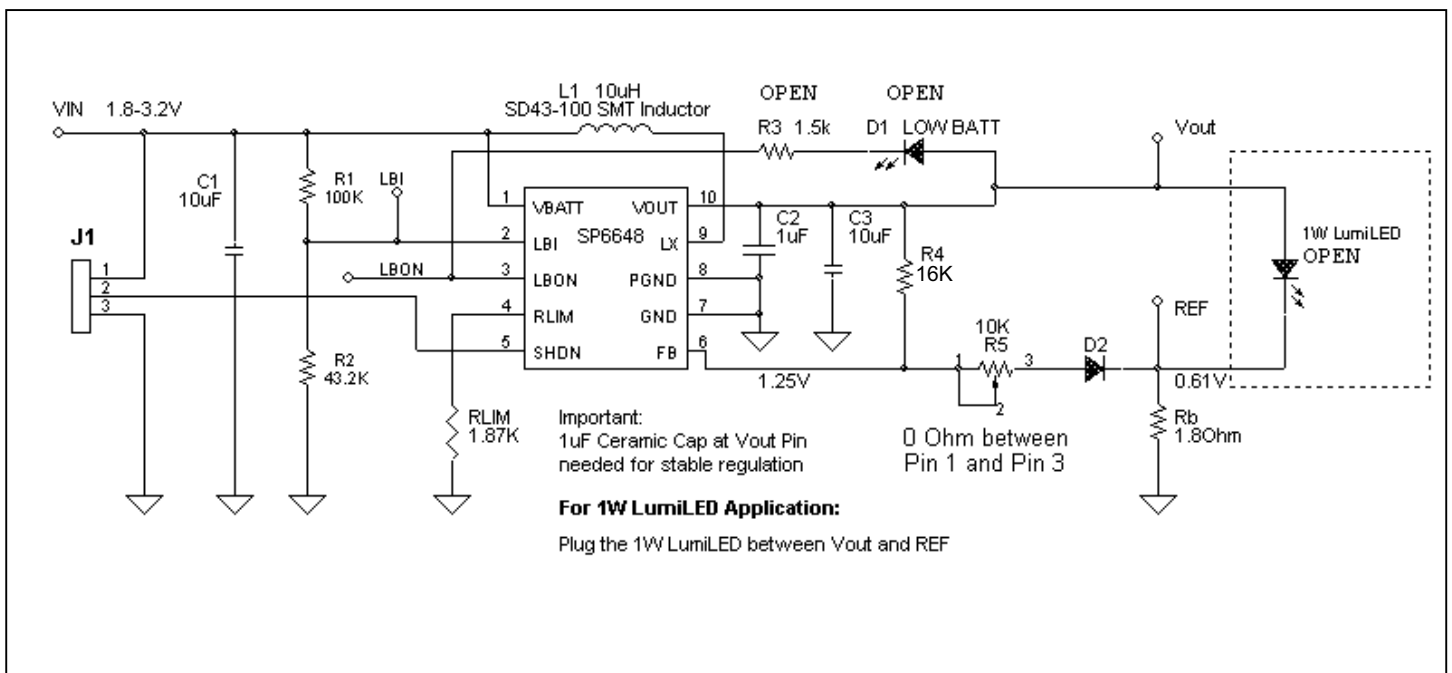

USING THE EVALUATION BOARD

1) Powering Up the SP6648LED Circuit

The SP6648LED Evaluation Board can be powered from inputs from a +1.8V to +3.2V power supply or from 2 alkaline cells. Connect with short leads directly to the “VIN” and “GND” posts. Plug the 1W LumiLED between the “VOUT” and “REF” posts. Unlike other boost regulators, the part has self-protection feature. It will not be damaged when the output is open as long as there is a low resistance from FB to GND. As shown in Figures 1 and 2, if the board is powered up before the LumiLED is plugged in, the circuit will bring the Feedback pin to 0V and the SP6648 has a feature to set the output voltage to be 3.3V. Once the LumiLED is plugged in, the Feedback pin will go up to 1.25V and begin to regulate. The output voltage will go from 3.3V to 3.68V ($=V_F+0.61V$) accordingly (as shown in Fig. 1), where V_F is the forward voltage of the LumiLED. When the LumiLED is open, the Feedback pin voltage will go to 0V and the output voltage will go to 3.3V which will protect the part (as shown in Fig 2).

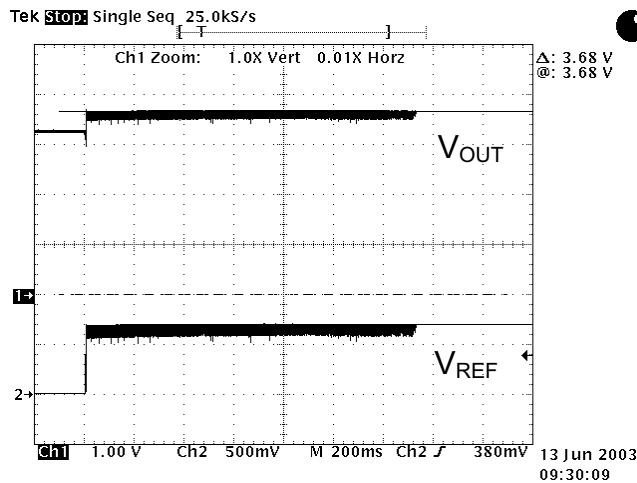

Fig 1. Plug in the LumiLED

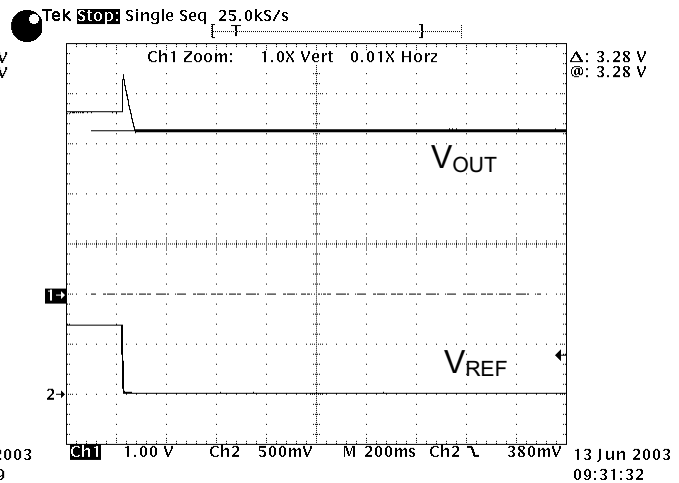

Fig. 2. Unplug the LumiLED

2) Using the J1 Jumper: Enabling the SP6648 Output and using the Shutdown Mode

The SP6648 output will be enabled if the J1 Jumper is in the top or pin 1 to 2 position. If J1 is in the pin 2 to 3 position, the Shutdown pin is brought to GND, which puts the SP6648 in the low quiescent Shutdown Mode.

3) Selecting the Bias Resistor

In the white LEDs application, the SP6648 is generally programmed as a current source. The bias resistor is used to set the operating current of the white LED as equation

$$R_b = \frac{V_{REF}}{I_F}$$

where V_{REF} is around 0.61V, I_F is the operating current of the Lumiled. To set the operating current to be about 350mA, R_b is selected as 1.8 Ohm as shown in the schematic.

4) Vout Programming

The SP6648 can be programmed as either a voltage source or a current source. To program the SP6648 as voltage source, the SP6648 requires 2 feedback resistors R_6 & R_7 to control the output voltage. To set V_{out} in the voltage mode, use the equation:

$$R_6 = \left(\frac{V_{out}}{0.61} - 1 \right) \cdot R_7$$

5) Using the R_{lim} Function

The peak inductor current, I_{PEAK} , is programmed externally by the R_{LIM} resistor connected between the RLIM pin and GND. The peak inductor current is defined by:

$$I_{PEAK} = 1400/R_{LIM}$$

The SP6648 datasheet specifications for R_{LIM} give a range of 1.87K to 4K ohms. Using the I_{PEAK} equation above gives an I_{PEAK} range of 350 to 750mA.

The saturation current specified for the inductor needs to be greater than the peak current to avoid saturating the inductor, which would result in a loss in efficiency and could damage the inductor. The SP6648 evaluation board uses a R_{lim} value of 1.87K for an $I_{peak} = 750mA$ to allow the circuit to deliver up to 180mA for 1.3V input and 400mA for 2.6V input. Other values could be selected using the above relationships.

6) Using the LBON - Low Battery Output Function

The SP6648 will regulate the output current until the input battery is completely discharged. To provide an early low battery warning, the Low Battery Output function of the SP6648 switching regulator can be used. LBON is programmed externally by the R_1 and R_2 resistor divider connected between VIN, the LBI input pin and GND. When the LBI comparator falling threshold of 0.61V is reached, D1 switches on, indicating low battery condition. Low battery detect trip point can be calculated by the following formula:

$$V_{LOWBAT} = 0.61 \cdot \frac{R_1 + R_2}{R_2}$$

The SP6648 evaluation board R_1 & R_2 resistors have been set to trip for a falling battery threshold of about 2.0V. Using this relationship, other low battery threshold values can be set by the user.

7) Brightness Control

One approach to control LED brightness is to apply a PWM signal to the SHDN input of the SP6648. In this case, the output current will be equal to the product of 350mA and the average duty cycle at the SHDN pin. An additional 10K potentiometer (R_5) may also be used for dimming LED. LED current is varied by the potentiometer between almost zero and full 350mA.

POWER SUPPLY DATA

For the standard evaluation board, The efficiency curve is shown in the figure below.

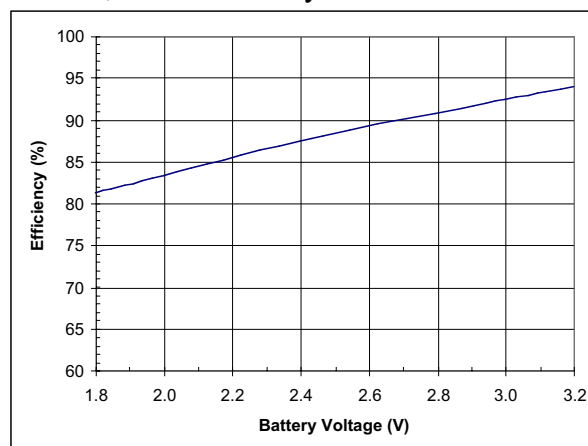

Fig.3 Efficiency curve of the SP6648LED evaluation board

EVALUATION BOARD LAYOUT

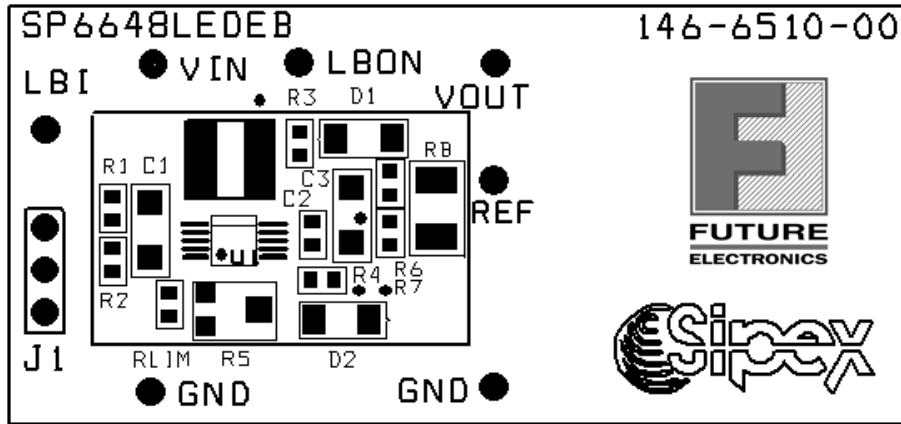

FIGURE 1: SP6648LEDEB COMPONENT PLACEMENT

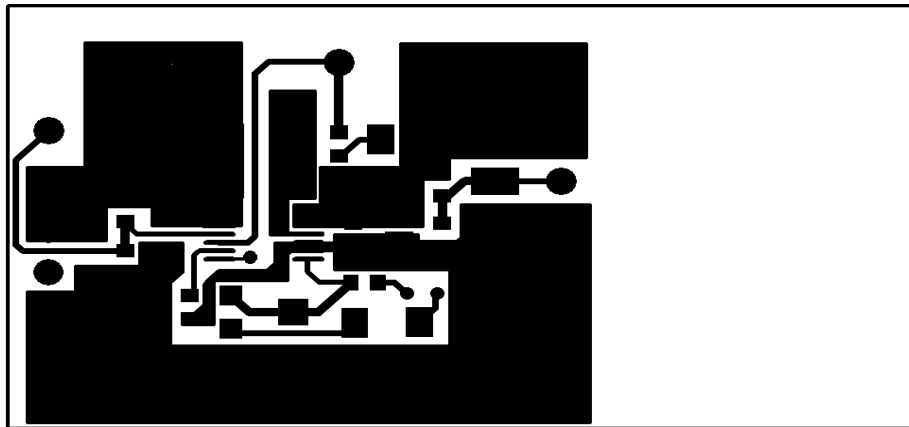

FIGURE 2: SP6648LEDEB PC LAYOUT TOP SIDE

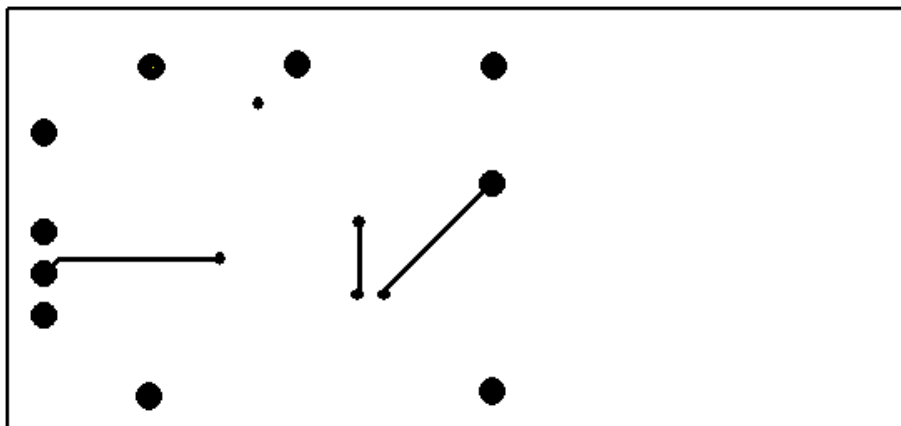

FIGURE 3: SP6648LEDEB PC LAYOUT BOTTOM SIDE

TABLE1: SP6648LEDEB LIST OF MATERIALS

SP6648LED Evaluation Board List of Materials						
Ref. Des.	Qty.	Manufacturer	Part Number	Layout Size LxWxH	Component	Vendor
	1	Sipex Corp.	146-6510-00	1"x2.14"	SP6648LED Eval PC Board	Future 888-589-3662
U1	1	Sipex Corp.	SP6648EU	MSOP-10	10 PIN High Efficiency Boost Regulator	Future 888-589-3662
C1,C3	2	TDK Corp	TDKC3216X5R0J106K	1206	10uF/6.3V/X5R/10% Ceramic	Future 888-589-3662
C2	1	TDK Corp	TDKC1608X5R0J105K	603	1uF/6.3V/X5R/10% Ceramic	Future 888-589-3662
L1	1	Sumida	CD43-100	4x4.5x3.2mm	10uH, 1.04A, 0.18 Ohm, SM inductor	Future 888-589-3662
R1	1	Rohm	MCR03EZPFX1003	603	100K 1/16W 1% 0603 SM	Future 888-589-3662
R2	1	Rohm	MCR03EZPFX4322	603	43.2K 1/16W 1% 0603 SM	Future 888-589-3662
R3	1	Rohm	MCR03EZPFX1501	603	Open	Future 888-589-3662
R4	1	Rohm	MCR03EZPFX1622	603	16.2K 1/16W 1% 0603 SM	Future 888-589-3662
R5	1	Rohm	MVR32HXBRN103	3x3.6x1.3mm	0 Ohm between pin 1 and pin 3	Future 888-589-3662
R6	1	Rohm			Open	Future 888-589-3662
R7	1	Rohm			Open	Future 888-589-3662
Rlim	1	Rohm	MCR03EZPFX1871	603	1.87K 1/16W 1% 0603 SM	Future 888-589-3662
Rb	1	Rohm	MCR25JZHJ1R8	1210	1.8 Ohm 1/4W 5% 1210 SM	Future 888-589-3662
D1	1	Stanley	BR1101W-TR	3x1.5x1.5mm	Open	Future 888-589-3662
D2	1	Diode Inc.	1N4148W-7	SOD-123	75V 150mA SM Diode	Future 888-589-3662
TP	7	Mill-Max	0300-115-01-4701100	.042 Dia	Test Point Female Pin	Future 888-589-3662
J1	1	Sullins	PTC36SAAN	.23x.12	2-Pin Header	Future 888-589-3662

ORDERING INFORMATION

Model	Temperature Range	Package Type
SP6648LEDEB.....	-40°C to +85°C.....	SP6648LED Evaluation Board
SP6648EU.....	-40°C to +85°C.....	10-pin μSOIC