

*Advance Information*

NTSC

Digital Video Encoder

HCMOS Technology

The MC44722 and MC44723 are Digital Video Encoders (DVE). They convert ITU-601/656 standard 4:2:2 Bit-Parallel data into analog composite video, S-Video or Y/Cb/Cr in PAL and NTSC formats. They accept the multiplexed ((CB,Y,CR)Y) signals from digital sources such as MPEG decoders and can act as a sync generator master. All video processing is done digitally and requires no external adjustment. Specifically designed for digital satellite, digital cable decoders and multimedia terminals.

- World Wide Operation (PAL-BDGHI, PAL-N,PAL-M, NTSC-M)
- SMPTE 170M / ITU - R 624 composite video output
- Programmable Color Sub-carrier Frequencies
- **Analog Horizontal, Vertical, Frame or Composite Sync** Outputs
- Sync Extraction From Digital Input Data (SAV, EAV)
- Sync Polarity and Horizontal Phase Control
- Master or Slave Sync (**H/Vsync, H/Fsync, ITU-R656 slave**) Operation
- Interlaced or Non-Interlaced Support
- 625/50 or 525/60 ITU-601/656 **8-bit** ((CB,Y,CR)Y) Digital Input
- Luma 2X / Chroma 4X Oversampling Filtering
- **External VBI Information Data Input** (such as TeleText Information Data)
- **CVBS / YS / CS** or **Y / Cb / Cr** Analog Outputs Through **10-bit** DACs
- Easily programmed via Serial Bus (**I2C** or **SPI** Bus)
- **2 Hardware I2C Chip Addresses**
- **Closed-Caption** and **CGMS** Information data Insertion
- **MACROVISION ver. 7.01** Anti-Copy Signal Insertion
(MC44722 Only support NTSC mode)
- On Chip **Color - bar** Generator
- **+3.3V** Power Supply or **+3.3V(Digital)/+5V(Analog)** Power Supply
- Pin Compatible with **MC44720FT**

The MC44722 device is protected by U.S. patent number 4,631,603,4,577,216 and 4,819,098 and other intellectual property rights. The use of Macrovision's copy protection technology in the device must be authorized by Macrovision and is intended for home and other limited pay-per-view uses only, unless otherwise authorized in writing by Macrovision. Reverse engineering or disassembly is prohibited.

MC44722

MC44723

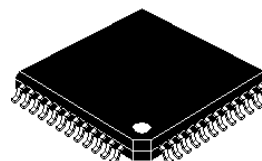

FT SUFFIX
48 QFP
(0.8mm Pitch)



[Pin Assignment]

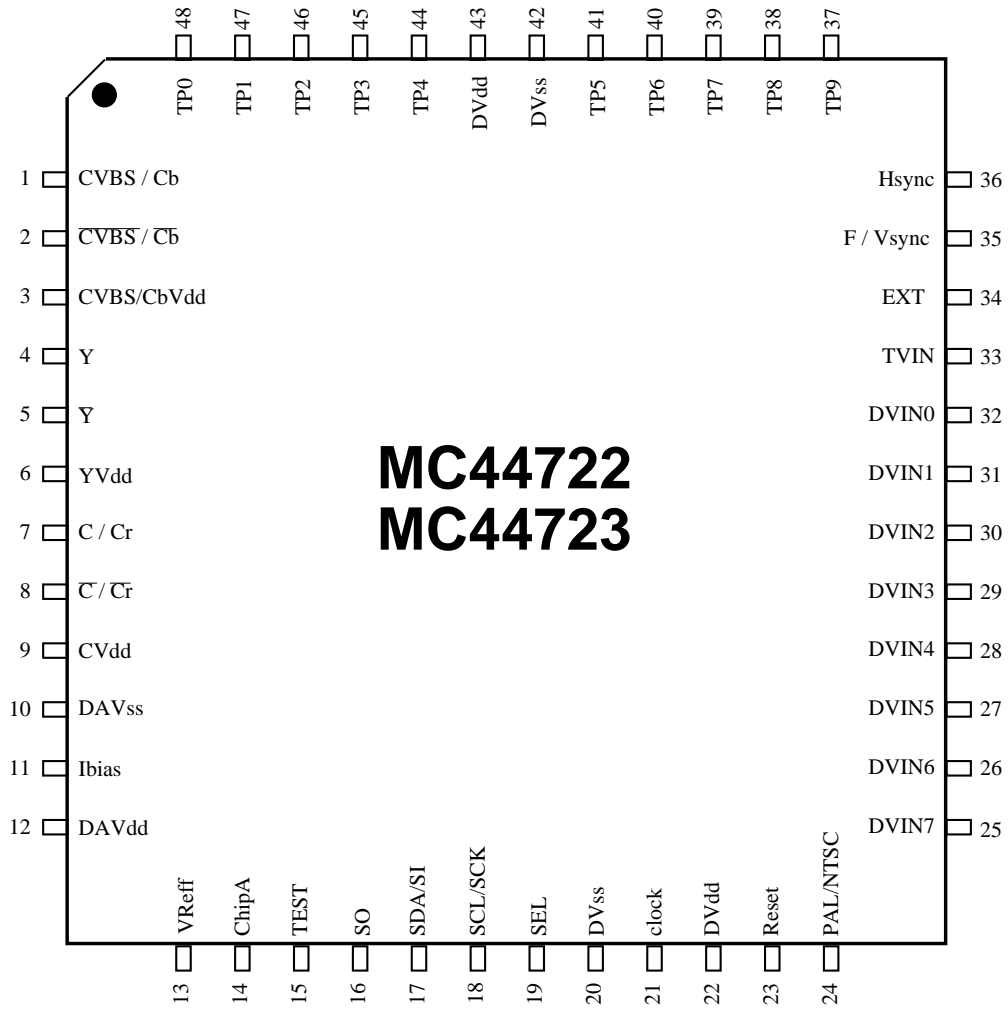

**[Pin Descriptions]**

PIN	NAME	I/O	DESCRIPTIONS
1	CVBS / Cb	O	Analog composite video signal output or Cb signal output current drive(positive)
2	CVBS /Cb	O	Analog composite video signal output or Cb signal output current drive(negative)
3	CVBS/CbVdd		Power Supply for CVBS / Cb DAC circuit
4	Y	O	Analog luminance signal output current drive(positive)
5	Y	O	Analog luminance signal output current drive(negative)
6	YVdd		Power Supply for Y DAC circuit
7	C/Cr	O	Analog chrominance signal output or Cr signal output current drive(positive)
8	C/Cr	O	Analog chrominance signal output or Cr signal output current drive(negative)
9	C/CrVdd		Power Supply for C / Cr DAC circuit
10	DAVss		Ground for DAC circuit
11	Ibias	O	Reference current for the 3 DACs
12	DAVdd		Power Supply for DAC circuit
13	VReff		Reference full scale voltage for the 3 DACs
14	ChipA		I2C chip address select { 0 : 42(hex)/43(hex) 1 : 1C(hex) /1D(hex) }
15	TEST	I	TEST pin(Ground)
16	SO	z(O)	If SPI mode, serial data output / If I2C mode, connect to Ground
17	SDA/SI	I/O(I)	Serial data input, Open drain output / If SPI mode, serial data input
18	SCL/SCK	I	Serial clock
19	SEL	(I)	Connect to Ground / If SPI mode, this pin is chip select
20	DVss		Ground for Digital circuit
21	CLOCK	I	27MHz clock input
22	DVdd		Power Supply for Digital circuit
23	Reset	I	Reset signal, active LOW
24	PAL/NTSC	I	NTSC/PAL select . This pin active only Reset time. (NTSC : Low PAL : High)
25~32	DVIN7~0	I	8-bit Multiplexed Y/Cr/Cb 4:2:2 data(CCIR Rec656) input(1)
33	TVIN	I	TEST data input
34	EXT	I/O	Csync/Frame sync output or external VBI information input
35	F/Vsync	I/O	Frame sync or Vertical sync input/output
36	Hsync	I/O	Horizontal sync input/output
37	TP9	I/O	for D/A converter test
38	TP8	I/O	MUX switch in 8-bit Multiplexed Y/Cr/Cb 4:2:2 data(CCIR Rec656) input mode, or Test data input/output
39~41	TP7~5	I/O	8-bit Multiplexed 4:2:2 data(CCIR Rec656/601) input(2), or Multiplexed Cr/Cb data (CCIR Rec656/601) input in 16-bit input mode (MSB : TP7), or Test data input/output
42	DVss		Ground for Digital circuit
43	DVdd		Power Supply for Digital circuit
44~48	TP4~0	I/O	8-bit Multiplexed 4:2:2 data(CCIR Rec656/601) input(2), or Multiplexed Cr/Cb data (CCIR Rec656/601) input in 16-bit input mode (LSB : TP0), or Test data input/output



[Block Diagram]

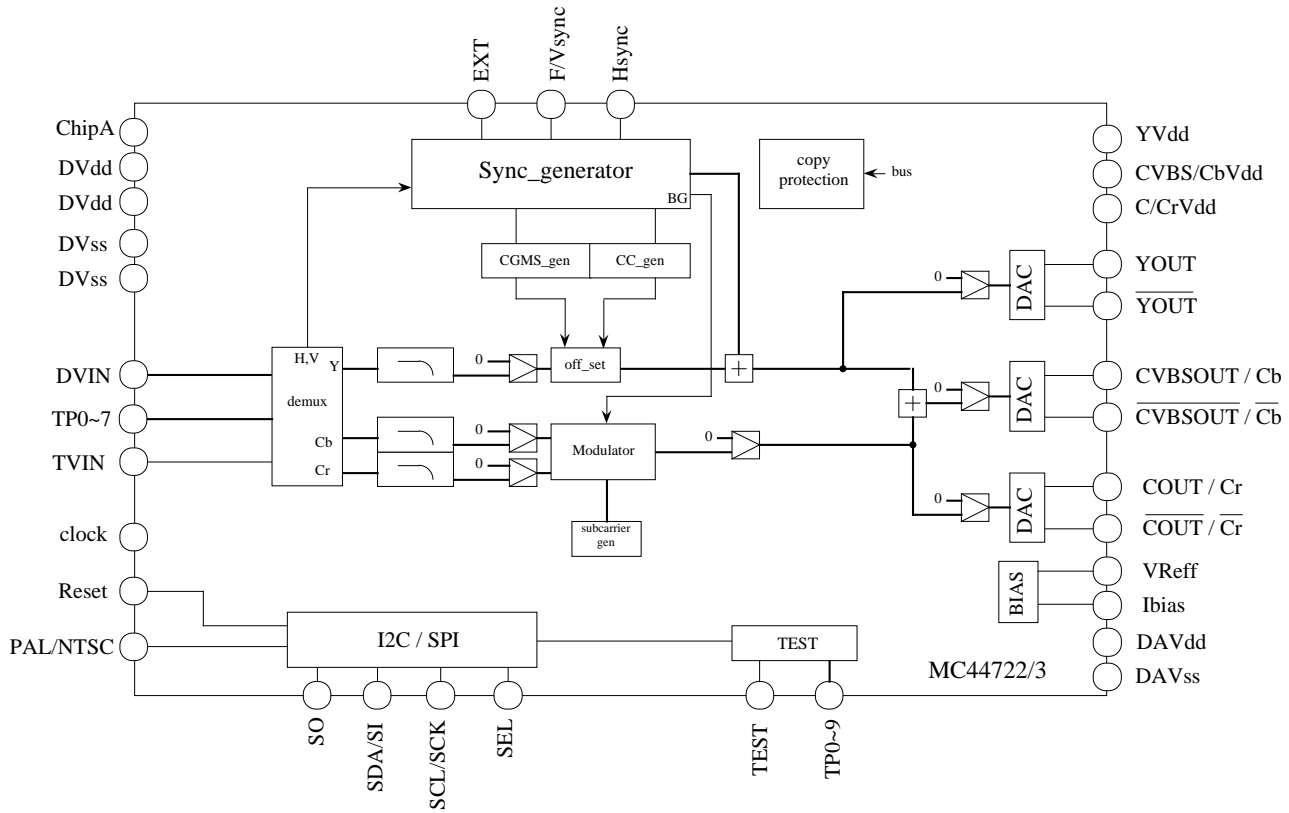

I2C/SPI chip-address 42/43(hex)
 1C/1D(hex)



[Function Descriptions]

Clock

27.0Mhz is necessary. This signal on the clock pin needs to be active before the reset pin is de-asserted.
(see figures 1 and 2)

Reset Procedure

RESET is a level sensitive input pin. Driving the RESET pin low causes a DVE reset. The 27Mhz DVE clock signal must be active before RESET is released. De-asserting reset will latch the status of the PAL/NTSC, TVIN and SEL pins.

The PAL/NTSC pin determines the default values for the DVE control registers. The default register values have been chosen so that standard PAL or NTSC video will appear at the DAC outputs immediately when a valid input digital video data stream is present.

The value on the SEL pins determine the default serial communication mode. If Low, the DVE use I2C bus operation. If High, the DVE use 4-wire SPI operation.

After reset, the VBI signals (Closed-Caption and CGMS) are disabled.

(see page --- for sub-address register descriptions.)

Fig 1 : DVIN Data Input Timing

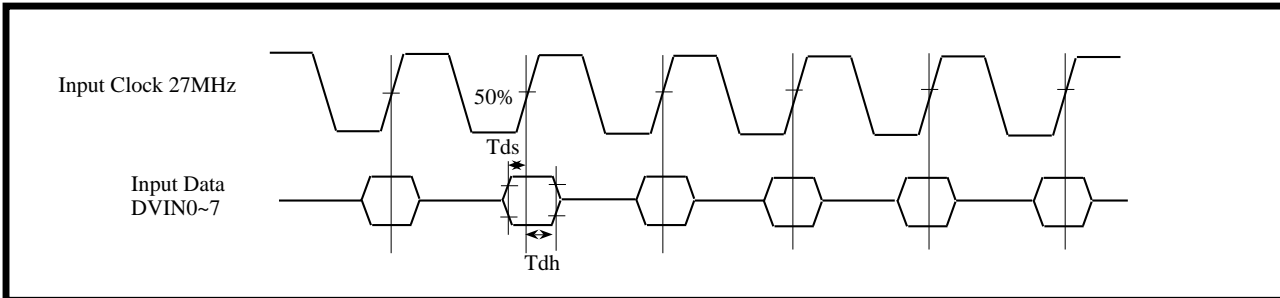
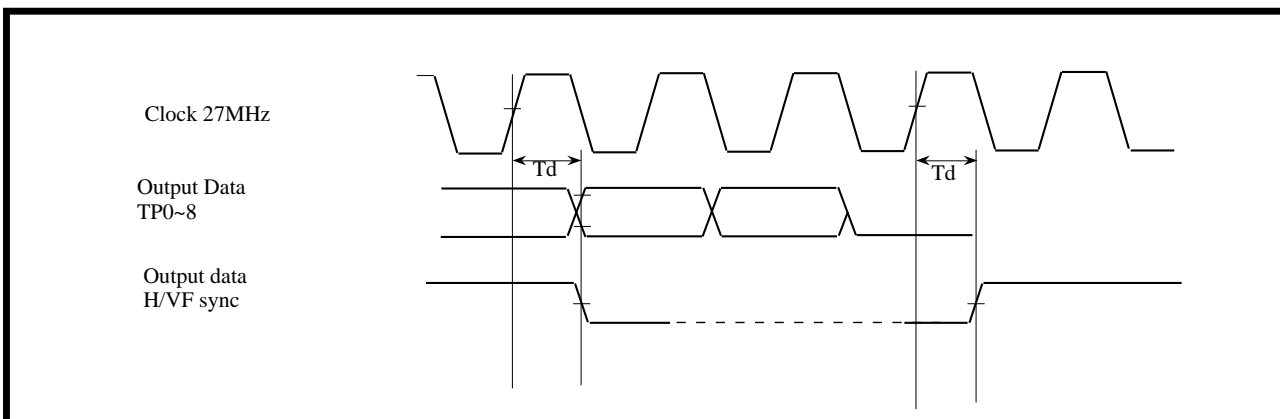

Fig 2 : Sync Data Output Timing





Input Data Format

The input digital video is in accord with the ITU-R Rec.656 and SMPTE 125M standards. It is two 8-bit or 16-bit multiplexed 4:2:2 ((CB,Y,CR)Y) data stream. Samples are latched on the rising edge of the clock signal. Data is input on pins DVIN[7 : 0] and TP[8 : 1] (see figures 3 and 4 for sub-address register descriptions.)

Video Timing / Sync Generator

The DVE outputs PAL-B,D,G,H,I, PAL-N, PAL-M or NTSC-M standard video signals.

The DVE sync generator can be operated in two modes, master or slave.

In master mode, the DVE generates all the correct Horizontal and Vertical or Frame sync signals internally, or it is output Csync signal through the EXT pin(C/Fsync).

In slave mode, the DVE derives the sync signals from the Bit-Parallel input data stream Start Active Video (SAV) and End Active Video (EAV) data packet information. Sync signals are output on the Hsync and F/Vsync or EXT pins and can be programmed for positive or negative polarity. The phase of Hsync can also be controlled.

Also, the DVE allows more two slave modes. One is H/Vsync slave, and the other is H/Fsync slave mode.

Vertical Blanking corresponds to the following lines.

625/50 624-22 311-335 ITU-R line numbering

525/60 1-19 264-282 SMPTE line numbering

(see figures 3,4,5,6,7,8,9,10, and 11 for sub-address register descriptions.)

Fig 3 : Digital Input Timing(525/60 system) in Master Mode

70(hex){[1:0]=01}

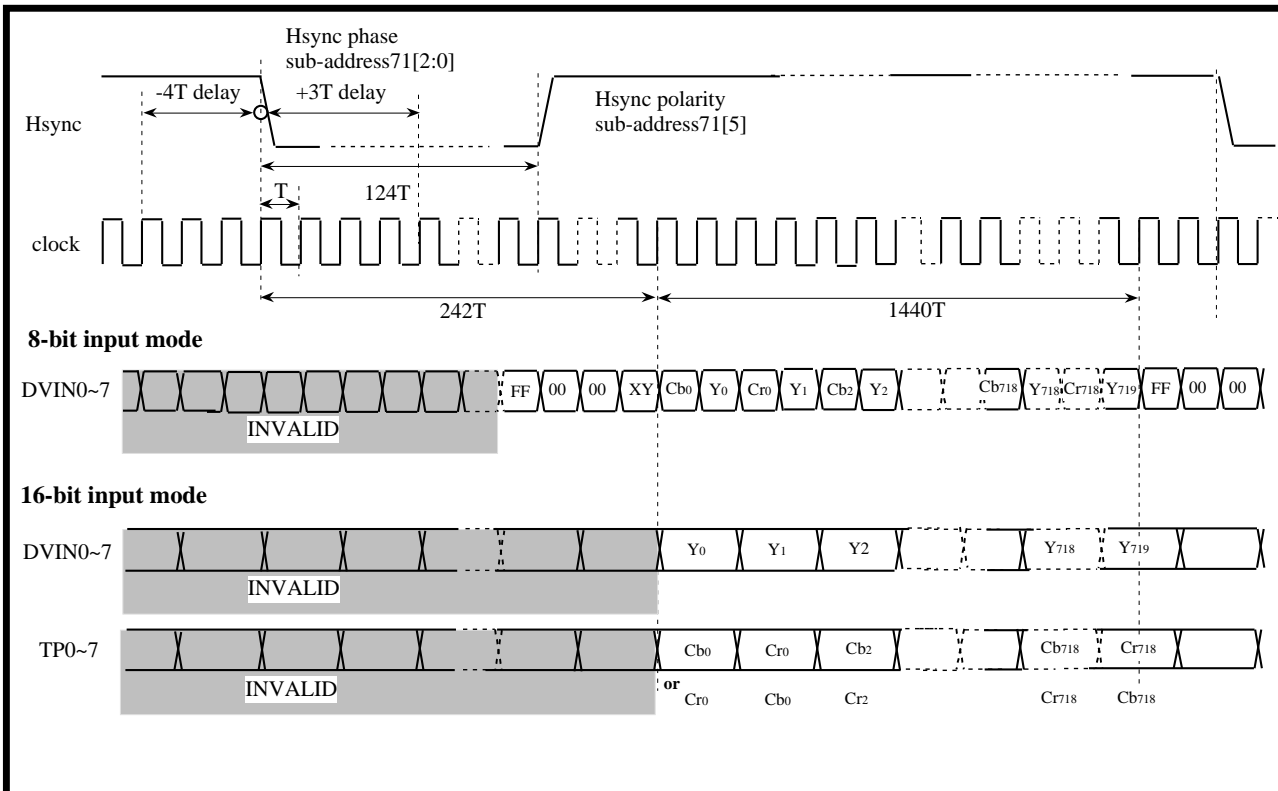



Fig 4 : Digital Input Timing(625/50 system) in Master Mode

70(hex){[1:0]=01}

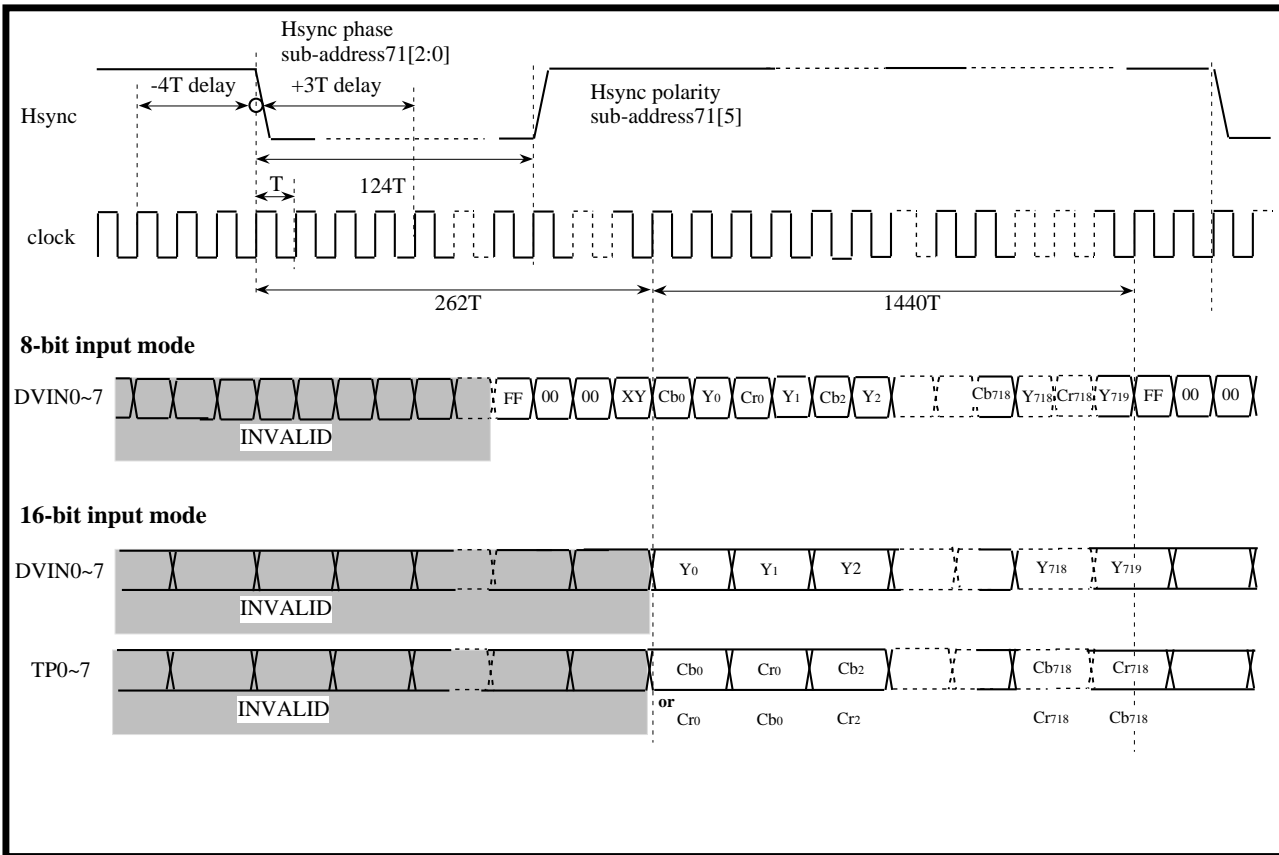

Fig 5 : Sync Timing::525/60 Interlaced System in Master Mode

sub-address71[7] =0

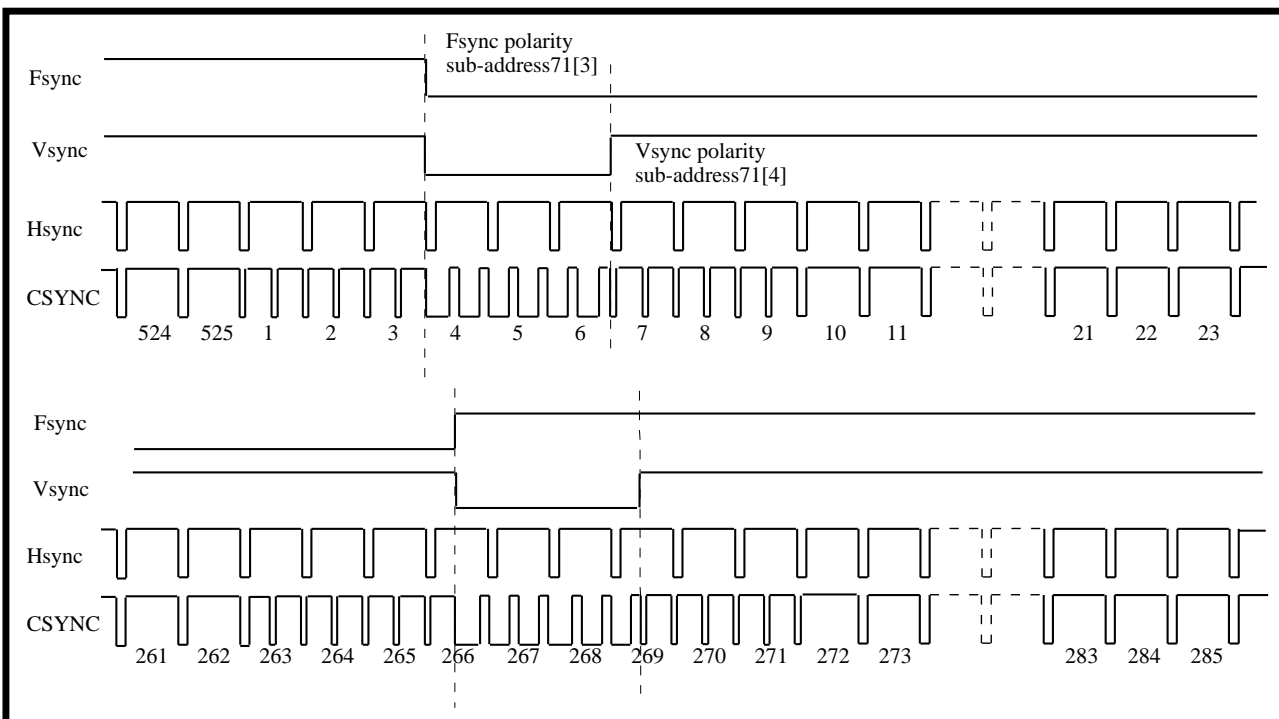



Fig 6 : Sync Timing::625/50 Interlaced System in Master Mode

sub-address71[7] =0

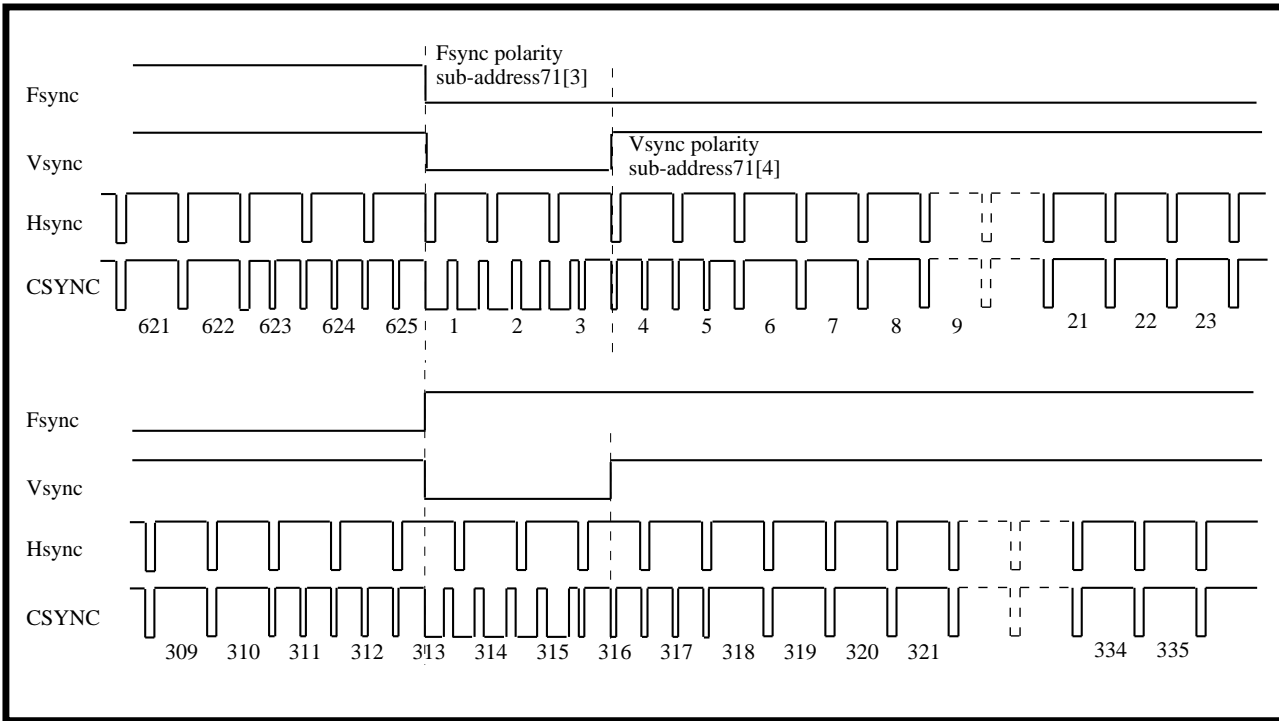

Fig 7 : Sync Timing::525/60 Non-interlaced System in Master Mode

sub-address71[7] =1

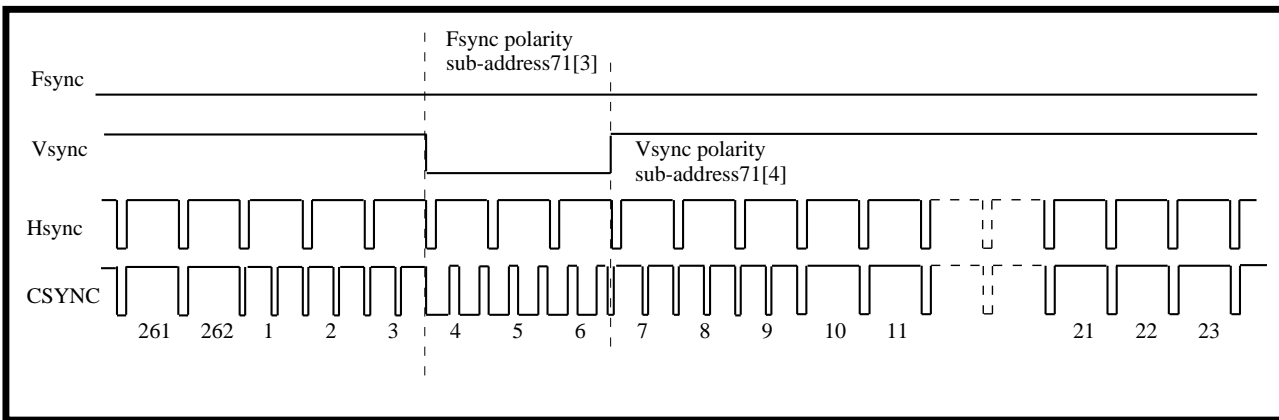

Fig 8 : Sync Timing::625/50 Non-interlaced System in Master Mode

sub-address71[7] =1

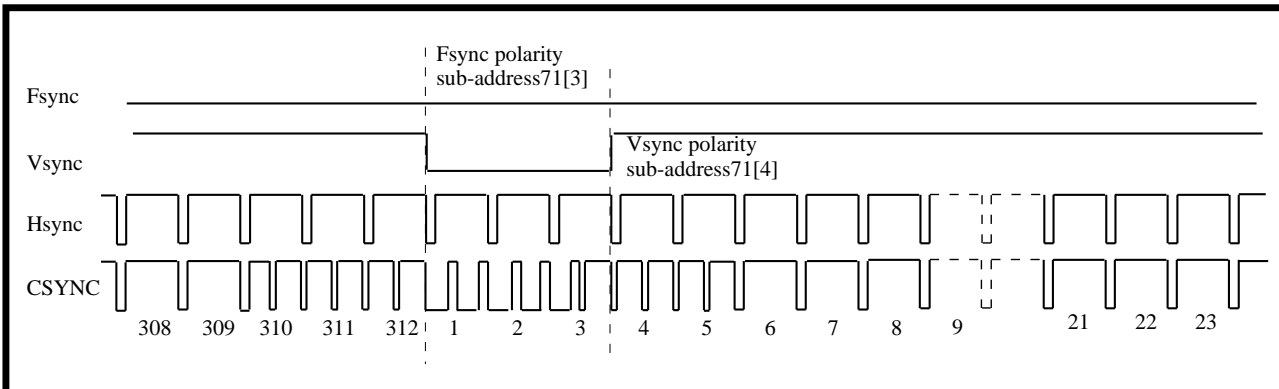



Fig 9 : Analog Sync Timing::Rise and fall

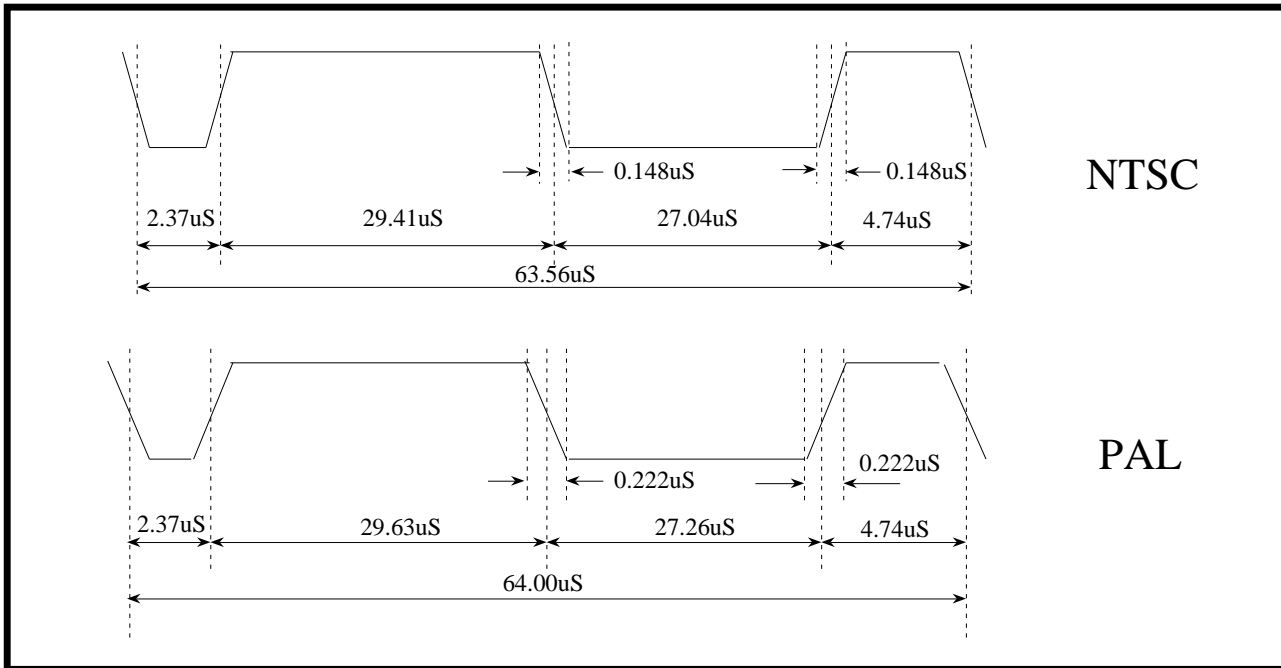

Fig 10 : Sync Timing::525/60 Interlaced System in Slave Mode

sub-address71[1:0] =10, 11

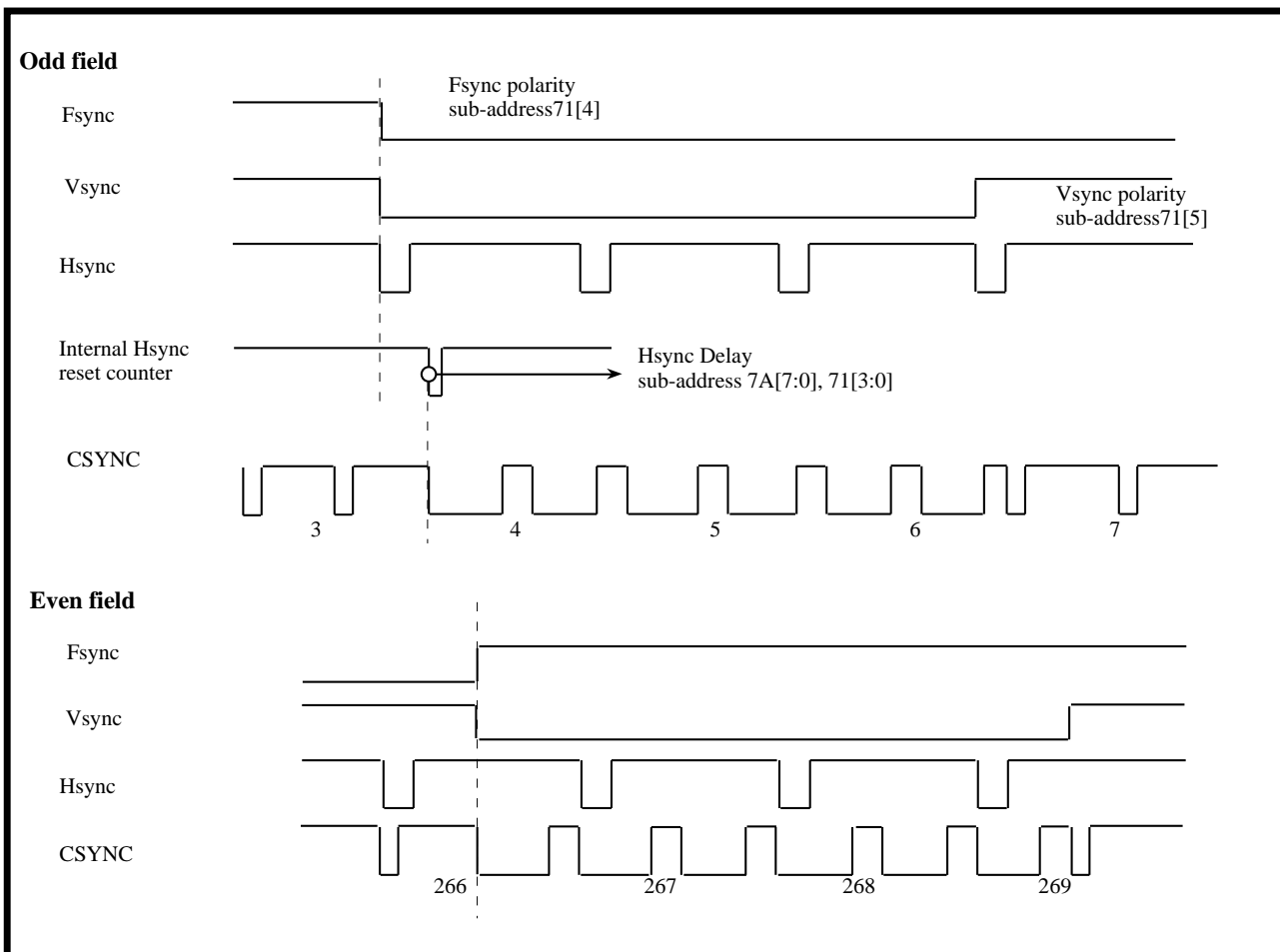
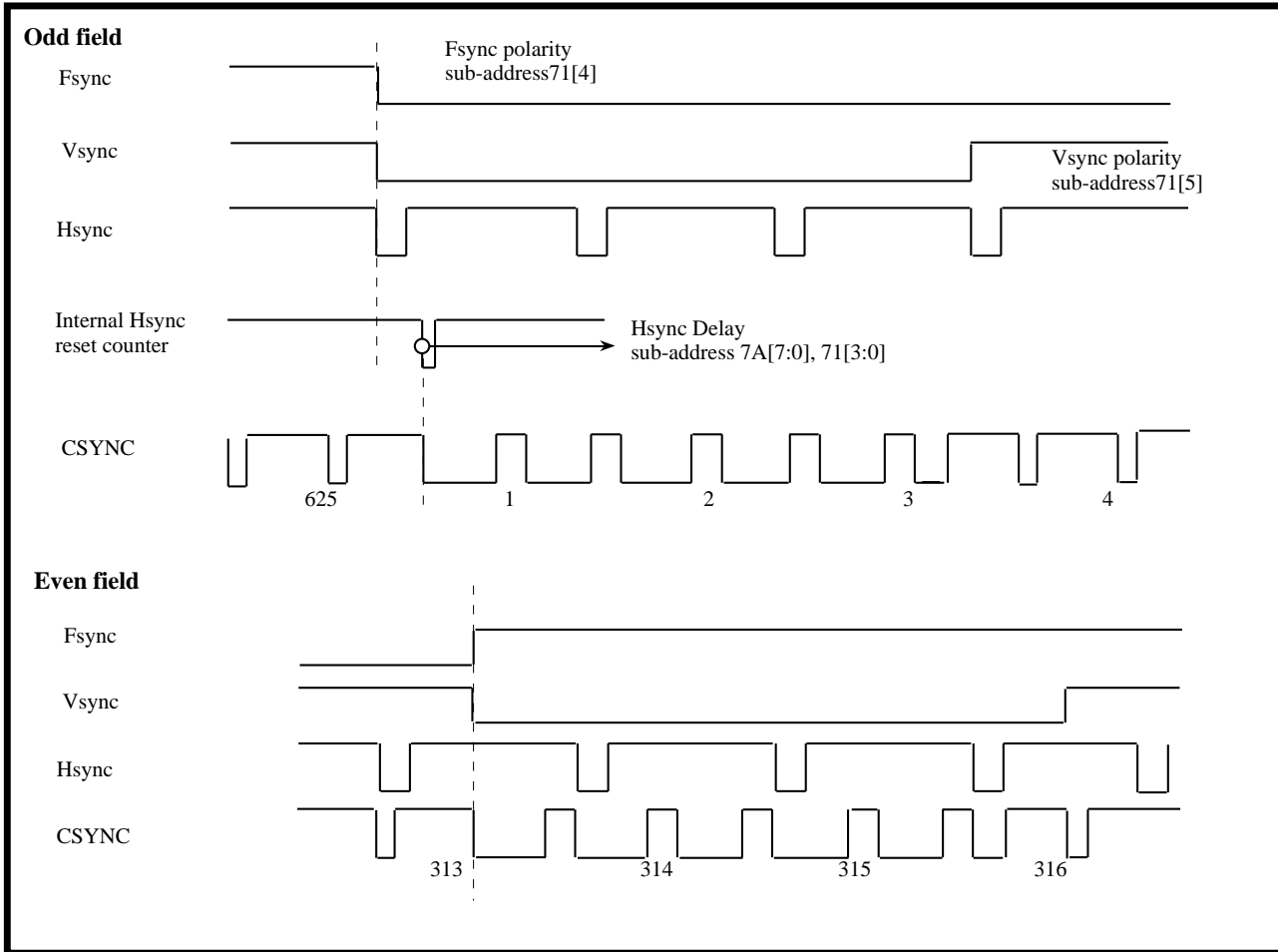



Fig 11 : Sync Timing::625/50 Interlaced System in Slave Mode

sub-address71[1:0] =10, 11





Chroma / Luma Encoding

The DVE de-multiplexes the 4:2:2 digital video data stream.

The de-multiplexed Y or Luma samples are interpolated (2X oversampled) at the clock rate. Offset compensation is then added, next any VBI signals consisting of Closed-Caption and VID are added to the appropriate lines, then finally composite sync pulses are added to the Luma signal. (see figure 12.)

De-multiplexed component color CB and CR samples are interpolated (4X oversampled) at the clock rate. Interpolating simplifies the output filter and allows more accurate encoding. The DVE generates the necessary subcarrier color frequency for PAL or NTSC encoding from the 27Mhz system clock. This color subcarrier is then modulated by the base band component color CB and CR signals to create the video Chroma signal. (see figure 13.)

A 7.5 IRE pedestal is added for the 60Hz field rate. This can be added for the 50Hz field rate through serial bus control. (see sub-address register descriptions)

CVBS and S-VIDEO or YCbCr Outputs

The internal digital video signals drive 10-bit D/A converters. Converter outputs are bi-directional current sources where the current is proportional to the digital data with reference to the IBIAS reference current. The pins CVBS/Cb, Y and C/Cr are the respective composite, Luma and Chroma or Y/Cb/Cr signal current source pins. Also, each DACs can drive **75ohm** load register.

(see "Application Diagram" and "sub-address register descriptions".)

Bias Current Gain

DACs can be switched off through serial bus control to reduce power consumption. Both outputs of unused DACs should be connected to ground through a resistor to avoid charge buildup.



Fig 12 : Luminance Output Range

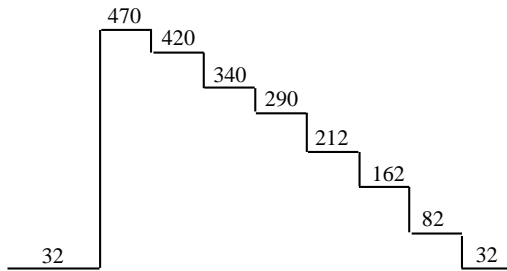

Digital Y input code(16~235)
525/60 and 625/50 system
100%amplitude,100%saturation color bar

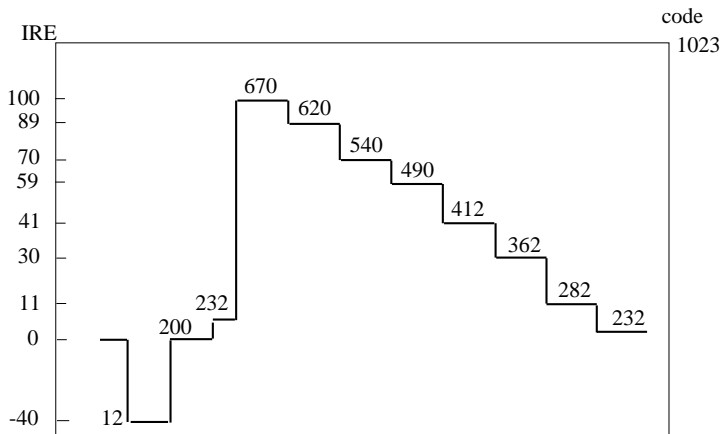

Analog Y output level(525/60 system)
100%amplitude,100%saturation color bar

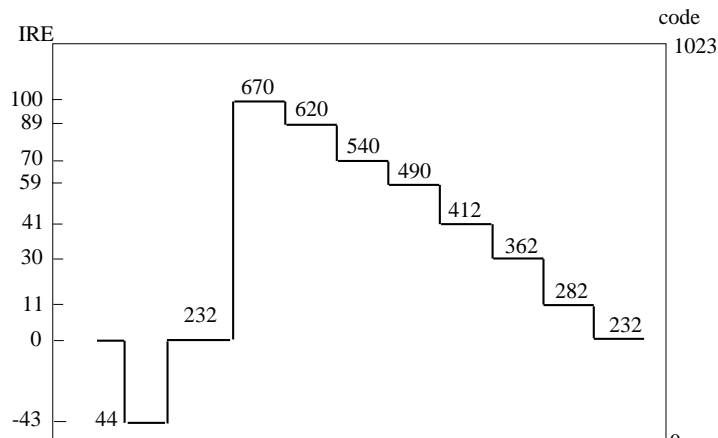

Analog Y output level(625/50 system)
100%amplitude,100%saturation color bar



Fig 13 : Chrominance Output Range

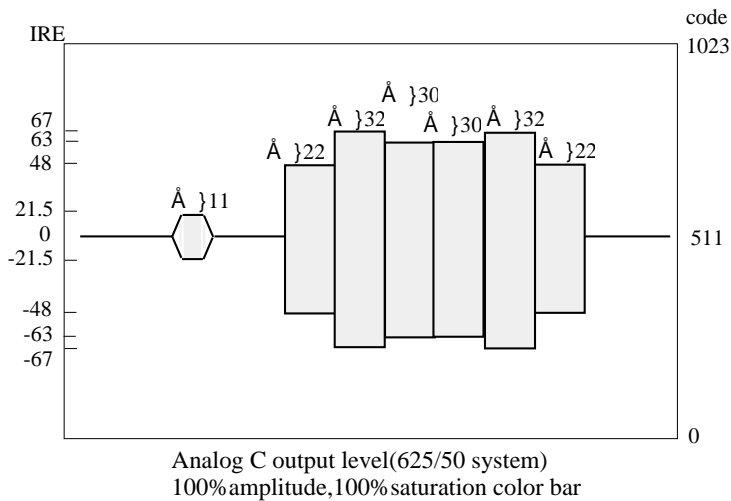
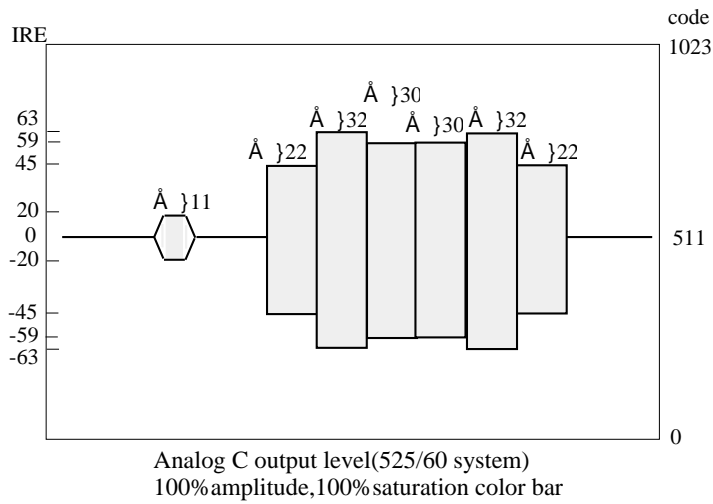
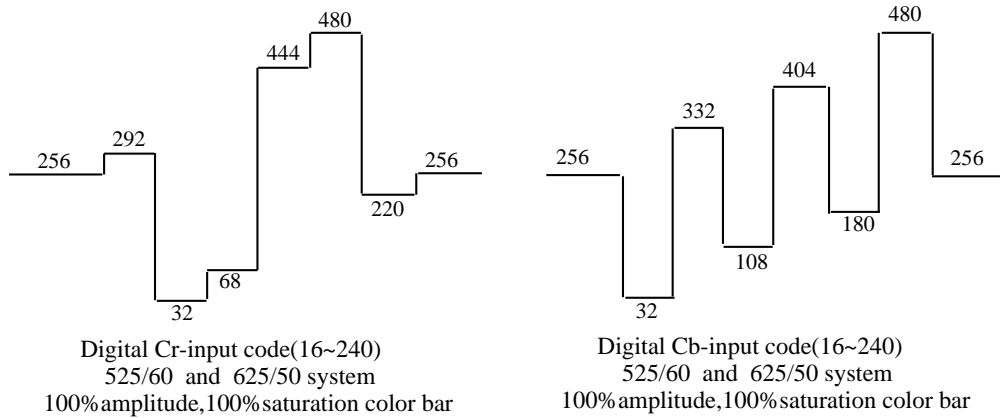



Copy Generation Management System (CGMS) Encoding

CGMS signals can be encoded by the DVE onto output video line 20 (525 / 60 for Japan).

CGMS identification signals also identify and control the TV screen presentation mode - wide screen, letterbox and or normal -16:9 or 4:3.

(see figures 16 for sub-address register descriptions.)

Closed-Caption Encoding

Closed-Captioned or Extended Data Service signals can be encoded by the DVE onto output video line 21/284 (NTSC) and line 22/335 (PAL). The CC data is input through the serial bus interface. Two 8-bit byte data pairs are encoded for each field. There are four registers for holding the data - two bytes per field. The serial data is 7bit US-ASCII MSB first, proceeded by an odd parity bit. Total 8-bits. (P-7-6-5-4-3-2-1-0)

The DVE automatically generates the required clock run in and start bit for CC encoding. (see figure 16.)

When Closed-Captioning is enabled, the system micro processor (uP) should update the CC data once each frame. The system uP should also write NULL characters when there is no CC data to encode. It is also recommended to write CC data only to the inactive frame. Field1 and Field2 data are double-buffered by the Frame sync falling edge of previous Frame, updating Frame 2 data during Frame1 display and Frame1 data during Frame2 display.

(see figures 18 for sub-address register descriptions.)



Serial Control Bus

Control of the DVE device is accomplished through the I2C-Bus or SPI serial bus.

In I2C mode, pins SDA and SCL are the respective data and clock signals. Device address can be 42(hex)/43(hex) or 1C(hex)/1D(hex). Slave address is chosen at reset by the state of the ChipA pin signal { 0 : 42(hex)/43(hex), 1 : 1C(hex)/1D(hex) }

Sub-address register read and write operations are documented in the following section.

In SPI mode, pins SO, SI, SCK and SEL are the respective data input, output, serial clock and chip select signals. Register read and write operations are documented in the following section.

MACROVISION™ Copy Protection

When the MC44722 is enabled this features in **NTSC mode**, the Luma and Chroma signals are modified according to the MACROVISION™ copy protection process for Pay Per View (PPV) applications revision 7.01 dated Sep 6th, 1996.

But this feature is **NOT supported in PAL mode**, so please do **NOT** use this features in PAL mode.

Enabling and control is through the serial control bus.

No parts will be sent to the customer until the customer provides MOTOROLA with written confirmation of a license, non-disclosure or waiver from MACROVISION™.

If your customer does NOT use this features, please recommend to use the MC44723 no-supported the copy-guard features.



Fig 14-a : I2C-BUS Interface Write operation Timing

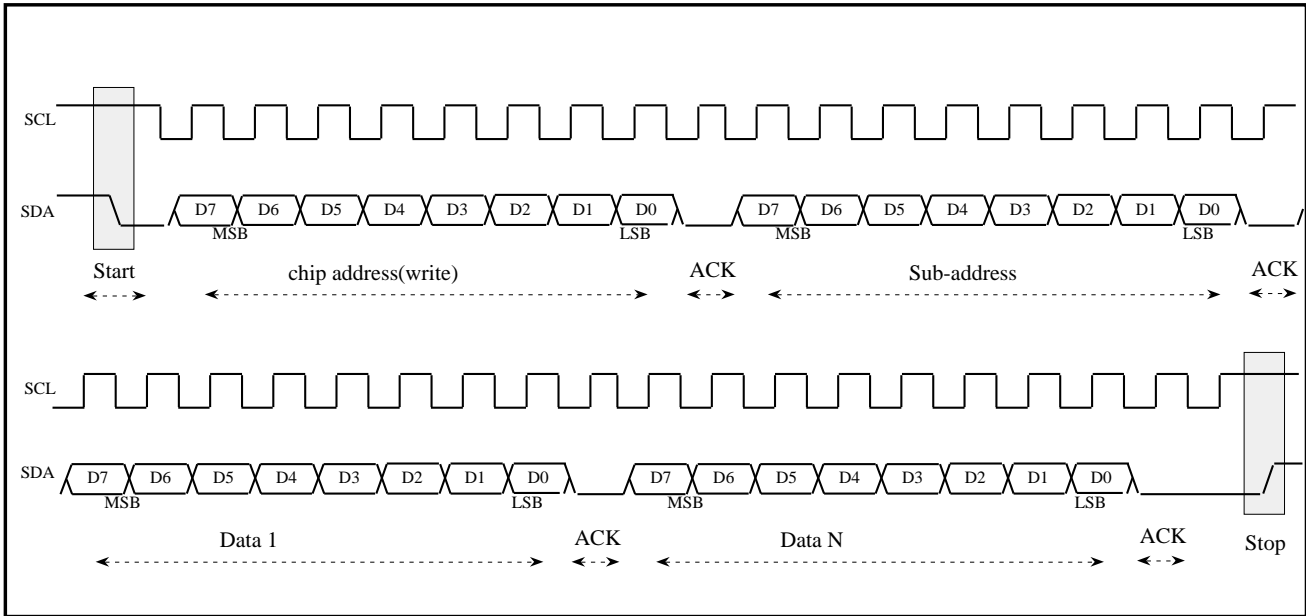

Fig 14-b : I2C-BUS Interface Read operation Timing

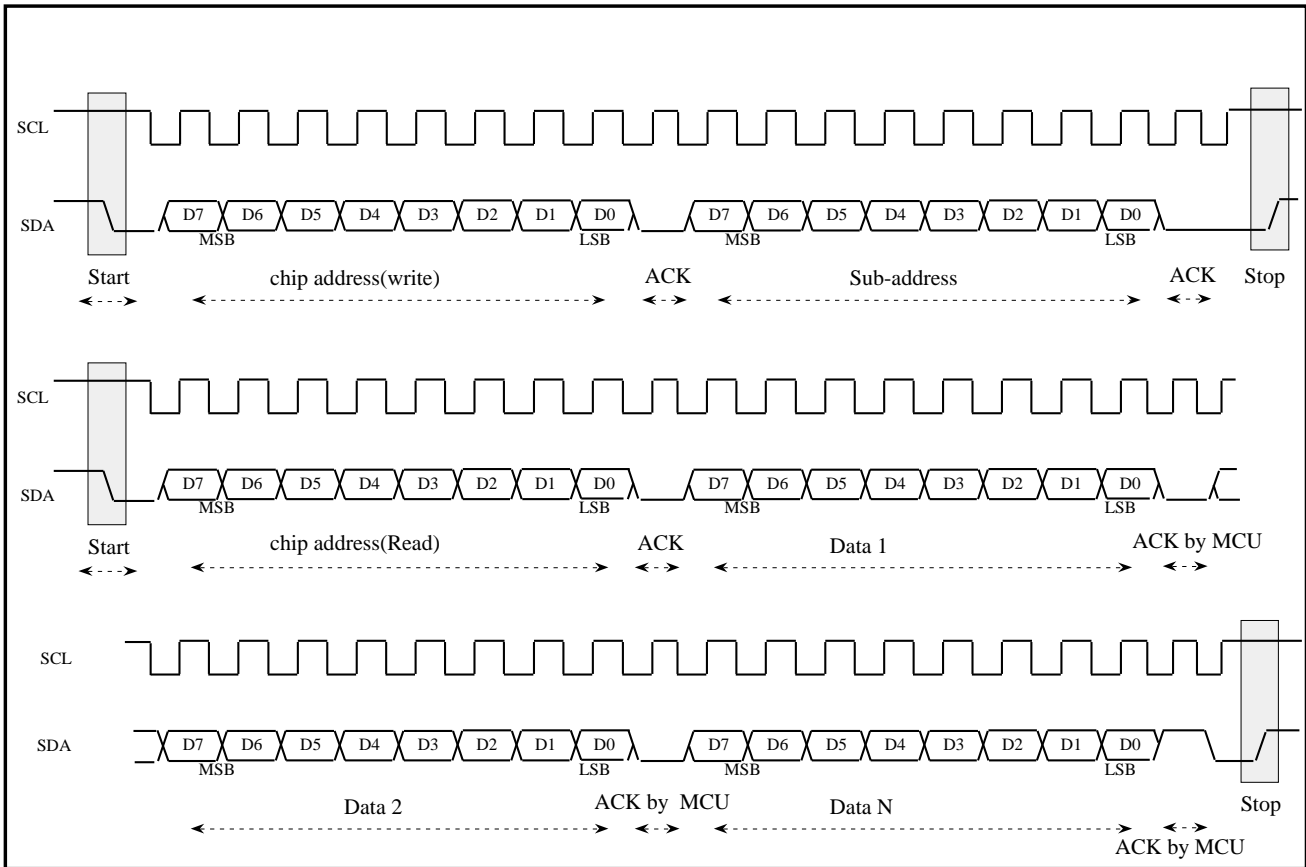



Fig 15-a : SPI-BUS Interface Write operation Timing

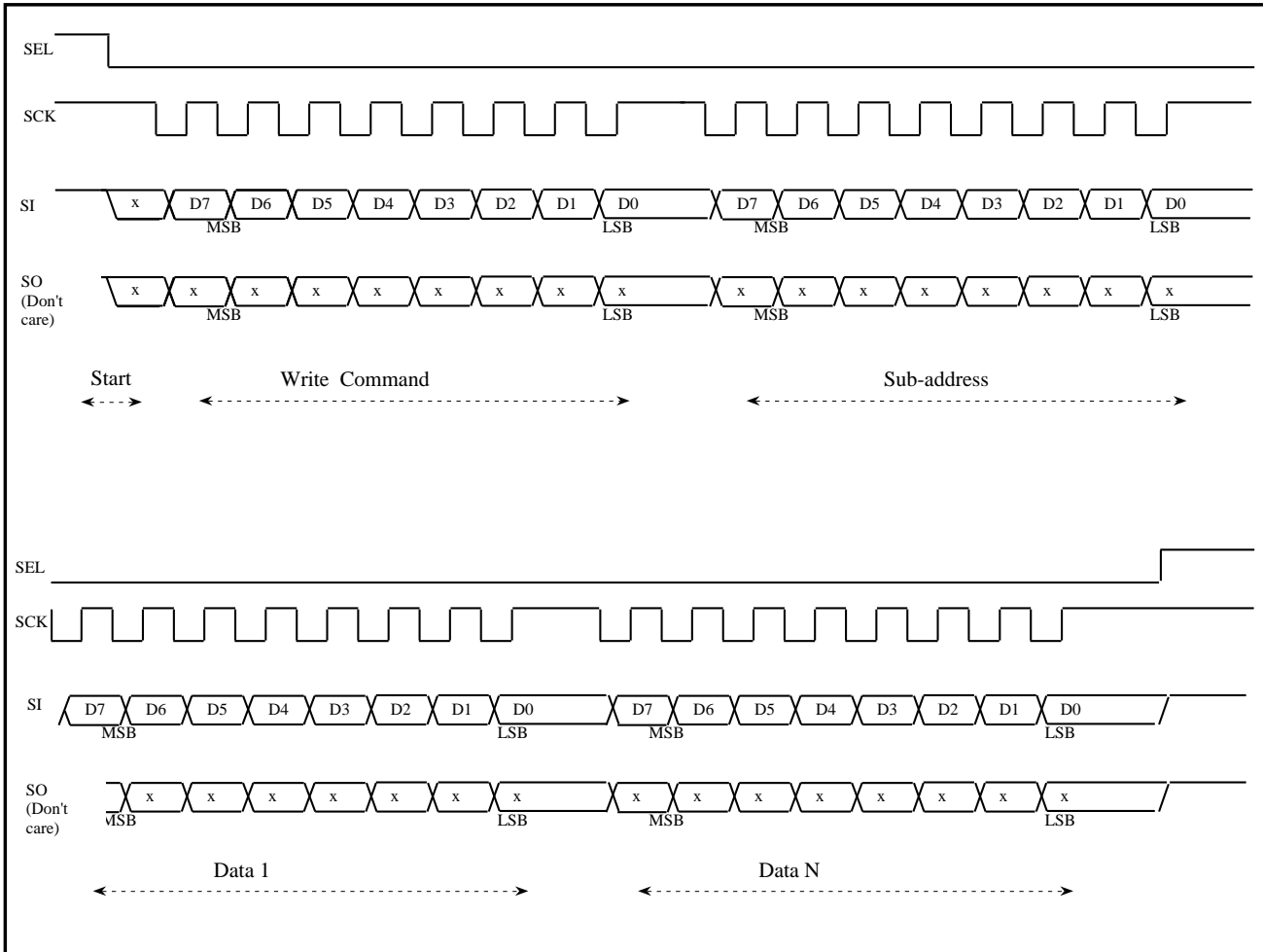
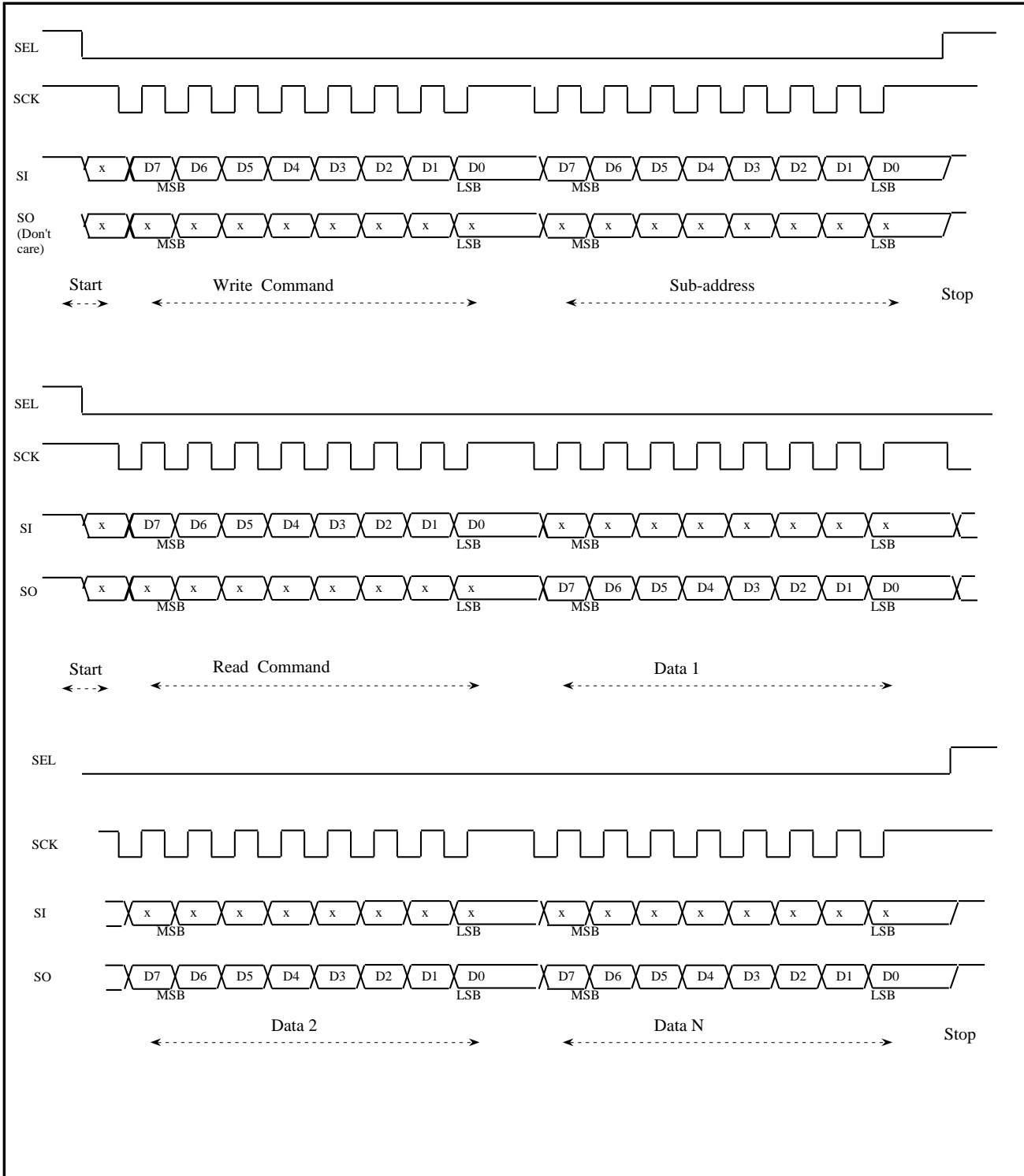



Fig 15-b : SPI-BUS Interface Read operation Timing



**[Specifications]**Maximum Ratings

DC Supply Voltage	Vdd	-0.5 ~ +7.0	V
Input Voltage, All Inputs	Vin	-1.5 ~ Vdd+1.5	V
Output Voltage, All Outputs	Vout	-0.5 ~ Vdd+1.5	V
DC Output Current, per Pin	Iout	25	mA
Power Dissipation	Pd	750	mW
Storage Temperature	Tstg	-65 ~ +150	°C

Electrical Characteristics

Characteristic	Symbol	Min	Typ	Max	Unit
Power Supply Voltage(Analog Blocks)	AVDD	3.1	3.3	3.5	V
DAVDD		4.75	5.0	5.25	
Power Supply Voltage(Digital Blocks)	DVDD	3.1	3.3	3.5	V
Supply Current(Analog Blocks)	Aicc	-	30	-	mA
Supply Current(Digital Blocks)	Dlcc	-	170	-	mA
Operating Temperature	Ta	0	-	70	°C

DAC Blocks Characteristics(Power Supply 3.3V, Ta=25°C)

Characteristics	Symbol	Min	Typ	Max	Unit	Other
Resolution	-	-	-	10	Bit	
Integral Non-Linearity	INL	-	-	±4.0	LSB	Vref = 1.1V
Differential Non-Linearity	DNL	-	-	±2.0	LSB	Vref = 1.1V
Analog Output Voltage	Vyo	0.85	1.00	1.15	Vp-p	Vref = 1.5V
Full Scale Output Voltage	Vyfs	0.85	1.00	1.15	V	
Zero Scale Output Voltage	Vyzs	-	0.0	0.1	V	
External Load Resistance	RL	75	120	-	Ω	

DAC Blocks Characteristics(Power Supply 5.0V, Ta=25°C)

Characteristics	Symbol	Min	Typ	Max	Unit	Other
Resolution	-	-	-	10	Bit	
Integral Non-Linearity	INL	-	-	±4.0	LSB	Vref = 1.5V
Differential Non-Linearity	DNL	-	-	±2.0	LSB	Vref = 1.5V
Analog Output Voltage	Vyo	-	1.5	2.0	Vp-p	Vref = 2V
Full Scale Output Voltage	Vyfs	-	1.5	2.0	V	Vref = 2V
Zero Scale Output Voltage	Vyzs	-	0.0	0.1	V	
External Load Resistance	RL	75	240	-	Ω	



[Specifications]

Clock Blocks Characteristics

Characteristic	Symbol	Min	Typ	Max	Unit
Clock Rate	fc	-	27.0	-	MHz
Clock Duty Cycle	Dty	40	50	60	%

Digital Blocks Electrical Characteristics (Power Supply 3.3V, Ta=25°C)

Characteristics	Symbol	Min	Typ	Max	Unit
Input Voltage HIGH	ViH	2.0	-	-	V
Input Voltage LOW	ViL	-	-	0.8	V
Output Voltage HIGH (2.0mA)	VoH	2.4	-	-	V
Output Voltage LOW	VoL	-	-	0.5	V
Input Leakage Current	Iin	-	±2.5	-	µA
Hi-Z Leakage Current	Ioz	-	±20	-	µA
Input Capacitance	Cin	-	-	20	pF
Load Capacitance	CL	-	-	20	pF
Data Setup Time	Tds	4	-	-	nS
Data Hold Time	Tdh	5	-	-	nS
Input Rise Time	Tr	-	-	5	nS
Input Fall Time	Tf	-	-	5	nS
Data delay	Td	-	-	27	nS

IIC/SPI-BUS Blocks Characteristics (Power Supply 3.3V, Ta=25°C)

Characteristics	Symbol	Min	Typ	Max	Unit
Input Voltage LOW	VILM	-	-	0.8	V
Input Voltage High	VIHM	2.3	-	-	V
Input Current	VIM	-	-	±10	µA
SDA Output Voltage (IOM=3mA)	VOM	-	-	0.4	V
Output Current (during acknowledge)	IOM	3	-	-	mA

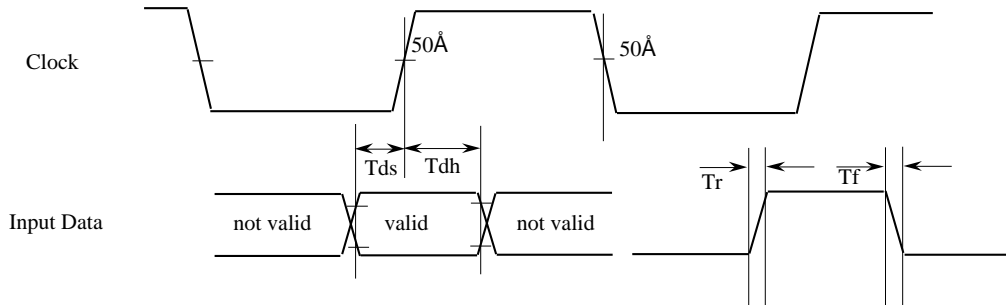



[I2C-BUS Slave Address 42(hex)/43(hex) or 1C(hex)/1D(hex)]

<I2C-Bus Format>

WRITE MODE

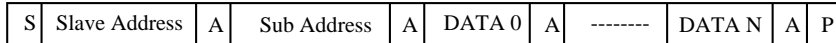

42(hex) or 1C(hex)

if more than 1byte DATA is transmitted,
then auto-increment of the Sub Address is performed

- S Start condition
- Slave Address 42(hex) or 1C(hex)
- A Acknowledge, generated by the slave
- Sub Address Sub address byte
- DATA 0 First data byte
- DATA N continued data byte(Sub Address is auto increment)
- P Stop condition

READ MODE

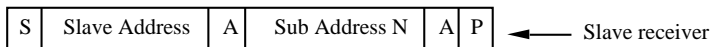

42(hex) or 1C(hex)

then



43(hex) or 1D(hex)

- S Start condition
- Slave Address Slave receiver is act transmitter is ad
- A Acknowledge, generated by the slave
- Sub Address N Sub Address byte
- DATA N DATA byte of Register N
- DATA N + 1 DATA byte of Register N + 1 (address auto-increment)
- AM Acknowledge, generated by the micro controller
- P Stop condition (When Last AM must be '1')



[SPI-BUS]

<SPI-Bus Format>

WRITE MODE

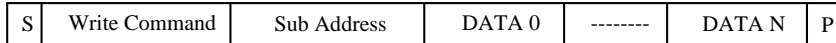

42(hex) or 1C(hex)

if more than 1byte DATA is transmitted,
then auto-increment of the Sub Address is performed

- S Chip select on (Hi to Lo)
- Write Command 42(hex) or 1C(hex)
- Sub Address Sub address byte
- DATA 0 First data byte
- DATA N continued data byte(Sub Address is auto increment)
- P Chip select off (Lo to Hi)

READ MODE

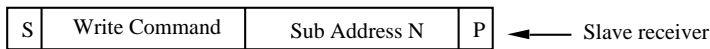

42(hex) or 1C(hex)

then



43(hex) or 1D(hex)

- S Chip select on (Hi to Lo)
- Sub Address N Sub Address byte set
- Read Command 43(hex) or 1D(hex)
- DATA N DATA byte of Register N
- DATA N + 1 DATA byte of Register N + 1 (address auto-increment)
- P Chip select off (Lo to Hi)



[Register Mapping and Description]

Sub-address 70 : Variable I/O Switch (write/read)

	MSB							LSB
Register 70	bs-off	self-SW	color bar select	VBLK SW	EXTsync SW	F/Vsync SW	M/S mode1	M/S mode0
	default : 0000_0001(bin)							

bs - off : color burst control switch On/Off
 0 : color burst ON (default)
 1 : color burst OFF

self - SW : internal self H/V counter reset switch On / Off
 0 : self counter reset OFF (default)
 1 : self counter reset ON
 Note : this mode is ONLY valid at when 70h[1: 0] is "10(bin)" or "11(bin)".

color bar select : color bar select

	Luma	Chroma
0 : color bar	100%	100%
1 : color bar	100%	75%

VBLK SW : Vertical Blanking Mask Enabale switch On-Off
 0 : reject VBI information data in vertical blanking period (default)
 1 : through VBI information data in vertical blanking period

EXTsync SW : Composite sync/Flame sync output switch
 0 : Frame sync output (default)
 1 : compsite sync output

F/Vsync SW : Flame sync /Vertical sync output switch
 0 : Vertical sync output (default)
 1 : Frame sync output

M/S sync mode1 : Master or Slave sync mode
 M/S sync mode0 : 00 : 656 slave or H/V master mode
 01 : 656 slave mode(no H/Vsync output) (default)
 10 : Fsync/Hsync slave mode
 11 : Vsync/Hsync slave mode



Sub-address 71 : Sync control (write/read)

	MSB							LSB
Register 71	non-inter	VBI SW	h-polarity	v-polarity	f-polarity	h- delay2	h-delay1	h-delay0

default : 0000_0100(bin)

- non-inter : non-interlaced mode select
0 : interlace mode (default)
1 : non-interlace mode
- VBI SW : vertical blanking information signal input control switch on EXT pin
0 : VBI input Off (default)
1 : VBI input On
- h-polarity : polarity of Hsync
0 : negative (default)
1 : positive
- v-polarity : polarity of Vsync
0 : negative (default)
1 : positive
- f-polarity : polarity of Fsync
0 : field1 (odd) = low level (default)
1 : field1 (odd) = high level
- h-delay2 : delay on Hsync with referance to DVIN data in Master mode
- h-delay1 : 000: + 4 clock delay
- h-delay0 : 001: + 3 clock delay
010: + 2 clock delay
011: + 1 clock delay
100: + 0 clock delay
101: - 1 clock delay
110: - 2 clock delay
111: - 3 clock delay

Note : this h-delay can be also related with 7A[7:0] register and can delay totally +2023 clock delay in H/V or H/Fsynnc slave mode.



Sub-address 72 : PAL/NTSC setup (write / read)

	MSB							LSB
Register 72	phase-set	TEST	EXT I/O SW	color bar	setup75	625/525	PAL/NTSC2	PAL/NTSC1

default : 0000_1000(bin) NTSC (If "PAL/NTSC" pin is LOW level)
 0000_0101(bin) PAL

phase-set : color sub-carrier phase synchronization
 0 : free running (default)
 1 : 1 phase reset/8 field and 1 phase reset/4 flam

TSET : for test, should be "0"

EXT I/O SW : Input/Output switch on EXT pin
 0 : VBI input(default)
 1 : Csync or Flame sync output

color bar : internal color bar generator control
 0 : nomal operation (default)
 1 : color bar generator On
 (need to set color bar mode on sub-address 70[5].)

setup75 : Setup level for Luminance
 0 : setup level for luminunce = 0IRE
 1 : setup level for luminunce = 7.5IRE

625/525 : control line mode
 0 : 525 lines / 60 Hz mode
 1 : 625 lines / 50 Hz mode

PAL/NTSC2 : subcarrier control
 PAL/NTSC1 00 : NTSC(M)
 01 : PAL (BDGHI)
 10 : PAL (M)
 11 : PAL (N)



Sub-address 73: Vertical Blanking Information Luma (Y) Level (write only)

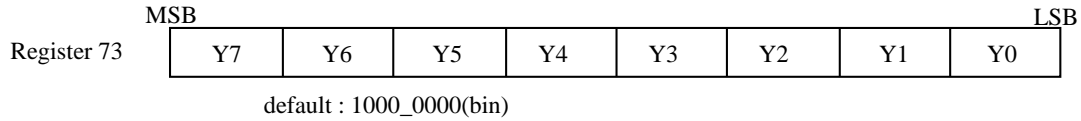

Sub-address 74: Vertical Blanking Information Chroma (U) Level (write only)

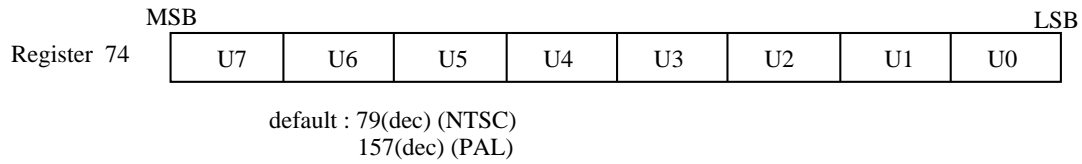

Sub-address 75: Vertical Blanking Information Chroma (V) Level (write only)

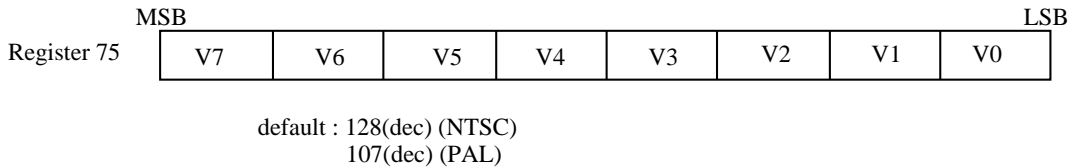



Sub-address 76 : signal control 1(write only)

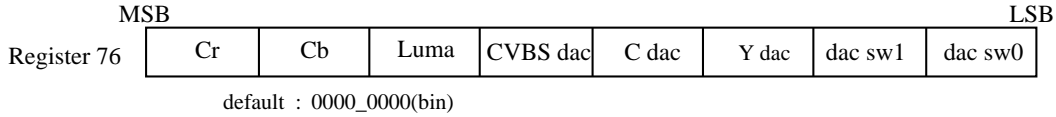

- Cr : Cr/Cb signal control
- Cb : 0 : Cr, Cb On (default)
1 : chrominance Off
- Luma : luminance control
0 : luminance On (default)
1 : luminance Off
- CVBSdac : D/A converter output On-Off control
- Cdac : 0 : CVBS/CbDAC, C/CrDAC, YDAC output On (default)
- Ydac : 1 : CVBS/CbDAC, C/CrDAC, YDAC output Off
- dac sw1 : 1~9-pin's D/A converter output signal control
- dac sw0 : 10 : Y/Cr/Cb output On
00 : Y/C/CVBS output On

Sub-address 77 : signal control 2 (write only)

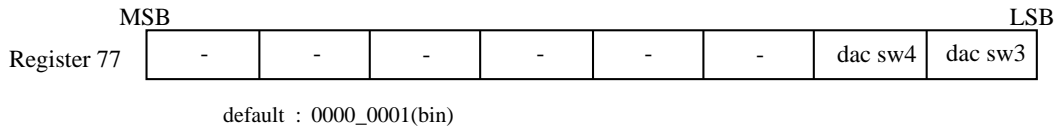

- dac sw4 : D/A converter output signal control
- dac sw3 : 10 : Y/Cr/Cb output On
00 : Y/C/CVBS output On



Sub-address 78~79 : Sub-carrier phase control (write only)

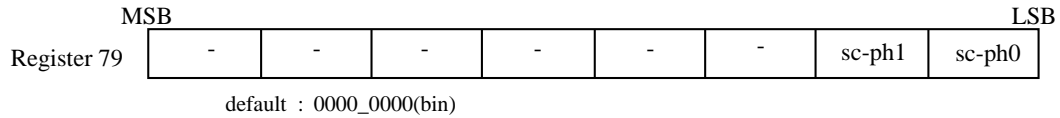
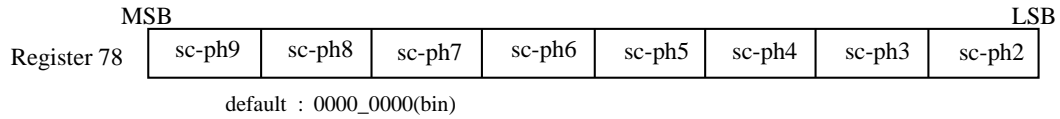

sc-ph9 : sub-carrier phase control
 sc-ph8 0000_0000 : sub-carrier phase 0 degree (default)
 sc-ph7 to
 sc-ph6 1111_1111 : sub-carrier phase 359 degree
 sc-ph5
 sc-ph4
 sc-ph3
 sc-ph2
 sc-ph1
 sc-ph0

Sub-address 7A : Hsync delay control (write only)

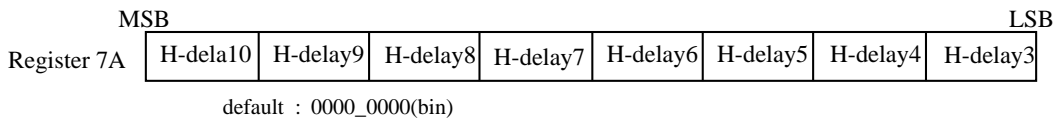

h-delay10 : delay on Hsync with reference to DVIN data
 h-delay9 0000_0000_000 : Hsync delay 0 delay
 h-delay8 to
 h-delay7 1111_1111_000 : Hsync delay +255 delay
 h-delay6
 h-delay5
 h-delay4
 h-delay3

Note : this h-delay can be also related with 71[3:0] register and can delay totally +2023 delay(1111_1111_111) in H/V or H/ Fsync slave mode.



Sub-address 7B : Digital Video Input Select Control (write only)

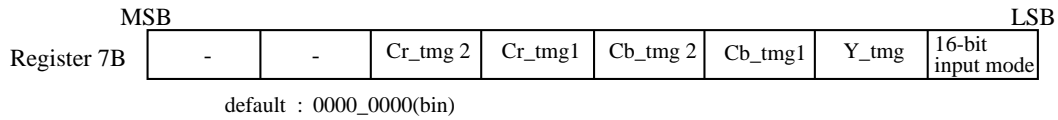

Cr/Cb_tmg2 : Cr/Cb clock timing delay in 16-bit Digital Input Mode
Cr/Cb_tmg1 00 : Cr clock delay 0 clock (default)
 01 : Cr clock delay +1 clock
 10 : Cr clock delay +2 clock
 11 : Cr clock delay +3 clock

Y_tmg : Y clock timing delay in 16-bit Digital Input Mode
 0 : Y clock delay 0 clock (default)
 1 : Y clock delay +1 clock

16-bit input mode : 16-bit Multiplexed CbYCrY Digital Video Inout mode
 0 : 8-bit CbYCrY Digital Video Input mode (default)
 1 : 16-bit CbYCrY Digital Video Input mode



Sub-address 80~82: CGMS characters for Field1(Line20)/Field2(Line283) (write only)

NTSC only

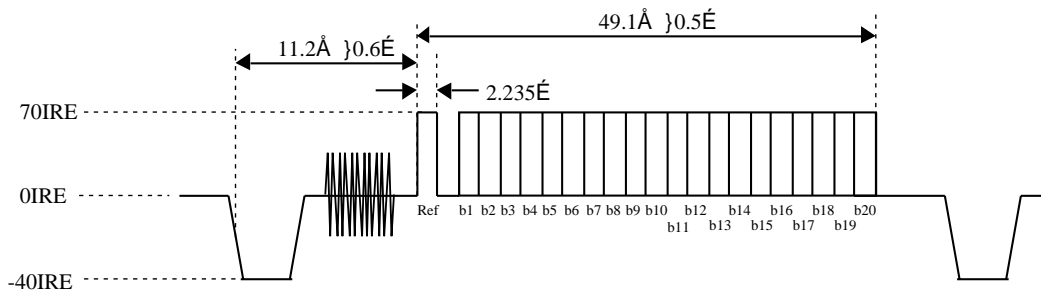
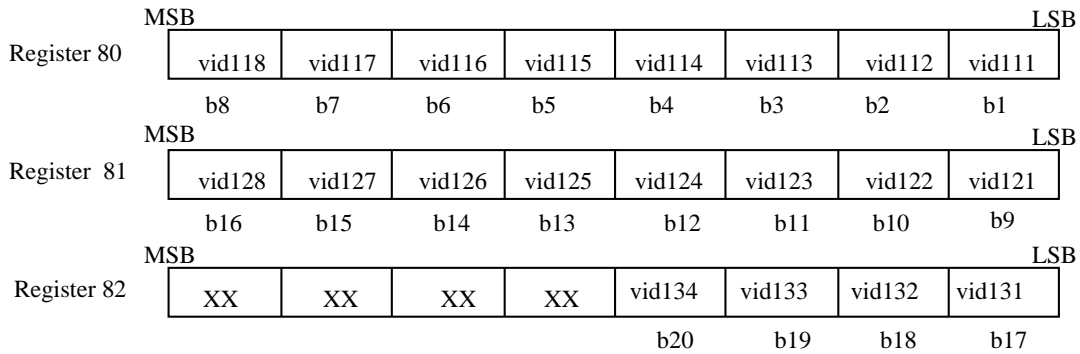

Fig 16 : CGMS wave form



Sub-address 83~84 :closed caption characters/extended data for Field1(Line21) (write only)

default 1000_0000

First byte to Encode

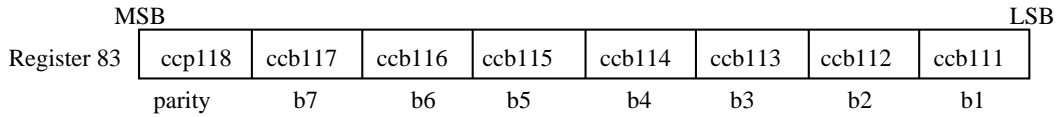

Second byte to Encode

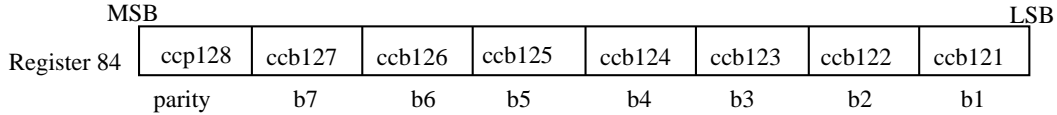

Sub-address 85~86 :closed cation character/extended data for Field2(Line284)

First byte to Encode

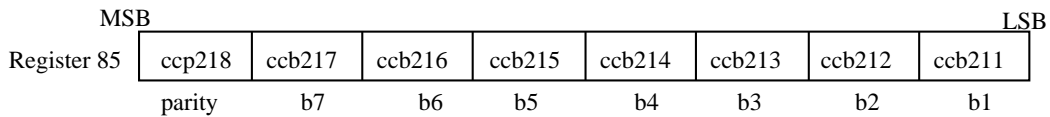

Second byte to Encode

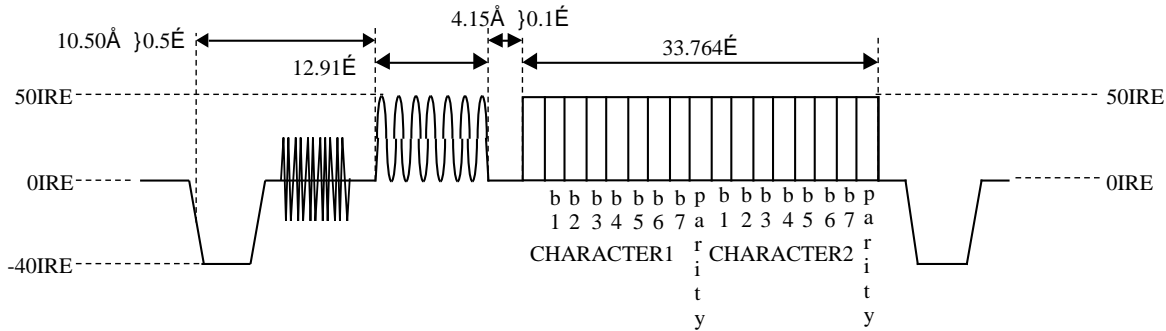
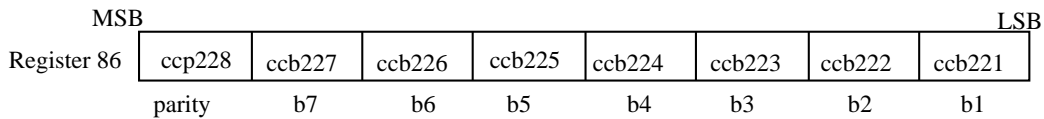

Fig 17 : Closed caption wave form

sub-address 83 & 84 and 85 & 86 (previous frame data) are double-buffered by Flame sync falling edge

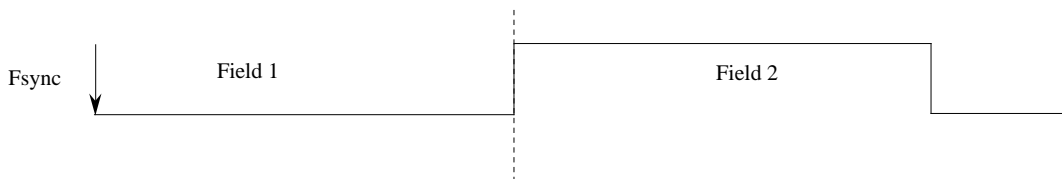
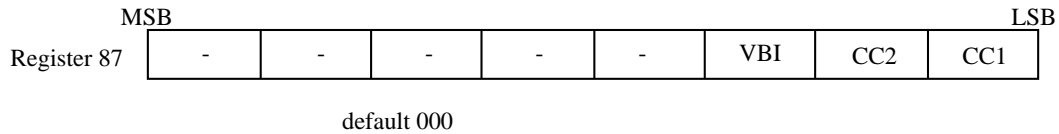

Fig 18 : Closed caption data update timing



Sub-address 87 :Closed caption/CGMS



- VBI : CGMS information data insertion On-Off
0 : CGMS information data insertion Off
1 : CGMS information data insertion On

- CC2 : closed caption/extended data for field2 encoding On-Off
0 : closed caption/extended data for field2 encoding Off
1 : closed caption/extended data for field2 encoding On

- CC1 : closed caption/extended data for field1 encoding
0 : closed caption/extended data for field1 encoding Off
1 : closed caption/extended data for field1 encoding On



device-address 42, 43(hex) or 1C, 1D(hex)

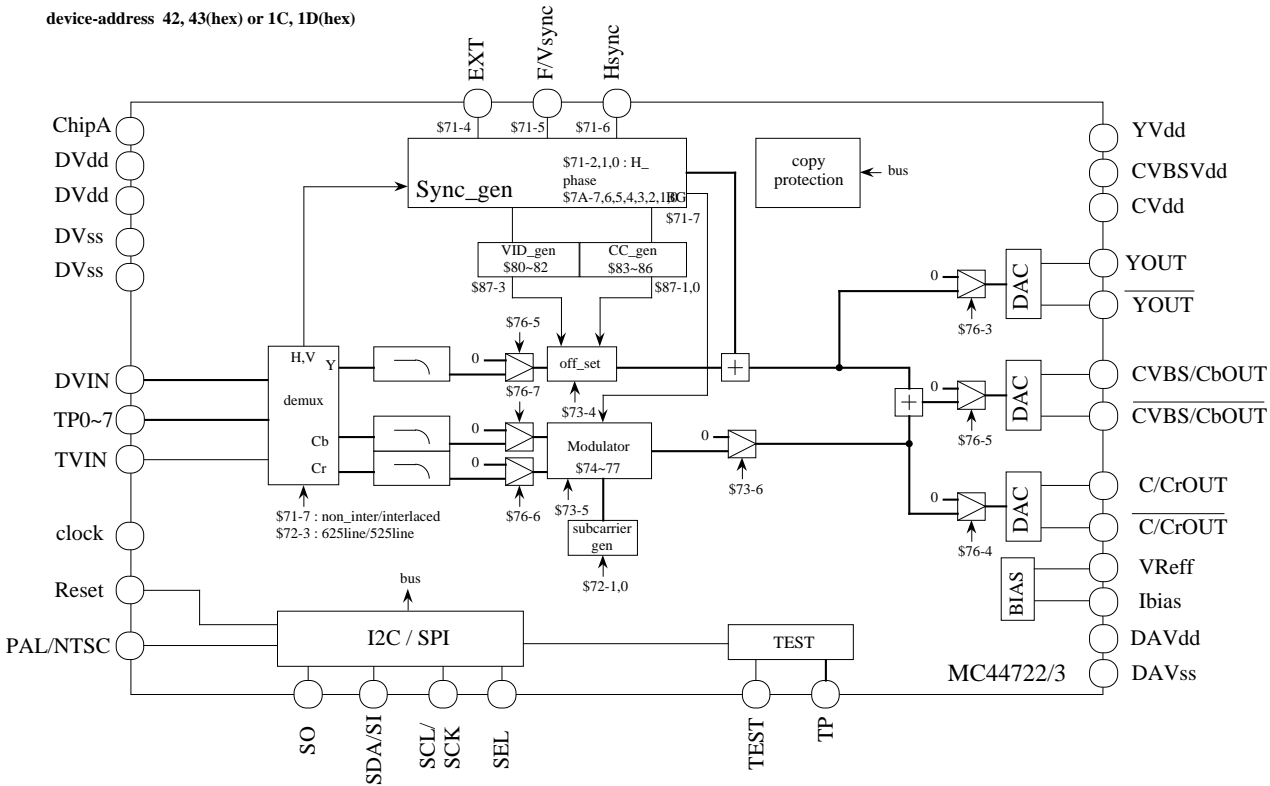

%% I2C-BUS Slave Receiver Sub-address map %%

70h[7]	burst control (default 0:on)	77h[7:0]	n.a
[6]	self counter reset switch (default 0:off)	78h[7:0]	sub-carrier phase control(default 00h)
[5]	color bar select (default 0:Luma 100% Chroma 100%)	79h[1:0]	sub-carrier phase control(default 00)
[4]	vertical blanking switch(default 0:off)	79h[7:2]	n.a.
[3]	EXT pin output mode select (Csync:1, Flame sync:0)	7A[7:0]	hsync-delay control (In slave mode, is valid with 71h[2:] register)
[2]	F/Vsync select(default 0:Vsync)	7B[7:6]	n.a
[1:0]	Master/Slave mode select(default 01:656_slave)	7B[5:4]	Cr clock timing delay in 16-bit digital input mode
71h[7]	interlaced / non-interlaced (default 0:interlaced)	7B[3:2]	Cb clock timing delay in 16-bit digital input mode
[6]	VBI input control on EXT pin (default 0:off)	7B[1]	Y clock timing delay in 16-bit digital input mode
[5]	horizontal sync polarity (default 0)	7B[0]	16-bit multiplexed CbYCrY digital input mode (default 0: 8-bit multiplexed CbYCrY mode)
[4]	vertical sync polarity (default 0)	80~82h:	Video ID characters for field1(line20)/field2(line283)
[3]	flame sync polarity (default 0)	83h[7:0]	CC character1(line21) (default 'h80)
[2:0]	hsync delay control (default 100:0 clock delay) (In slave mode can use with 7A[7:0])	84h[7:0]	CC character2(line21) (default 'h80)
72h[7]	sub-carrier phase syncronaiation(default 0)	85h[7:0]	CC character1(line284) (default 'h80)
[6]	Test mode (default 0:off)	86h[7:0]	CC character2(line284) (default 'h80)
[5]	EXT I/O switch(default 1:cysnc output)	87h[7:3]	n.a.
[4]	color bar generate(default 0:off)	[2]	CGMS on/off (default 0: off)
[3]	setup level control(default 1:7.5IRE)	[1]	CC closed caption/extended data for field2 encoding (default 0: off)
[2]	625lines50Hz/525Lines60Hz (default set PAL/NTSC pin)	[0]	CC closed caption/extended data for field1 encoding (default 0: off)
[1:0]	PAL/NTSC (default set PAL/NTSC pin)		
	00:NTSC/M		
	01:PAL/BGHL		
	(10:PAL/M) (11:PAL/N)		
73h[7:0]	Y_register(default 80h)		
74h[7:0]	U_register(default 79d:ntsc/157d:PAL)		
75h[7:0]	V_register(default 128d:ntsc/107d:PAL)		
76h[7]	Cr on/off (default 0:on)		
[6]	Cb on/off (default 0:on)		
[5]	Luma on/off(default 0:on) (default 0: on)		
[4]	CVBS/Cb DAC on/off(default 0: on)		
[3]	C/Cr DAC on/off(default 0: on)		
[2]	C/Cr DAC on/off(default 0: on)		
[1]	CBVS/Y/C Y/Cr/Cb output control switch (default 0 : CBVS/Y/C output)		
[0]	reserved		

<<<<<<< M-BUS Format >>>>>>

```

** WRITE MODE **
S | Slave_address(W) | A | Sub_address | A | Data0 | A | ... | DataN | A | P

S
Slave_address      42(hex) or 1C(hex)
A                  Acknowledge generated by me
Sub_address        Sub_address register
Data0              First data
DataN              Continued data(address is auto incremented)
P                  Stop condition

```

<<<<<<< SPI-Bus Format >>>>>>

```

** WRITE MODE **
S | Write Command | Sub_address | Data0 | ... | DataN | P

S
Write Command      Chip select on (High to Low)
Sub_address        42(hex) or 1C(hex)
Data0              Sub_address byte
DataN              First data
DataN              Continued data byte(address is auto incremented)
P                  Chip select off (Low to High)

```



[Application Diagram]

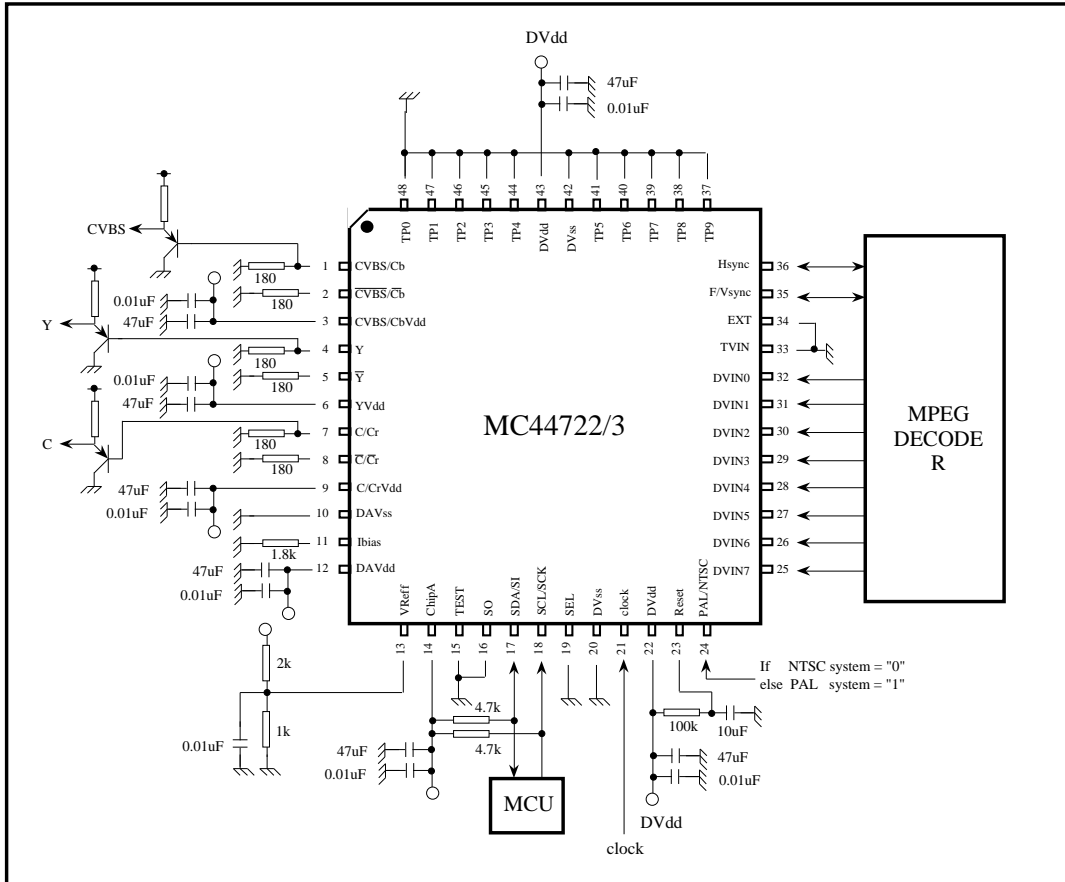



Package

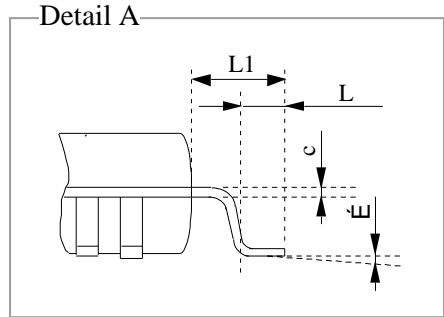
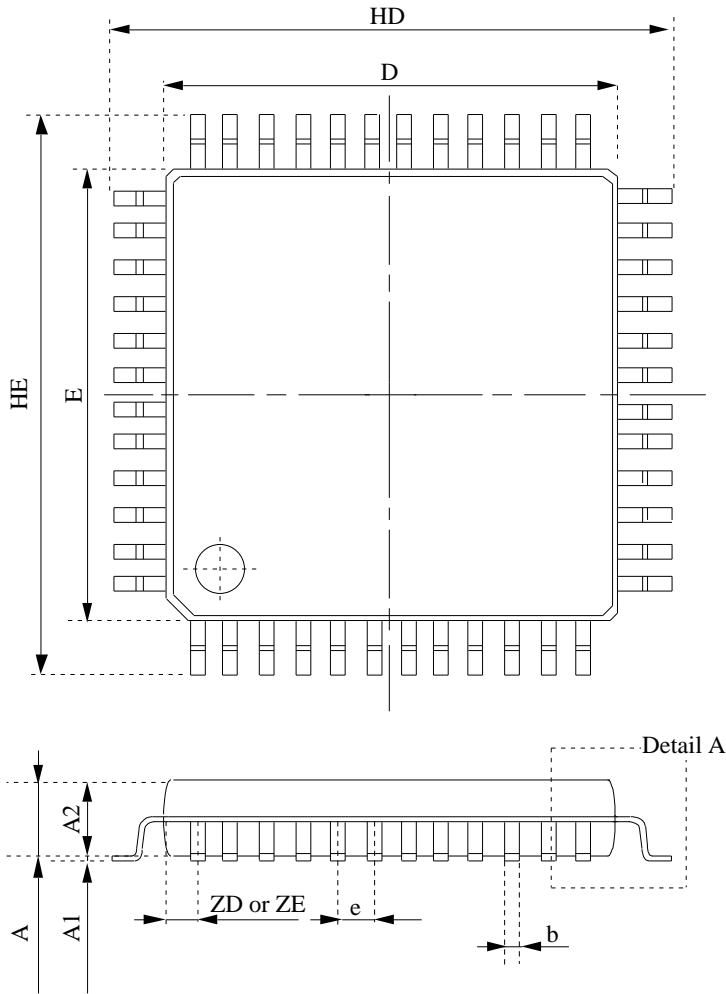

	min	max
A	-	1.70
A1	0.05	0.15
A2	1.40TYP	
b	0.3	0.45
c	0.10	0.20
D	11.90	12.10
E	11.90	12.10
e	0.80	
HD	13.80	14.20
HE	13.80	14.20
L	0.30	0.70
L1	0.80	1.20
É	0	10
y	-	0.10
ZD	1.60	
ZE	1.60	

unit : mm