

The RF MOSFET Line
RF Power
Field Effect Transistors
N-Channel Enhancement Mode MOSFETs

Designed for broadband commercial and military applications up to 200 MHz frequency range. The high-power, high-gain and broadband performance of these devices make possible solid state transmitters for FM broadcast or TV channel frequency bands.

- Guaranteed Performance at 150 MHz, 28 V:
Output Power = 80 W
Gain = 11 dB (13 dB Typ)
Efficiency = 55% Min. (60% Typ)
- Low Thermal Resistance
- Ruggedness Tested at Rated Output Power
- Nitride Passivated Die for Enhanced Reliability
- Low Noise Figure — 1.5 dB Typ at 2.0 A, 150 MHz
- Excellent Thermal Stability; Suited for Class A Operation

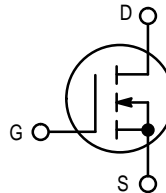

MRF173
MRF173CQ

80 W, 28 V, 175 MHz
N-CHANNEL
BROADBAND
RF POWER MOSFETs

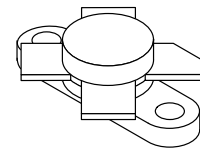

CASE 211-11, STYLE 2
(MRF173)

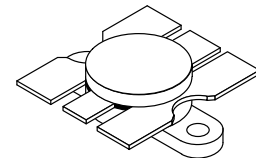

CASE 316-01, STYLE 2
(MRF173CQ)

MAXIMUM RATINGS

Rating	Symbol	Value	Unit
Drain-Source Voltage	V_{DSS}	65	Vdc
Drain-Gate Voltage	V_{DGO}	65	Vdc
Gate-Source Voltage	V_{GS}	± 40	Vdc
Drain Current — Continuous	I_D	9.0	Adc
Total Device Dissipation @ $T_C = 25^\circ\text{C}$ Derate above 25°C	P_D	220 1.26	Watts W/ $^\circ\text{C}$
Storage Temperature Range	T_{stg}	-65 to +150	$^\circ\text{C}$
Operating Temperature Range	T_J	200	$^\circ\text{C}$

THERMAL CHARACTERISTICS

Characteristic	Symbol	Max	Unit
Thermal Resistance, Junction to Case	$R_{\theta JC}$	0.8	$^\circ\text{C}/\text{W}$

ELECTRICAL CHARACTERISTICS ($T_C = 25^\circ\text{C}$ unless otherwise noted)

Characteristic	Symbol	Min	Typ	Max	Unit
----------------	--------	-----	-----	-----	------

OFF CHARACTERISTICS

Drain-Source Breakdown Voltage ($V_{DS} = 0\text{ V}$, $V_{GS} = 0\text{ V}$) $I_D = 50\text{ mA}$	$V_{(BR)DSS}$	65	—	—	V
Zero Gate Voltage Drain Current ($V_{DS} = 28\text{ V}$, $V_{GS} = 0\text{ V}$)	I_{DSS}	—	—	2.0	mA
Gate-Source Leakage Current ($V_{GS} = 40\text{ V}$, $V_{DS} = 0\text{ V}$)	I_{GSS}	—	—	1.0	μA

ON CHARACTERISTICS

Gate Threshold Voltage ($V_{DS} = 10\text{ V}$, $I_D = 50\text{ mA}$)	$V_{GS(th)}$	1.0	3.0	6.0	V
Drain-Source On-Voltage ($V_{DS(on)}$, $V_{GS} = 10\text{ V}$, $I_D = 3.0\text{ A}$)	$V_{DS(on)}$	—	—	1.4	V
Forward Transconductance ($V_{DS} = 10\text{ V}$, $I_D = 2.0\text{ A}$)	g_{fs}	1.8	2.2	—	mhos

(continued)

NOTE — **CAUTION** — MOS devices are susceptible to damage from electrostatic charge. Reasonable precautions in handling and packaging MOS devices should be observed.

ELECTRICAL CHARACTERISTICS — continued ($T_C = 25^\circ\text{C}$ unless otherwise noted)

Characteristic	Symbol	Min	Typ	Max	Unit
DYNAMIC CHARACTERISTICS					
Input Capacitance ($V_{DS} = 28\text{ V}$, $V_{GS} = 0\text{ V}$, $f = 1.0\text{ MHz}$)	C_{iSS}	—	110	—	pF
Output Capacitance ($V_{DS} = 28\text{ V}$, $V_{GS} = 0\text{ V}$, $f = 1.0\text{ MHz}$)	C_{oSS}	—	105	—	pF
Reverse Transfer Capacitance ($V_{DS} = 28\text{ V}$, $V_{GS} = 0\text{ V}$, $f = 1.0\text{ MHz}$)	C_{rSS}	—	10	—	pF
FUNCTIONAL CHARACTERISTICS					
Noise Figure ($V_{DD} = 28\text{ V}$, $f = 150\text{ MHz}$, $I_{DQ} = 50\text{ mA}$)	NF	—	1.5	—	dB
Common Source Power Gain ($V_{DD} = 28\text{ V}$, $P_{out} = 80\text{ W}$, $f = 150\text{ MHz}$, $I_{DQ} = 50\text{ mA}$)	G_{ps}	11	13	—	dB
Drain Efficiency ($V_{DD} = 28\text{ V}$, $P_{out} = 80\text{ W}$, $f = 150\text{ MHz}$, $I_{DQ} = 50\text{ mA}$)	η	55	60	—	%
Electrical Ruggedness ($V_{DD} = 28\text{ V}$, $P_{out} = 80\text{ W}$, $f = 150\text{ MHz}$, $I_{DQ} = 50\text{ mA}$) Load VSWR 30:1 at all phase angles	ψ	No Degradation in Output Power			
Series Equivalent Input Impedance ($V_{DD} = 28\text{ V}$, $P_{out} = 80\text{ W}$, $f = 150\text{ MHz}$, $I_{DQ} = 50\text{ mA}$)	MRF173 Z_{in}	—	$2.99 - j4.5$	—	Ohms
Series Equivalent Output Impedance ($V_{DD} = 28\text{ V}$, $P_{out} = 80\text{ W}$, $f = 150\text{ MHz}$, $I_{DQ} = 50\text{ mA}$)	MRF173 Z_{out}	—	$2.68 - j1.3$	—	Ohms
Series Equivalent Input Impedance ($V_{DD} = 28\text{ V}$, $P_{out} = 80\text{ W}$, $f = 150\text{ MHz}$, $I_{DQ} = 50\text{ mA}$)	MRF173CQ Z_{in}	—	$1.35 - j5.15$	—	Ohms
Series Equivalent Output Impedance ($V_{DD} = 28\text{ V}$, $P_{out} = 80\text{ W}$, $f = 150\text{ MHz}$, $I_{DQ} = 50\text{ mA}$)	MRF173CQ Z_{out}	—	$2.72 - j149$	—	Ohms

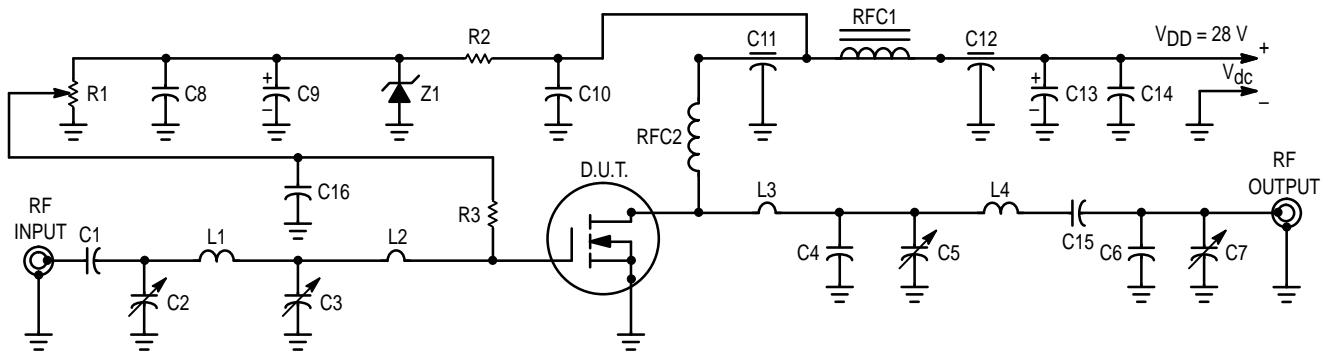

- C1, C15 — 470 pF Unelco
- C2, C3, C5 — 9–180 pF, Arco 463
- C4, C6 — 15 pF, Unelco
- C7 — 5–80 pF, Arco 462
- C8, C10, C14, C16 — 0.1 μF
- C9, C13 — 50 μF , 50 Vdc
- C11, C12 — 680 pF, Feed Through
- L1 — #16 AWG, 1–1/4 Turns, 0.3" ID
- L2 — #16 AWG Hairpin 1" long

- L3 — #14 AWG Hairpin 0.8" long
- L4 — #14 AWG Hairpin 1.1" long
- RFC1 — Ferroxcube VK200–19/4B
- RFC2 — 18 Turns #18 AWG Enameled, 0.3" ID
- R1 — 10 k Ω , 10 Turns Bourns
- R2 — 1.8 k Ω , 1/4 W
- R3 — 10 k Ω , 1/2 W
- Z1 — 1N5925A Motorola Zener

Figure 1. 150 MHz Test Circuit

TYPICAL CHARACTERISTICS

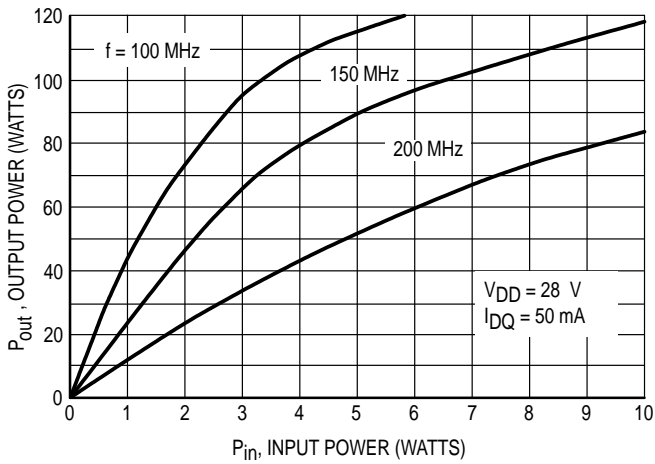

Figure 2. Output Power versus Input Power

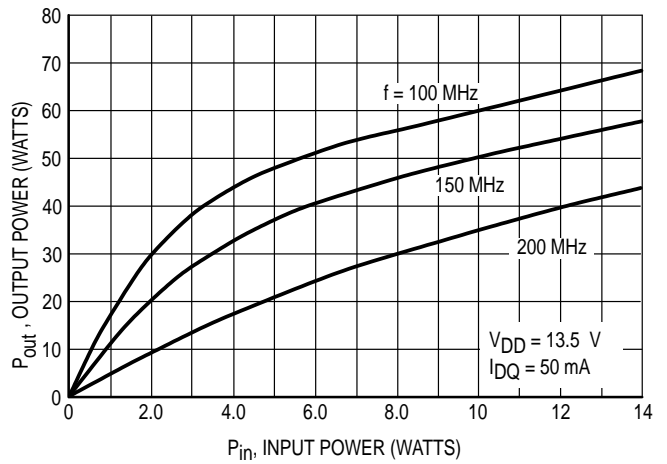

Figure 3. Output Power versus Input Power

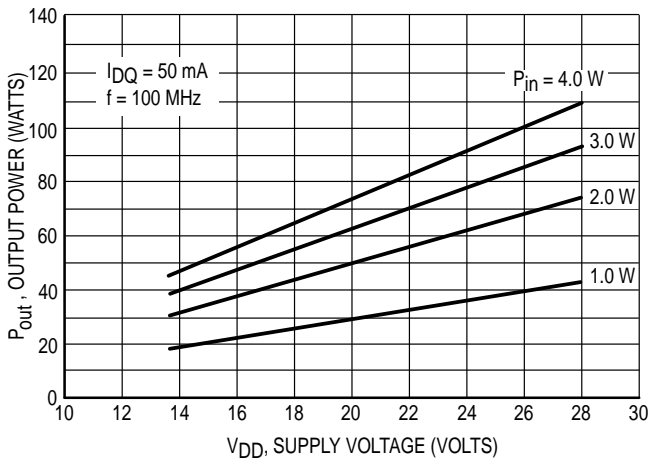

Figure 4. Output Power versus Supply Voltage

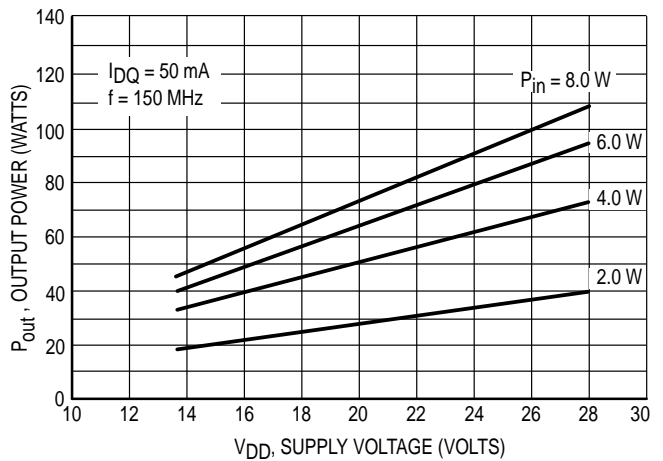

Figure 5. Output Power versus Supply Voltage

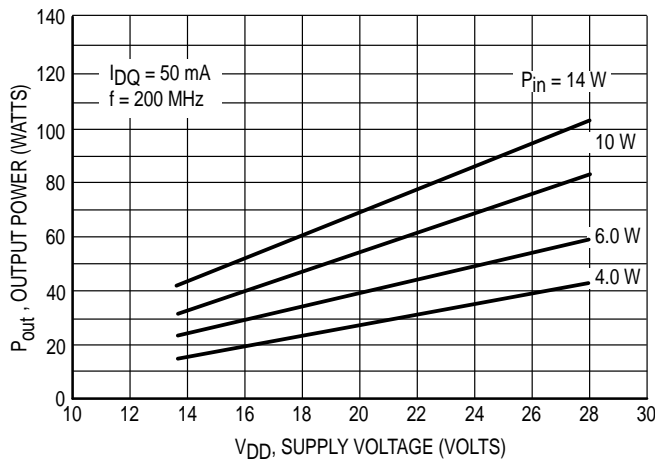

Figure 6. Output Power versus Supply Voltage

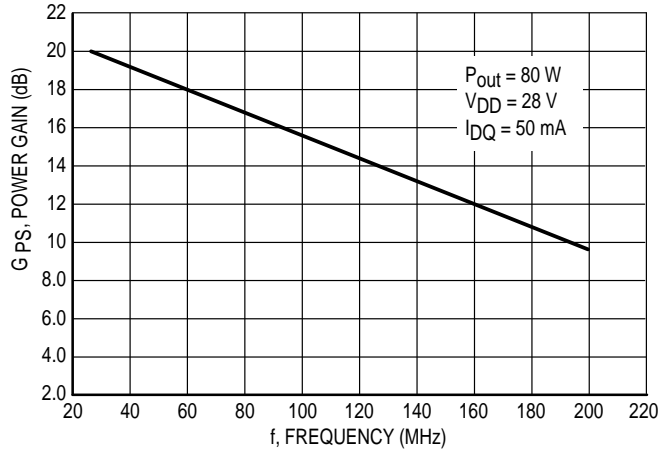

Figure 7. Power Gain versus Frequency

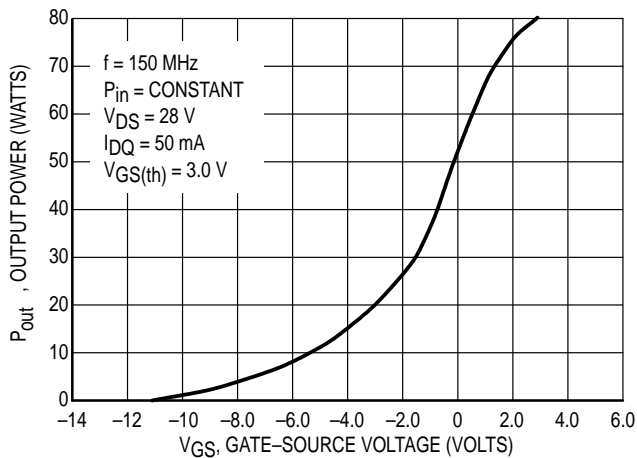

Figure 8. Output Power versus Gate Voltage

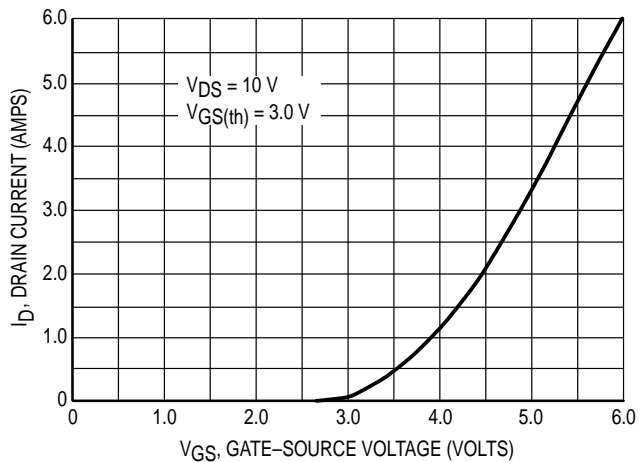

Figure 9. Drain Current versus Gate Voltage

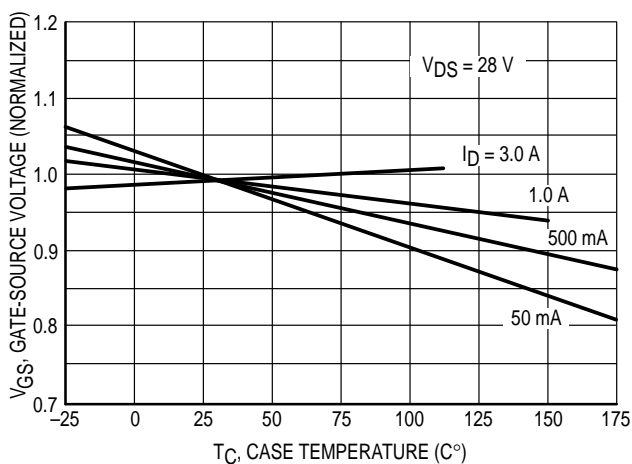

Figure 10. Gate-Source Voltage versus Case Temperature

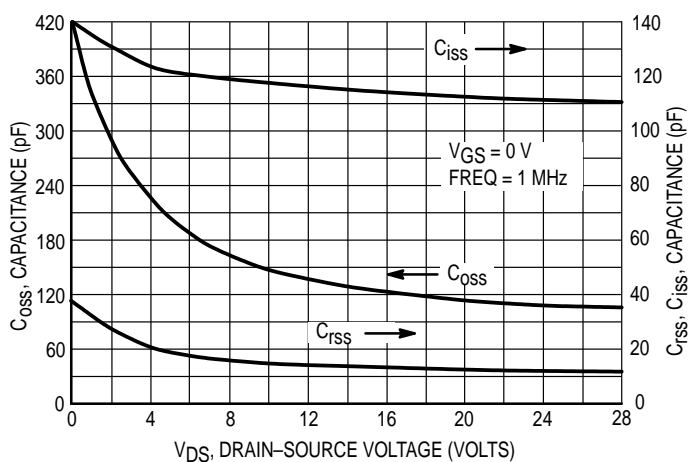

Figure 11. Capacitance versus Drain Voltage

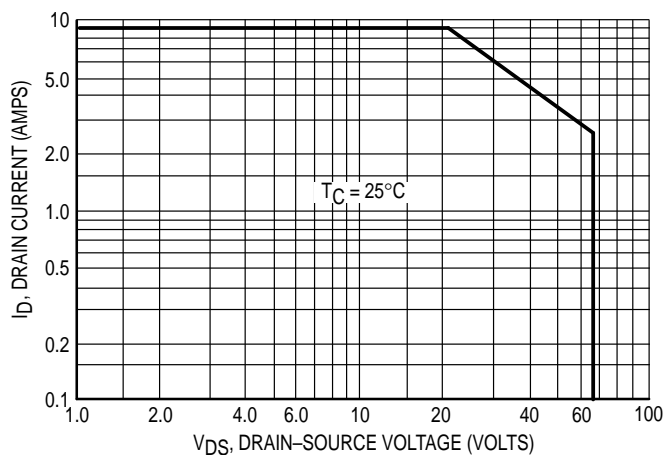

Figure 12. DC Safe Operating Area

DESIGN CONSIDERATIONS

The MRF173/CQ is a RF MOSFET power N-channel enhancement mode field-effect transistor (FET) designed for VHF power amplifier applications. Motorola's RF MOSFETs feature a vertical structure with a planar design, thus avoiding the processing difficulties associated with V-groove power FETs.

Motorola Application Note AN211A, FETs in Theory and Practice, is suggested reading for those not familiar with the construction and characteristics of FETs.

The major advantages of RF power FETs include high gain, low noise, simple bias systems, relative immunity from thermal runaway, and the ability to withstand severely mismatched loads without suffering damage. Power output can be varied over a wide range with a low power dc control signal, thus facilitating manual gain control, ALC and modulation.

DC BIAS

The MRF173/CQ is an enhancement mode FET and, therefore, does not conduct when drain voltage is applied. Drain current flows when a positive voltage is applied to the gate. See Figure 9 for a typical plot of drain current versus gate voltage. RF power FETs require forward bias for optimum performance. The value of quiescent drain current (I_{DQ}) is not critical for many

applications. The MRF173/CQ was characterized at $I_{DQ} = 50$ mA, which is the suggested minimum value of I_{DQ} . For special applications such as linear amplification, I_{DQ} may have to be selected to optimize the critical parameters.

The gate is a dc open circuit and draws no current. Therefore, the gate bias circuit may generally be just a simple resistive divider network. Some special applications may require a more elaborate bias system.

GAIN CONTROL

Power output of the MRF173/CQ may be controlled from its rated value down to zero (negative gain) by varying the dc gate voltage. This feature facilitates the design of manual gain control, AGC/ALC and modulation systems. (see Figure 8.)

AMPLIFIER DESIGN

Impedance matching networks similar to those used with bipolar VHF transistors are suitable for MRF173/CQ. See Motorola Application Note AN721, Impedance Matching Networks Applied to RF Power Transistors. The higher input impedance of RF MOSFETs helps ease the task of broadband network design. Both small-signal scattering parameters and large-signal impedances are provided. While the s-parameters will not produce an exact design solution for high power operation, they do yield a good first approximation. This is an additional advantage of RF MOS power FETs.

PACKAGE DIMENSIONS

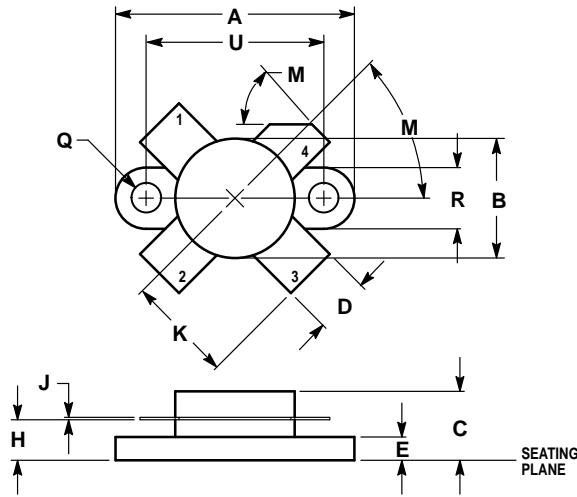

- NOTES:
 1. DIMENSIONING AND TOLERANCING PER ANSI Y14.5M, 1982.
 2. CONTROLLING DIMENSION: INCH.

DIM	INCHES		MILLIMETERS	
	MIN	MAX	MIN	MAX
A	0.960	0.990	24.39	25.14
B	0.465	0.510	11.82	12.95
C	0.229	0.275	5.82	6.98
D	0.216	0.235	5.49	5.96
E	0.084	0.110	2.14	2.79
H	0.144	0.178	3.66	4.52
J	0.003	0.007	0.08	0.17
K	0.435	—	11.05	—
M	45°NOM		45°NOM	
Q	0.115	0.130	2.93	3.30
R	0.246	0.255	6.25	6.47
U	0.720	0.730	18.29	18.54

- STYLE 2:
 PIN 1. SOURCE
 2. GATE
 3. SOURCE
 4. DRAIN

**CASE 211-11
 ISSUE N**

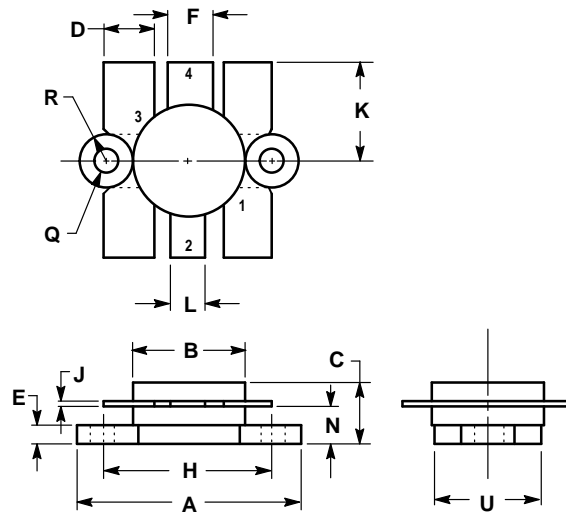

- NOTES:
 1. FLANGE IS ISOLATED IN ALL STYLES.

DIM	INCHES		MILLIMETERS	
	MIN	MAX	MIN	MAX
A	24.38	25.14	0.960	0.990
B	12.45	12.95	0.490	0.510
C	5.97	7.62	0.235	0.300
D	5.33	5.58	0.210	0.220
E	2.16	3.04	0.085	0.120
F	5.08	5.33	0.200	0.210
H	18.29	18.54	0.720	0.730
J	0.10	0.15	0.004	0.006
K	10.29	11.17	0.405	0.440
L	3.81	4.06	0.150	0.160
N	3.81	4.31	0.150	0.170
Q	2.92	3.30	0.115	0.130
R	3.05	3.30	0.120	0.130
U	11.94	12.57	0.470	0.495

- STYLE 2:
 PIN 1. BASE
 2. COLLECTOR
 3. BASE
 4. EMITTER

**CASE 316-01
 ISSUE D**

Motorola reserves the right to make changes without further notice to any products herein. Motorola makes no warranty, representation or guarantee regarding the suitability of its products for any particular purpose, nor does Motorola assume any liability arising out of the application or use of any product or circuit, and specifically disclaims any and all liability, including without limitation consequential or incidental damages. "Typical" parameters which may be provided in Motorola data sheets and/or specifications can and do vary in different applications and actual performance may vary over time. All operating parameters, including "Typicals" must be validated for each customer application by customer's technical experts. Motorola does not convey any license under its patent rights nor the rights of others. Motorola products are not designed, intended, or authorized for use as components in systems intended for surgical implant into the body, or other applications intended to support or sustain life, or for any other application in which the failure of the Motorola product could create a situation where personal injury or death may occur. Should Buyer purchase or use Motorola products for any such unintended or unauthorized application, Buyer shall indemnify and hold Motorola and its officers, employees, subsidiaries, affiliates, and distributors harmless against all claims, costs, damages, and expenses, and reasonable attorney fees arising out of, directly or indirectly, any claim of personal injury or death associated with such unintended or unauthorized use, even if such claim alleges that Motorola was negligent regarding the design or manufacture of the part. Motorola and  are registered trademarks of Motorola, Inc. Motorola, Inc. is an Equal Opportunity/Affirmative Action Employer.

Mfax is a trademark of Motorola, Inc.

How to reach us:

USA/EUROPE/Locations Not Listed: Motorola Literature Distribution;
P.O. Box 5405, Denver, Colorado 80217. 303-675-2140 or 1-800-441-2447

JAPAN: Nippon Motorola Ltd.: SPD, Strategic Planning Office, 4-32-1,
Nishi-Gotanda, Shinagawa-ku, Tokyo 141, Japan. 81-3-5487-8488

Mfax™: RMFAX0@email.sps.mot.com – TOUCHTONE 602-244-6609
– US & Canada ONLY 1-800-774-1848

ASIA/PACIFIC: Motorola Semiconductors H.K. Ltd.; 8B Tai Ping Industrial Park,
51 Ting Kok Road, Tai Po, N.T., Hong Kong. 852-26629298

INTERNET: <http://motorola.com/sps>

