

ULTRAFAST POWER RECTIFIER DIODE

MAIN PRODUCT CHARACTERISTICS

$I_{F(AV)}$	2 x100 A
V_{RRM}	400 V
V_F (max)	1.4 V

FEATURES AND BENEFITS

- LOW CONDUCTION LOSSES
- NEGLIGIBLE SWITCHING LOSSES
- HIGH AVALANCHE CAPABILITY
- ISOLATED PACKAGE :
2500 V_{DC}
CAPACITANCE 42pF

DESCRIPTION

High current power rectifier diode suited for Switched Mode Power Supply and high frequency DC to DC converters.

Packaged in ISOTOP, this device is intended for use in a medium voltage high current applications such as **welding equipment and Telecom supplies.**

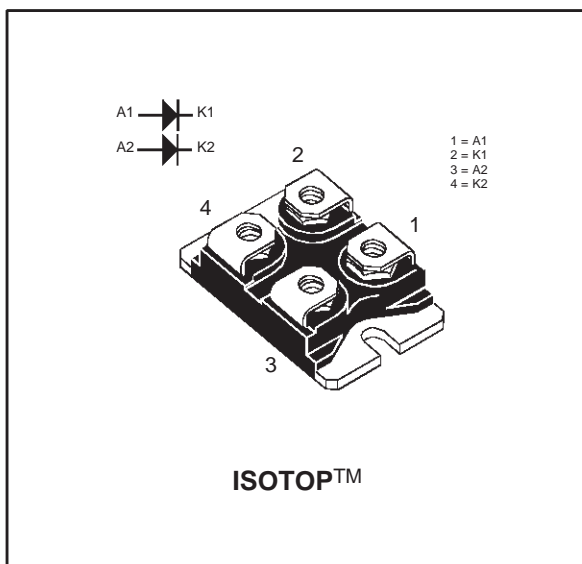

ABSOLUTE MAXIMUM RATING

Symbol	Parameter		Value	Unit
V_{RRM}	Repetitive peak reverse voltage		400	V
$I_{F(RMS)}$	RMS forward current		150	A
$I_{F(AV)}$	Average forward current	$T_c = 80^\circ\text{C}$ $\delta = 0.5$	100	A
I_{FSM}	Surge non repetitive forward current	$t_p = 10$ ms Sinusoidal	600	A
I_{FRM}	Repetitive peak forward current	$t_p @ 10 \mu\text{s}$	800	A
T_{stg}	Storage temperature range		- 40 to + 150	°C
T_j	Maximum junction temperature		150	°C

ISOTOP is a trademark of STMicroelectronics

BYT200PIV-400

THERMAL RESISTANCES

Symbol	Parameter		Value	Unit
R _{th(j-c)}	Junction to case	Per leg	0.55	°C/W
		Total	0.33	
R _{th(c)}		Coupling	0.1	

STATIC ELECTRICAL CHARACTERISTICS (per diode)

Symbol	Parameter	Tests Conditions		Min.	Typ.	Max.	Unit
I _R *	Reverse leakage current	T _j = 25°C	V _R = V _{RRM}			120	μA
		T _j = 100°C			4	12	mA
V _F **	Forward voltage drop	T _j = 25°C	I _F = 100 A			1.6	V
		T _j = 125°C	I _F = 100 A		0.95	1.4	

Pulse test : * tp = 5 ms, duty cycle < 2 %

** tp = 380 μs, duty cycle < 2%

RECOVERY CHARACTERISTICS

Symbol	Parameter	Test Conditions		Min.	Typ.	Max.	Unit
t _{rr}	Reverse recovery time	I _F =0.5A I _R =1A I _{rr} =0.25A I _F =1A dI/dt= -50A/μs V _r =30V			55	100	ns
I _{RM}	Reverse recovery current	dI _F /dt=-200A/μs V _R =400V	T _j =125°C I _F =100A			40	A
S factor	Softness factor	dI _F /dt=-200A/μs V _R =400V	T _j =125°C I _F =100A		0.25		
t _{fr}	Forward recovery time	I _F =100A	dI _F /dt=500A/μs Measured at 1.1 x V _F max.			500	ns
V _{FP}	Peak forward voltage	T _j =25°C				12	V

To evaluate the conduction losses use the following equation :

$$P = 0.8 \times I_{F(AV)} + 0.00228 \times I_{F(RMS)}^2$$

Fig. 1: Average forward power dissipation versus average forward current (per diode).

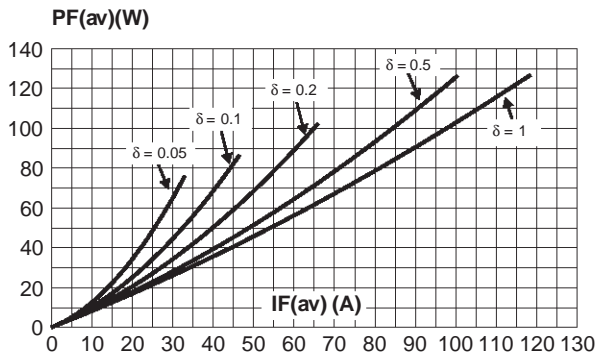

Fig. 2: Peak current versus form factor (per diode).

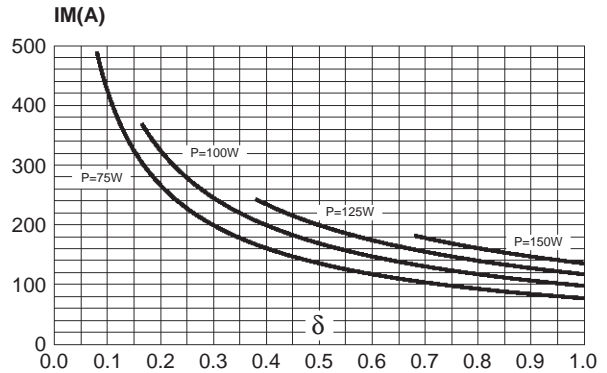

Fig. 3: Average forward current versus ambient temperature ($\delta = 0.5$, per diode).

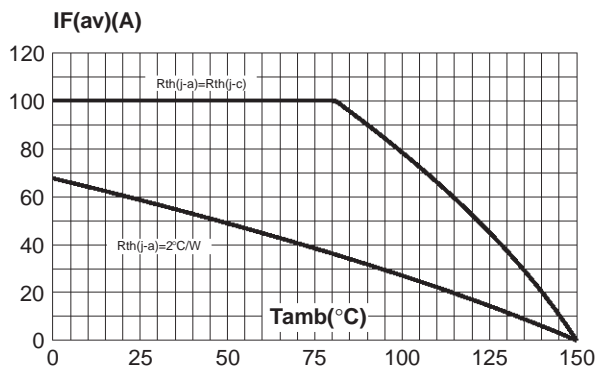

Fig. 4: Non repetitive surge peak forward current versus overload duration (per diode).

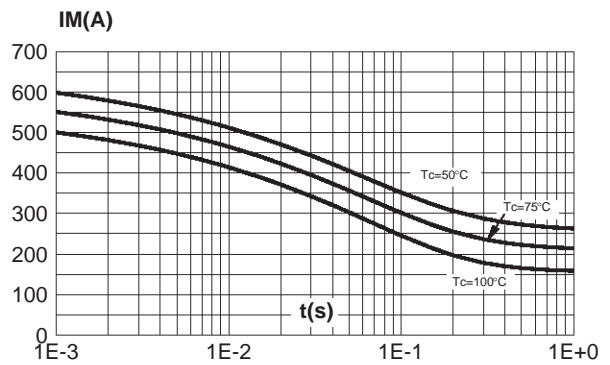

Fig. 5: Relative variation of thermal impedance junction to case versus pulse duration (per diode).

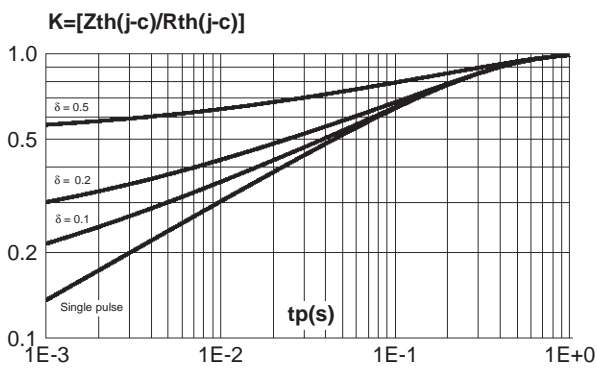

Fig. 6: Forward voltage drop versus forward current (maximum values, per diode).

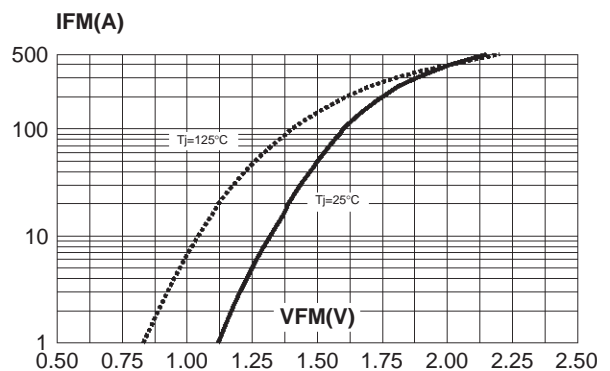

Fig. 7: Junction capacitance versus reverse voltage applied (typical values, per diode).

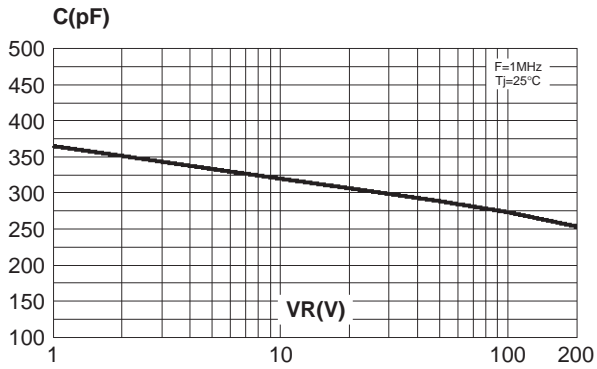

Fig. 8: Recovery charges versus dIF/dt (per diode).

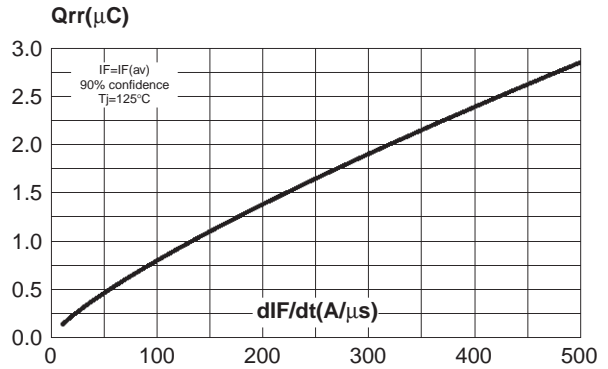

Fig. 9: Recovery current versus dIF/dt (per diode).

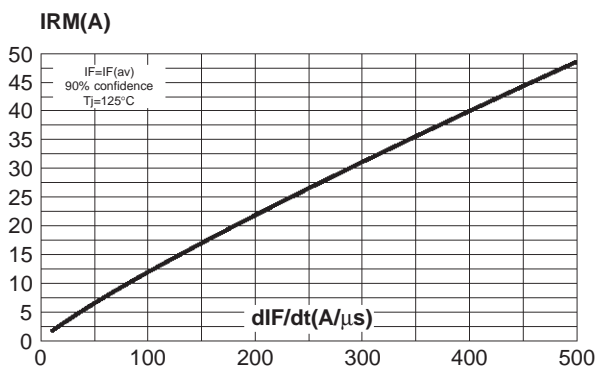

Fig. 10: Transient peak forward voltage versus dIF/dt (per diode).

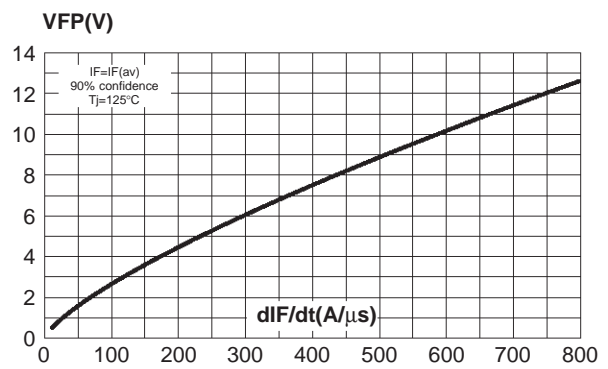
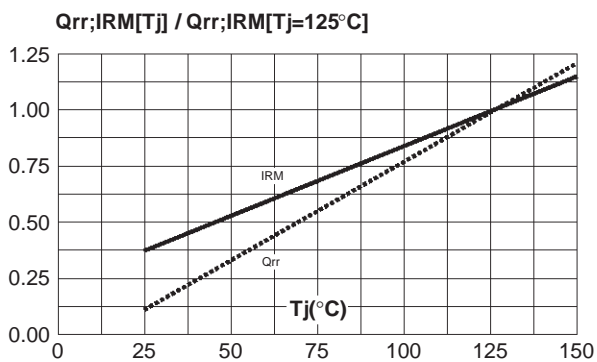
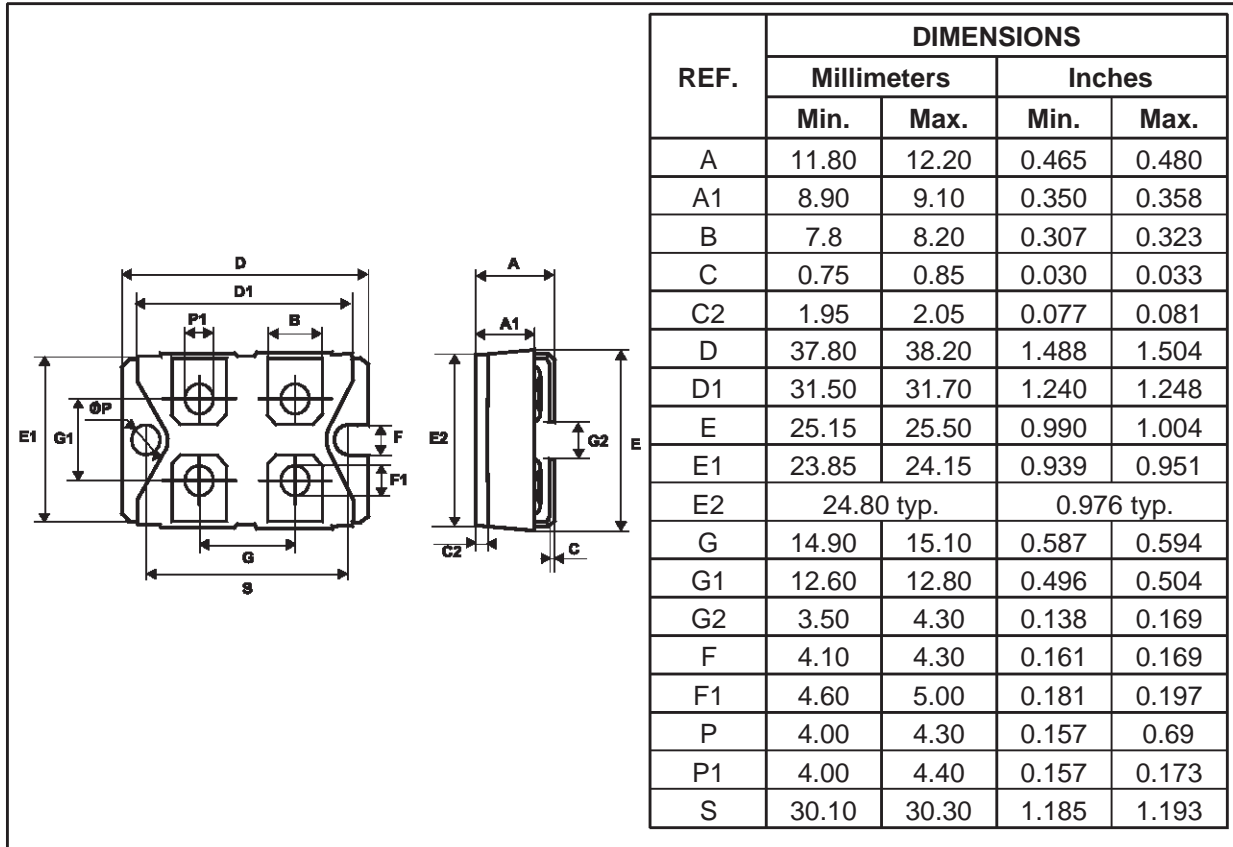

Fig. 11: Dynamic parameters versus junction temperature.



PACKAGE MECHANICAL DATA
ISOTOP



• Epoxy meets UL94, V0

Information furnished is believed to be accurate and reliable. However, STMicroelectronics assumes no responsibility for the consequences of use of such information nor for any infringement of patents or other rights of third parties which may result from its use. No license is granted by implication or otherwise under any patent or patent rights of STMicroelectronics. Specifications mentioned in this publication are subject to change without notice. This publication supersedes and replaces all information previously supplied. STMicroelectronics products are not authorized for use as critical components in life support devices or systems without express written approval of STMicroelectronics.

The ST logo is a registered trademark of STMicroelectronics
© 2000 STMicroelectronics - Printed in Italy - All rights reserved.

STMicroelectronics GROUP OF COMPANIES
Australia - Brazil - China - Finland - France - Germany - Hong Kong - India - Italy - Japan - Malaysia
Malta - Morocco - Singapore - Spain - Sweden - Switzerland - United Kingdom - U.S.A.

<http://www.st.com>

