

**Rectifier diodes  
ultrafast, rugged**

**BYW29E series**

**FEATURES**

- Low forward volt drop
- Fast switching
- Soft recovery characteristic
- Reverse surge capability
- High thermal cycling performance
- Low thermal resistance

**SYMBOL**

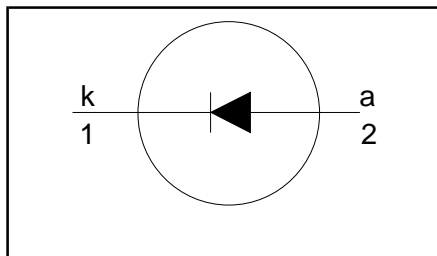

**QUICK REFERENCE DATA**

$V_R = 150\text{ V} / 200\text{ V}$
$V_F \leq 0.895\text{ V}$
$I_{F(AV)} = 8\text{ A}$
$I_{RRM} \leq 0.2\text{ A}$
$t_{tr} \leq 25\text{ ns}$

**GENERAL DESCRIPTION**

Ultra-fast, epitaxial rectifier diodes intended for use as output rectifiers in high frequency switched mode power supplies.

The BYW29E series is supplied in the conventional leaded SOD59 (TO220AC) package.

**PINNING**

PIN	DESCRIPTION
1	cathode
2	anode
tab	cathode

**SOD59 (TO220AC)**

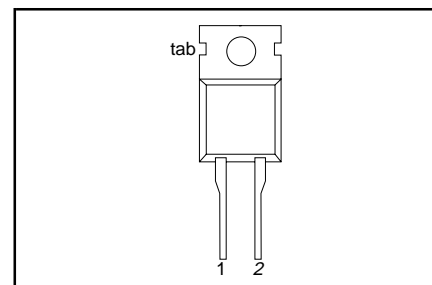

**LIMITING VALUES**

Limiting values in accordance with the Absolute Maximum System (IEC 134)

SYMBOL	PARAMETER	CONDITIONS	MIN.	MAX.		UNIT
$V_{RRM}$	Peak repetitive reverse voltage	BYW29E	-	-150	-200	V
$V_{RWM}$	Working peak reverse voltage		-	150	200	V
$V_R$	Continuous reverse voltage		-	150	200	V
$I_{F(AV)}$	Average rectified forward current	square wave; $\delta = 0.5$ ; $T_{mb} \leq 128\text{ }^\circ\text{C}$	-	8		A
$I_{FRM}$	Repetitive peak forward current	square wave; $\delta = 0.5$ ; $T_{mb} \leq 128\text{ }^\circ\text{C}$	-	16		A
$I_{FSM}$	Non-repetitive peak forward current	$t = 10\text{ ms}$	-	80		A
		$t = 8.3\text{ ms}$	-	88		A
$I_{RRM}$	Peak repetitive reverse surge current	sinusoidal; with reapplied $V_{RRM(max)}$ $t_p = 2\text{ }\mu\text{s}$ ; $\delta = 0.001$	-	0.2		A
$I_{RSM}$	Peak non-repetitive reverse surge current	$t_p = 100\text{ }\mu\text{s}$	-	0.2		A
$T_j$	Operating junction temperature		-	150		$^\circ\text{C}$
$T_{stg}$	Storage temperature		-40	150		$^\circ\text{C}$

**ESD LIMITING VALUE**

SYMBOL	PARAMETER	CONDITIONS	MIN.	MAX.	UNIT
$V_C$	Electrostatic discharge capacitor voltage	Human body model; $C = 250\text{ pF}$ ; $R = 1.5\text{ k}\Omega$	-	8	kV

---

**Rectifier diodes  
ultrafast, rugged**

---

**BYW29E series****THERMAL RESISTANCES**

SYMBOL	PARAMETER	CONDITIONS	MIN.	TYP.	MAX.	UNIT
$R_{th\ j-mb}$	Thermal resistance junction to mounting base	in free air	-	-	2.7	K/W
$R_{th\ j-a}$	Thermal resistance junction to ambient		-	60	-	K/W

**ELECTRICAL CHARACTERISTICS** $T_j = 25\text{ }^\circ\text{C}$  unless otherwise specified

SYMBOL	PARAMETER	CONDITIONS	MIN.	TYP.	MAX.	UNIT
$V_F$	Forward voltage	$I_F = 8\text{ A}$ ; $T_j = 150\text{ }^\circ\text{C}$	-	0.8	0.895	V
		$I_F = 8\text{ A}$	-	0.92	1.05	V
		$I_F = 20\text{ A}$	-	1.1	1.3	V
$I_R$	Reverse current	$V_R = V_{RWM}$	-	2	10	$\mu\text{A}$
		$V_R = V_{RWM}$ ; $T_j = 100\text{ }^\circ\text{C}$	-	0.2	0.6	mA
$Q_{rr}$	Reverse recovered charge	$I_F = 2\text{ A}$ ; $V_R \geq 30\text{ V}$ ; $-di_F/dt = 20\text{ A}/\mu\text{s}$	-	4	11	nC
$t_{rr1}$	Reverse recovery time	$I_F = 1\text{ A}$ ; $V_R \geq 30\text{ V}$ ; $-di_F/dt = 100\text{ A}/\mu\text{s}$	-	20	25	ns
$t_{rr2}$	Reverse recovery time	$I_F = 0.5\text{ A}$ to $I_R = 1\text{ A}$ ; $I_{rec} = 0.25\text{ A}$	-	15	20	ns
$V_{fr}$	Forward recovery voltage	$I_F = 1\text{ A}$ ; $di_F/dt = 10\text{ A}/\mu\text{s}$	-	1	-	V

Rectifier diodes  
ultrafast, rugged

BYW29E series

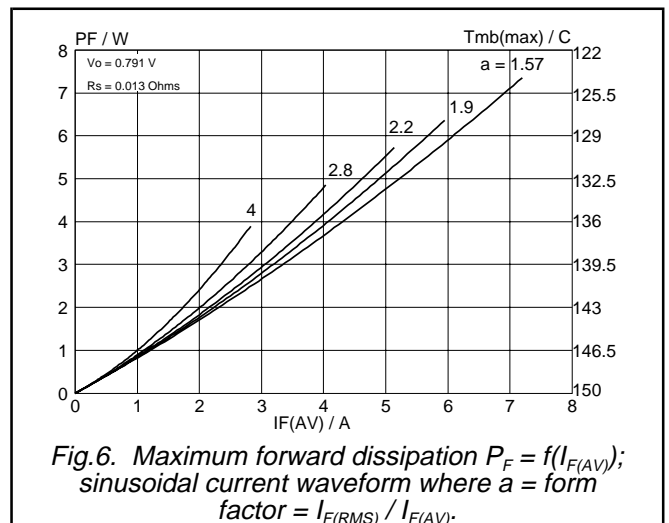
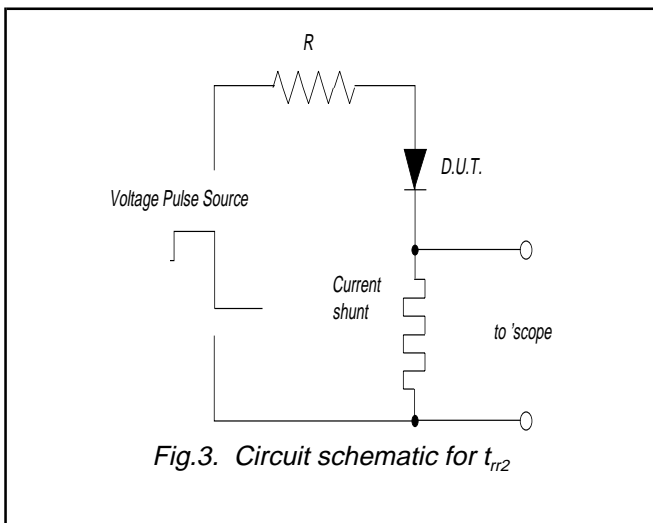
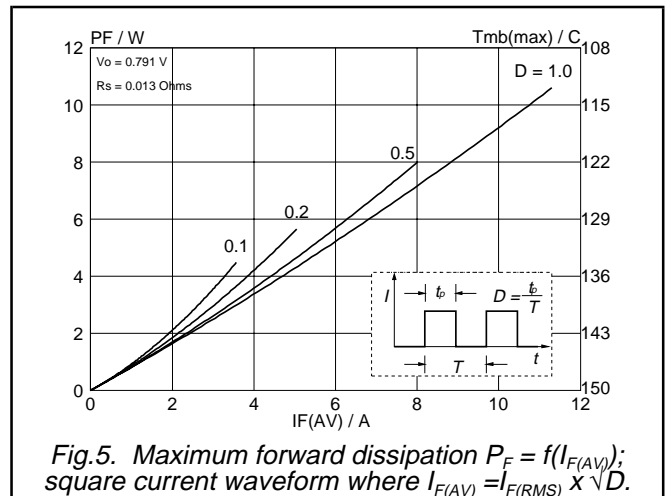
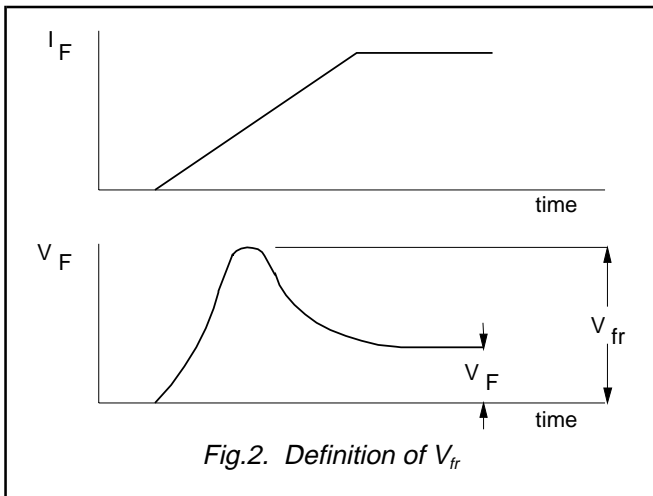
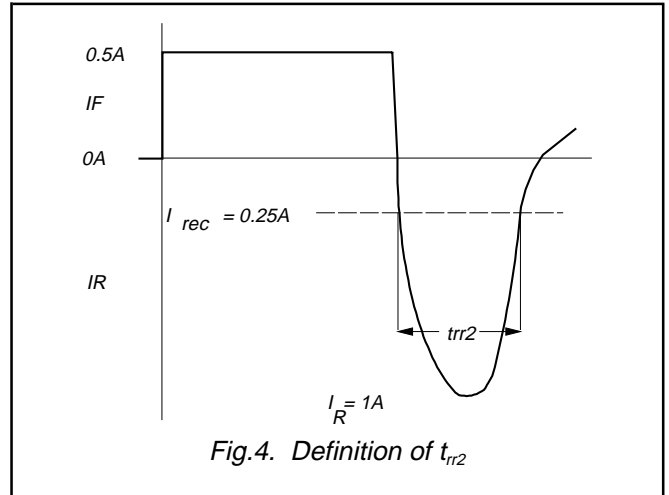
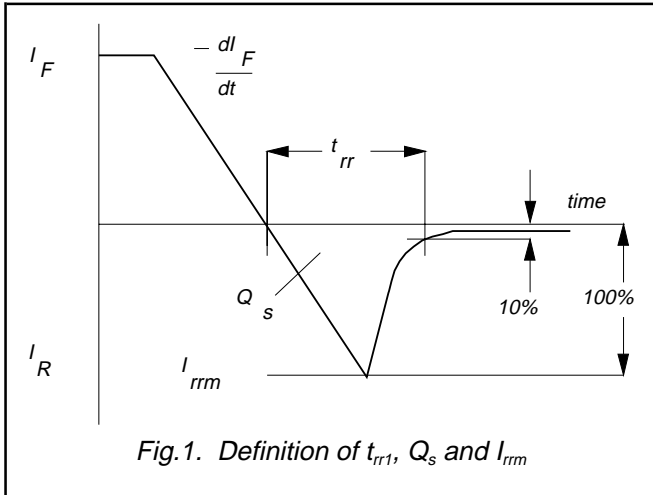

Rectifier diodes  
ultrafast, rugged

BYW29E series

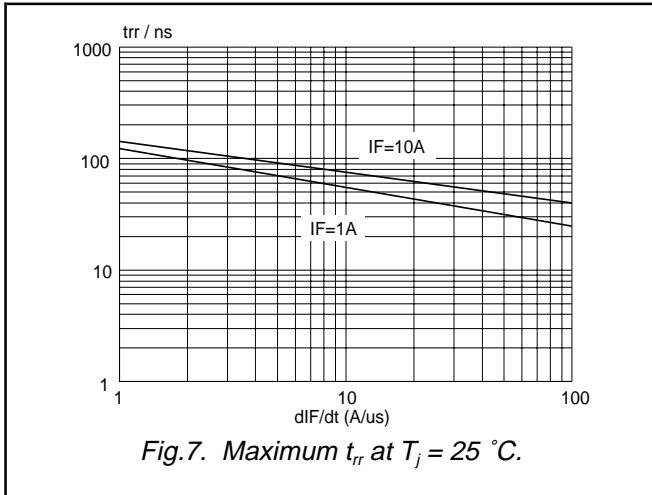

Fig.7. Maximum  $t_{rr}$  at  $T_j = 25^\circ C$ .

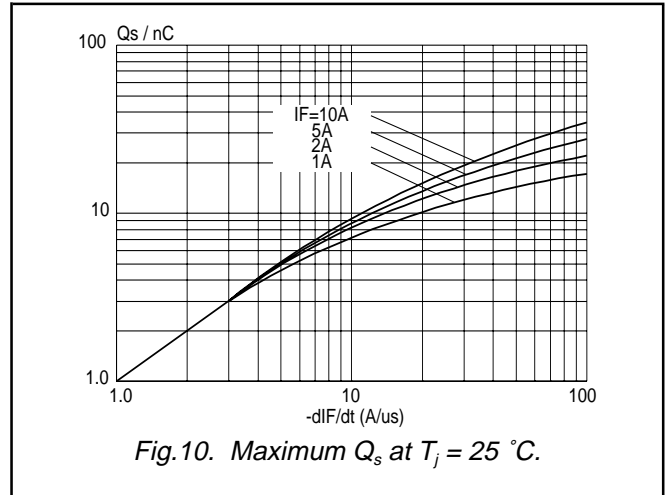

Fig.10. Maximum  $Q_s$  at  $T_j = 25^\circ C$ .

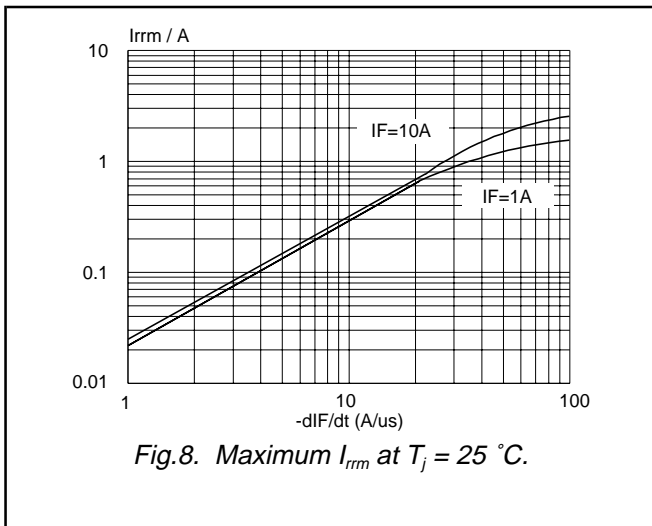

Fig.8. Maximum  $I_{rrm}$  at  $T_j = 25^\circ C$ .

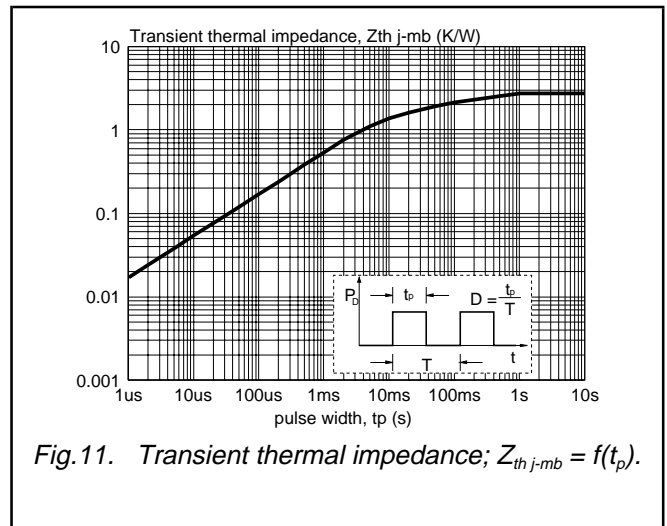

Fig.11. Transient thermal impedance;  $Z_{th j-mb} = f(t_p)$ .

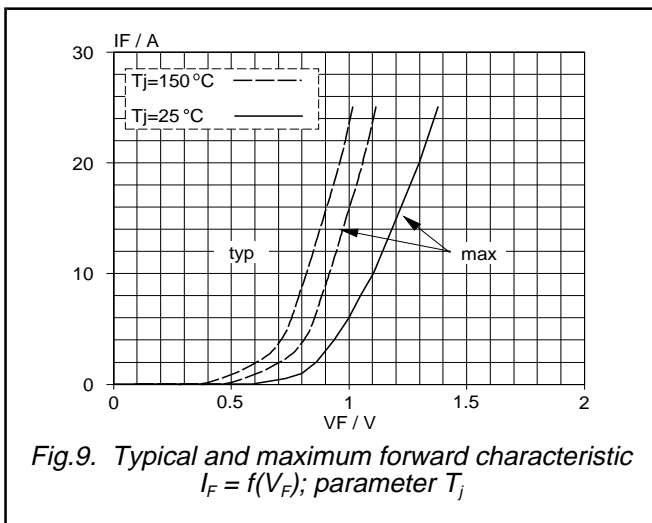
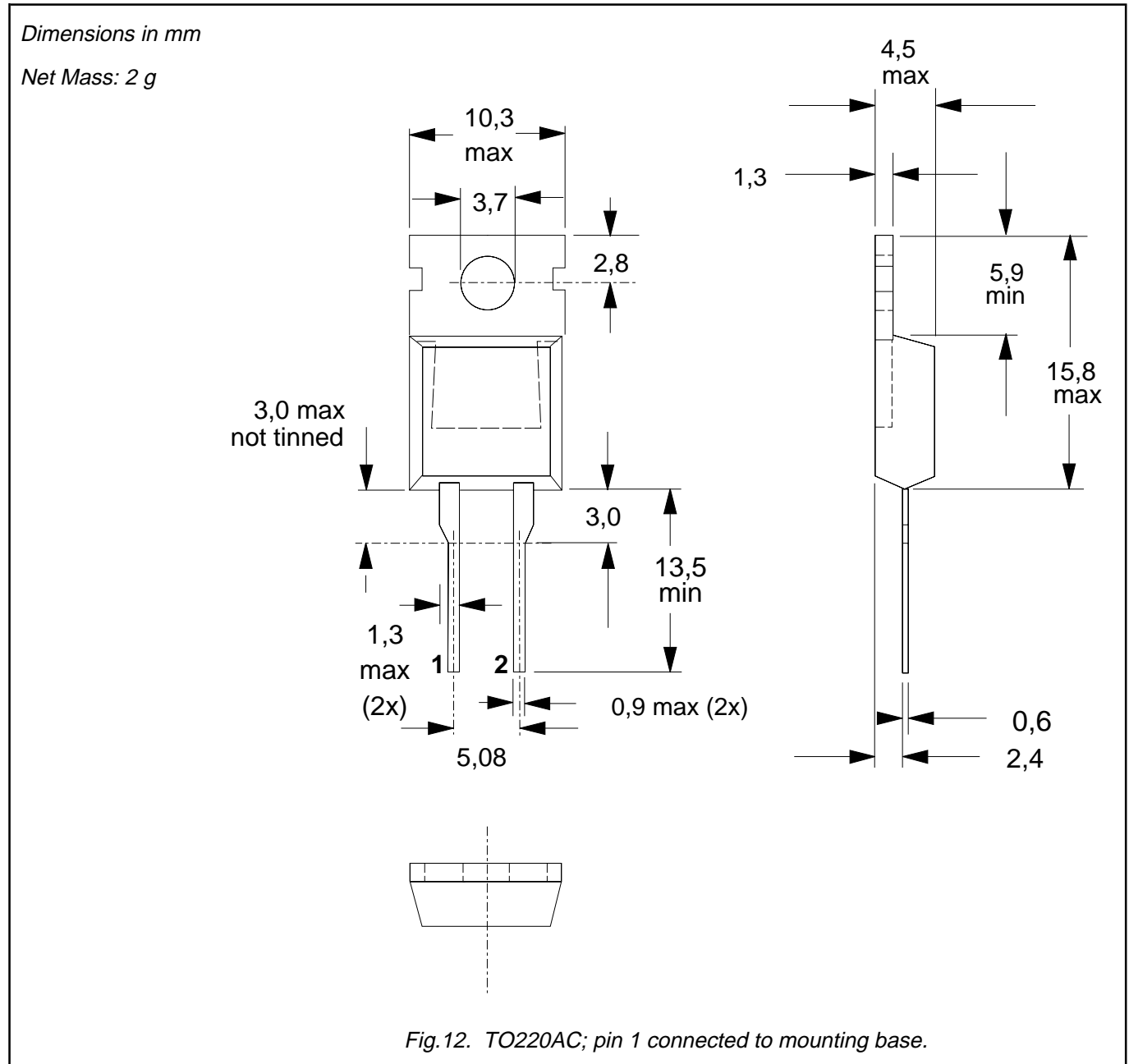

Fig.9. Typical and maximum forward characteristic  $I_F = f(V_F)$ ; parameter  $T_j$

Rectifier diodes  
ultrafast, rugged

BYW29E series

**MECHANICAL DATA**



**Notes**

1. Refer to mounting instructions for TO220 envelopes.
2. Epoxy meets UL94 V0 at 1/8".

Rectifier diodes  
ultrafast, rugged

BYW29E series

## DEFINITIONS

<b>Data sheet status</b>	
Objective specification	This data sheet contains target or goal specifications for product development.
Preliminary specification	This data sheet contains preliminary data; supplementary data may be published later.
Product specification	This data sheet contains final product specifications.
<b>Limiting values</b>	
Limiting values are given in accordance with the Absolute Maximum Rating System (IEC 134). Stress above one or more of the limiting values may cause permanent damage to the device. These are stress ratings only and operation of the device at these or at any other conditions above those given in the Characteristics sections of this specification is not implied. Exposure to limiting values for extended periods may affect device reliability.	
<b>Application information</b>	
Where application information is given, it is advisory and does not form part of the specification.	
© Philips Electronics N.V. 1998	
All rights are reserved. Reproduction in whole or in part is prohibited without the prior written consent of the copyright owner.	
The information presented in this document does not form part of any quotation or contract, it is believed to be accurate and reliable and may be changed without notice. No liability will be accepted by the publisher for any consequence of its use. Publication thereof does not convey nor imply any license under patent or other industrial or intellectual property rights.	

## LIFE SUPPORT APPLICATIONS

These products are not designed for use in life support appliances, devices or systems where malfunction of these products can be reasonably expected to result in personal injury. Philips customers using or selling these products for use in such applications do so at their own risk and agree to fully indemnify Philips for any damages resulting from such improper use or sale.