

All Band TV Tuner IC (VHF-CATV-UHF)

Description

The CXA3025N is a single chip TV tuner IC which performs as a mixer, oscillator for UHF and VHF-CATV bands. An IF amplifier is also provided.

This IC adopts a 24-pin SSOP package (0.8mm pitch) in response to the trend towards miniaturizing the tuner and automatic IC mounting.

Features

- Low noise figure
- Superior cross modulation
- Low spurious
- Stable oscillating characteristics
- Local oscillator output for PLL
- Double tune filter connectable to MIX output
- Low thermal resistance package

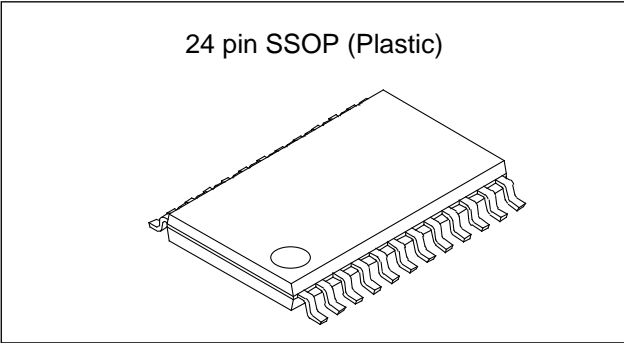

Absolute Maximum Ratings (Ta = 25°C)

- Supply voltage Vcc 10.5 V
- Storage temperature Tstg -65 to +150 °C
- Allowable power dissipation Pd 1200 mW (when mounted on a board)

Structure

Bipolar silicon monolithic IC

Operating Conditions

- Supply voltage Vcc 9.0 ± 0.9 V
- Operating temperature Topr -20 to +75 °C

Applications

- TV tuner
- CATV tuner
- VCR tuner

Block Diagram and Pin Configuration (Top View)

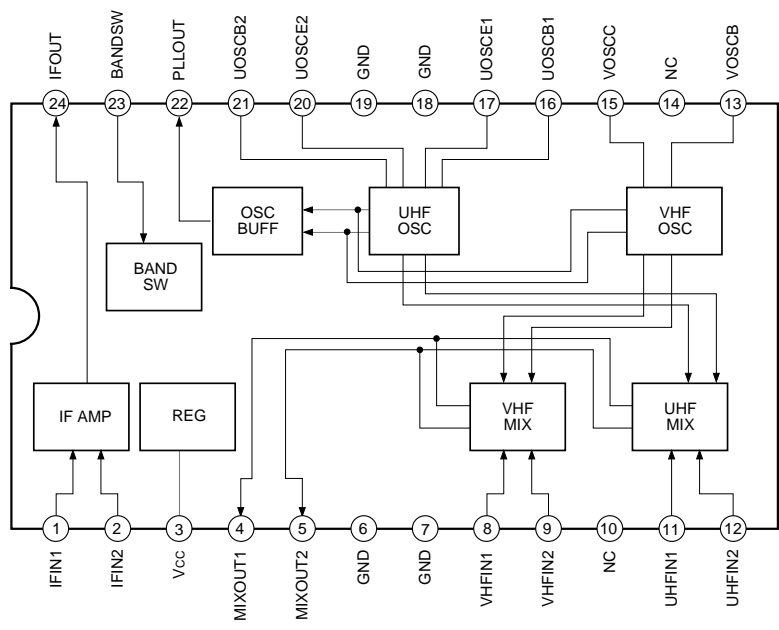

Sony reserves the right to change products and specifications without prior notice. This information does not convey any license by any implication or otherwise under any patents or other right. Application circuits shown, if any, are typical examples illustrating the operation of the devices. Sony cannot assume responsibility for any problems arising out of the use of these circuits.

Pin Description and Equivalent Circuit

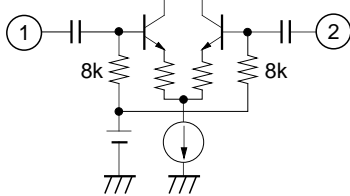
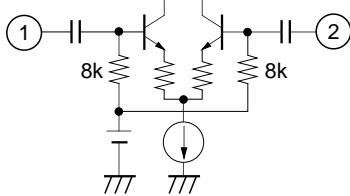
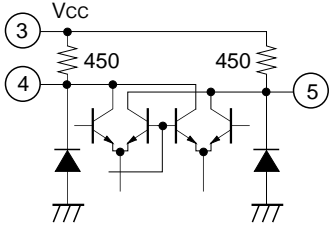
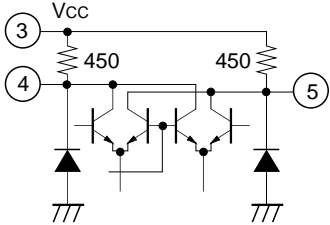
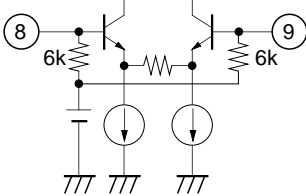
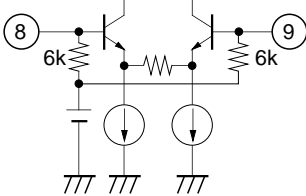
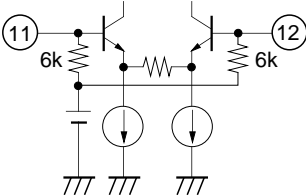
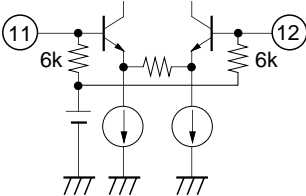
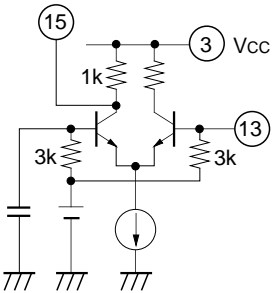
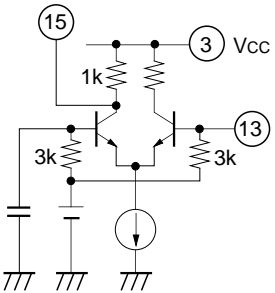
Pin No.	Symbol	Pin voltage typ. (V)	Equivalent circuit	Description
1	IFIN1	During VHF reception —		IF amplifier inputs.
		During UHF reception —		
2	IFIN2	—		IF amplifier inputs.
		—		
3	Vcc	9.0		Power supply.
4	MIXOUT1	7.4		Mixer outputs.
		7.2		
5	MIXOUT2	7.4		Mixer outputs.
		7.2		
8	VHFIN1	3.2		VHF inputs. Normally a capacitor is connected at Pin 8 to GND and Pin 9 is used for input.
		3.4		
9	VHFIN2	3.2		VHF inputs. Normally a capacitor is connected at Pin 8 to GND and Pin 9 is used for input.
		3.4		
10	NC			No connected.
11	UHFIN1	3.4		UHF inputs. Balanced input to Pins 11 and 12 or a capacitor is connected at Pin 11 to GND and Pin 12 is used for input.
		3.2		
12	UHFIN2	3.4		UHF inputs. Balanced input to Pins 11 and 12 or a capacitor is connected at Pin 11 to GND and Pin 12 is used for input.
		3.2		
13	VOSCB	3.3		VHF oscillators.
		3.5		
15	VOSCC	6.3		VHF oscillators.
		9.0		
14	NC			No connected.

Pin No.	Symbol	Pin voltage typ. (V)	Equivalent circuit	Description
16	UOSCB1	3.5		UHF oscillators.
		3.3		
17	UOSCE1	3.0		
		2.5		
20	UOSCE2	3.0		
		2.5		
21	UOSCB2	3.5		
		3.3		
6, 7 18 19	GND	0		GNDs.
22	PLLOUT	5.8		PLL IC oscillator output.
		5.7		
23	BANDSW	0		Band switching. UHF operation when 3V or more voltage is applied externally, and VHF operation when OPEN or 0.5V or less voltage is applied.
		3.0		
24	IFOUT	Under VHF operation : 4.5		IF output.
		Under UHF operation : 4.5		

Electrical Characteristics

See Electrical Characteristics Measurement Circuit. (Ta = 25°C, Vcc = 9V)

Item	Symbol	Measurement conditions	Min.	Typ.	Max.	Unit
Circuit current	IccV	VHF operation; no signal	38	53	63	mA
	IccU	UHF operation; no signal	37	51	62	mA
Conversion gain*1	CG1	VHF operation; fRF = 55MHz; Input level -40dBm	17	20	23	dB
	CG2	VHF operation; fRF = 360MHz; Input level -40dBm	18	21	24	dB
	CG3	UHF operation; fRF = 360MHz; Input level -40dBm	23	26	29	dB
	CG4	UHF operation; fRF = 800MHz; Input level -40dBm	23	26	29	dB
Noise figure*1 *2	NF1	VHF operation; fRF = 55MHz		13	16	dB
	NF2	VHF operation; fRF = 360MHz		12	15	dB
	NF3	UHF operation; fRF = 360MHz		9	13	dB
	NF4	UHF operation; fRF = 800MHz		9	13	dB
1% cross modulation *1 *3	CM1	VHF operation; fd = 55MHz; fUD = ±12MHz	99	102		dBμ
	CM2	VHF operation; fd = 360MHz; fUD = ±12MHz	97	100		dBμ
	CM3	UHF operation; fd = 360MHz; fUD = ±12MHz	91	94		dBμ
	CM4	UHF operation; fd = 800MHz; fUD = ±12MHz	89	92		dBμ
Max. output power	Pomax (sat)	50Ω load	+8	+10		dBm
Switch ON drift*4	Δfsw1	VHF operation; fosc = 100MHz			±200	kHz
	Δfsw2	VHF operation; fosc = 405MHz			±300	kHz
	Δfsw3	UHF operation; fosc = 405MHz			±300	kHz
	Δfsw4	UHF operation; fosc = 845MHz			±300	kHz
+B drift*5	Δfst1	VHF operation; fosc = 100MHz			±100	kHz
	Δfst2	VHF operation; fosc = 405MHz			±200	kHz
	Δfst3	UHF operation; fosc = 405MHz			±150	kHz
	Δfst4	UHF operation; fosc = 845MHz			±150	kHz
PLL OUT output power	PoscV	VHF operation; 50Ω load	-20	-10		dBm
	PoscU	UHF operation; 50Ω load	-20	-10		dBm
Band switch voltage	VswV	VHF operation	0		0.5	V
	VswU	UHF operation	3		10.5	V

*1 Measured value for untuned inputs.

*2 Noise figure is the directly-read value of the NF meter in DSB.

*3 Desired signal (fd) input level is -33dBm. Undesired signal (fUD) is 100kHz, 30% AM at ±12MHz. The measurement value is the undesired signal level, measured with a spectrum analyzer at S/I = 46dB.

*4 Frequency variation from 3 seconds to 3 minutes after switch ON.

*5 Frequency variation when Vcc = 9V ± 5% variation.

Electrical Characteristics Measurement Circuit

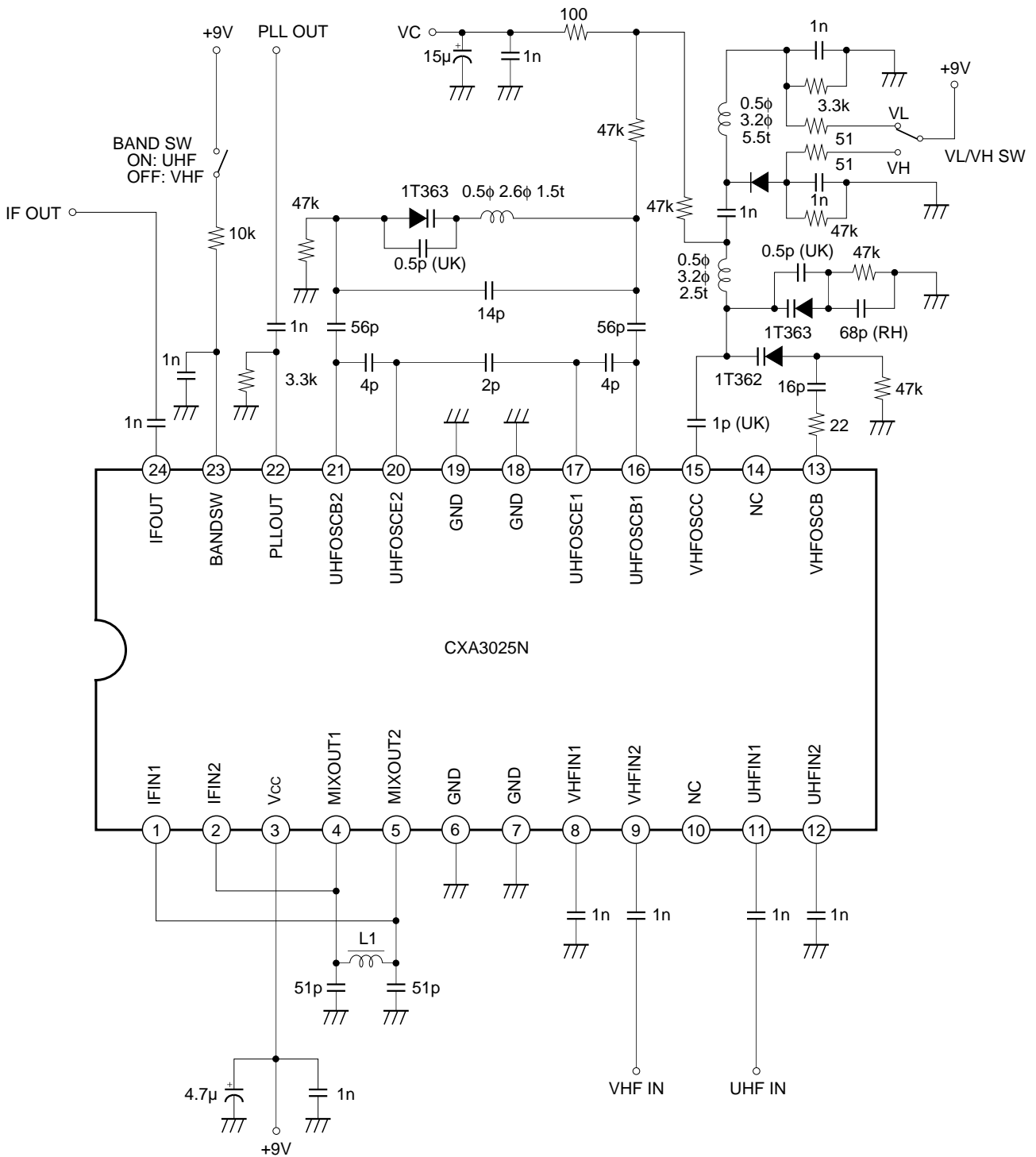

Inductance constant
 L without indication is an air-core coil of 0.5mm diameter.

Application Circuit

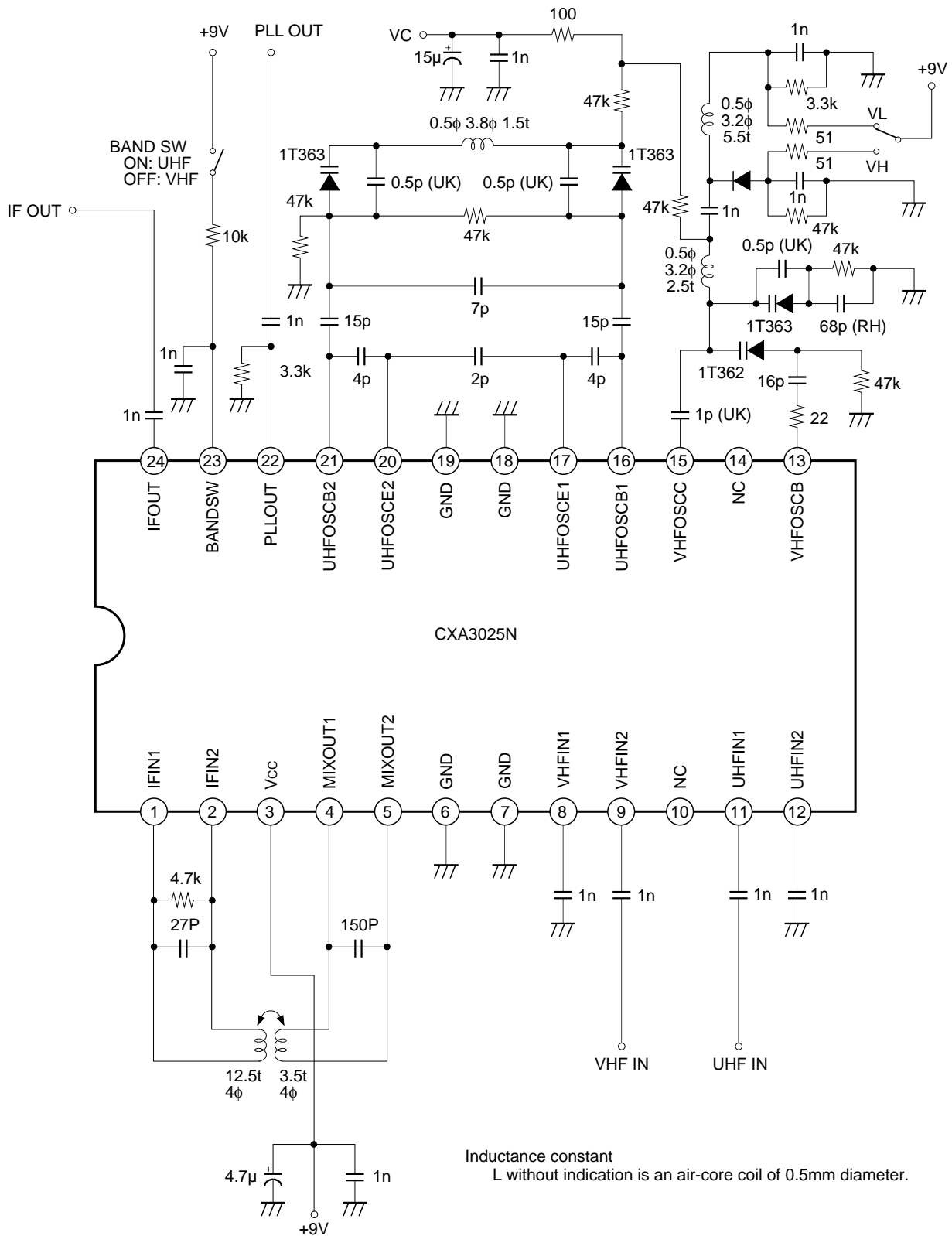

Circuit when using two varicap diodes for the UHF oscillator, improving the oscillator stability and frequency variable range, and using a double tune circuit for the IF tune circuit.

Application circuits shown are typical examples illustrating the operation of the devices. Sony cannot assume responsibility for any problems arising out of the use of these circuits or for any infringement of third party patent and other right due to same.

Description of Operation (See Electrical Characteristics Measurement Circuit.)**VHF oscillator circuit**

This is a differential amplifier type oscillator circuit with an output at Pin 15 and an input at Pin 13.

Connect an LC resonance circuit comprising a varicap diode to Pin 15 through a coupling capacitor, and input the positive feedback from this resonance circuit to Pin 13 through a feedback capacitor to execute oscillation. Note that if the capacitance across Pins 13 and 15 is too large, positive feedback may be applied via a parasitic capacitance causing undesired stray oscillation. The resistance connected to Pin 13 is for preventing parasitic oscillation, and is inserted to ensure stable oscillation.

VHF mixer circuit

The mixer circuit adopts a common emitter type double-balanced mixer with little leakage of the local oscillation signal. The RF signal is input to Pins 8 and 9. During normal use, the RF signal is input to one pin while the other pin is connected to GND. The RF signal is converted to IF frequency by the signal supplied from the oscillator and then output to Pins 4 and 5.

UHF oscillator circuit

The UHF oscillator is formed from two collector-grounded Colpitts oscillators, and oscillation is provided at the differential input through an LC resonance circuit comprising a varicap diode. An LC resonance circuit comprising a varicap diode is connected across Pins 16, 17, 20 and 21.

UHF mixer circuit

Like the VHF mixer, the UHF mixer adopts a double-balanced mixer. The RF signal is input to Pins 11 and 12. There is a balanced input at the differential from both edges of the secondary coil of the pre-stage double tune circuit, or an unbalanced input to Pin 11 with a capacitor connected at Pin 12 to GND. Otherwise, the conditions and usage are the same as those for the VHF mixer circuit.

IF amplifier circuit

The signal frequency converted by the mixer is output from Pins 4 and 5, and input to IF input pins 1 and 2 through an external IF tune circuit. For the IF tune circuit, a single tune circuit like the electrical characteristics measurement circuit or a double tune circuit can be connected. The signal amplified by the IF amplifier is output from Pin 24. The output impedance is approximately 75Ω.

Also, the input block of the IF amplifier has a built-in coupling capacitor, and direct connection with the mixer output is possible.

U/V switch circuit

UHF operation is chosen by applying voltage of 3V or more to Pin 23; VHF operation for 0V or OPEN.

PLL oscillator signal output circuit

The oscillation signal is output to Pin 22 (PLLOUT) through a buffer amplifier. The resistance connected to the output pin is used to adjust the current flowing to the buffer amplifier. The resistance value is adjusted depending on the connected load, and output distortion can be minimized.

Notes on Operation

Care should be taken for grounding, etc. when placing external parts as high operating frequencies are present. In addition, since the GND pins (Pins 6, 7, 18 and 19) also serve as heat dissipation pins, care should be taken to prevent heat problems.

Care should also be taken to prevent electrostatic damage to high frequency I/O pins.

Example of Representative Characteristics

Conversion gain vs. Reception frequency (Untuned input)

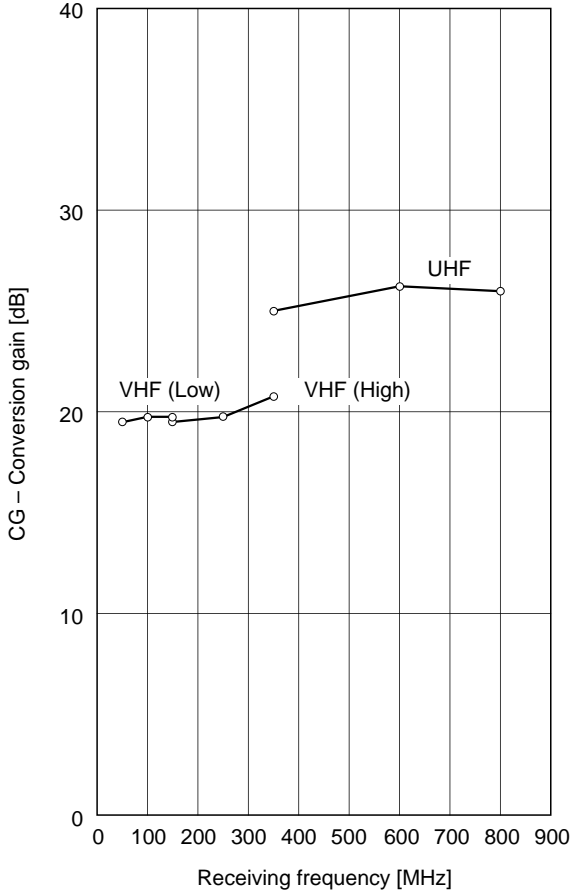

Next adjacent cross modulation vs. Reception frequency (Untuned input)

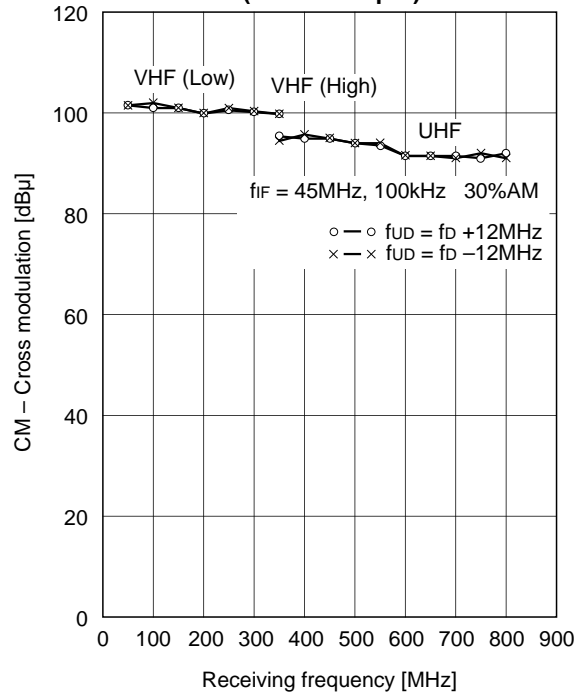

I/O characteristics (Untuned input)

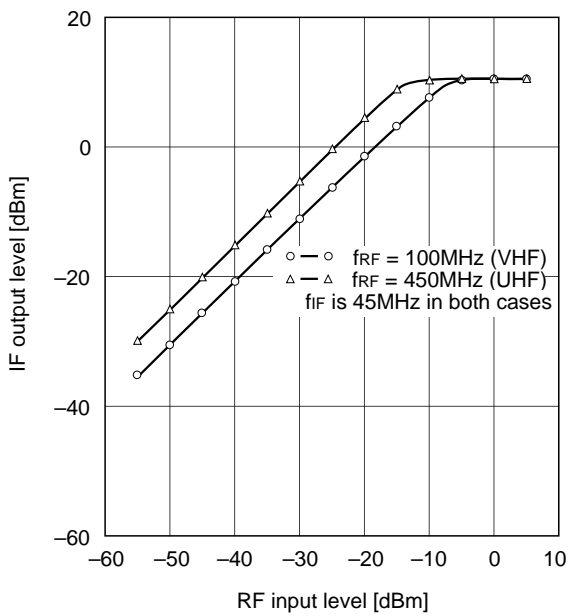

Noise figure vs. Reception frequency (Untuned input, in DSB)

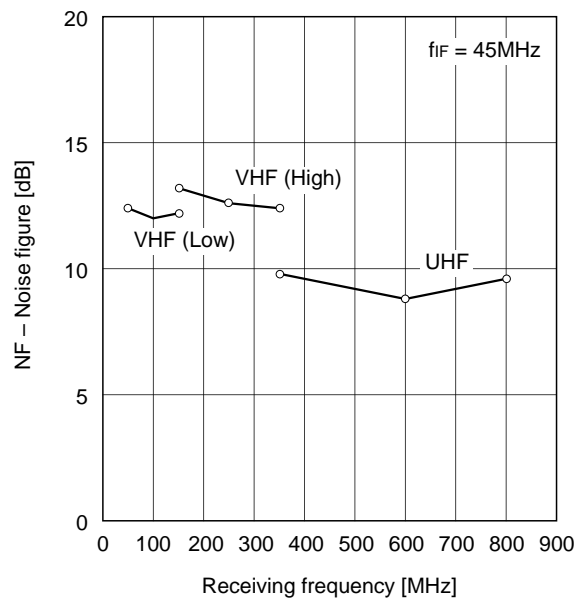

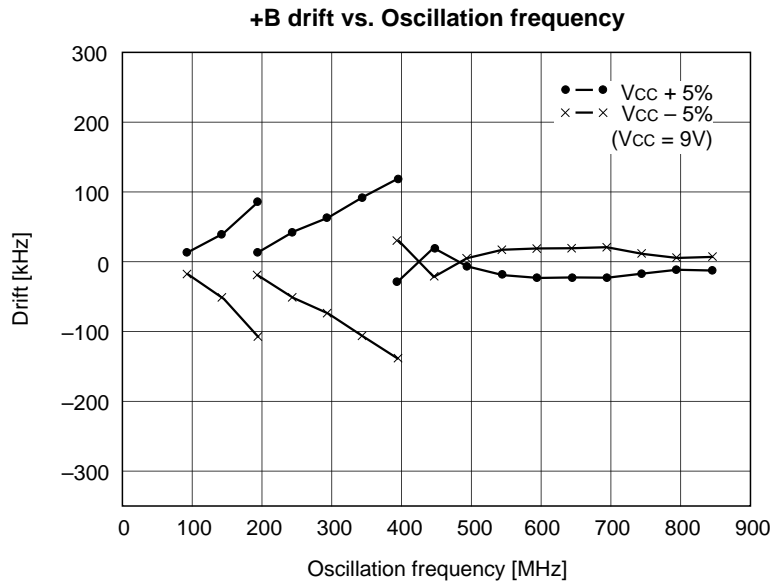
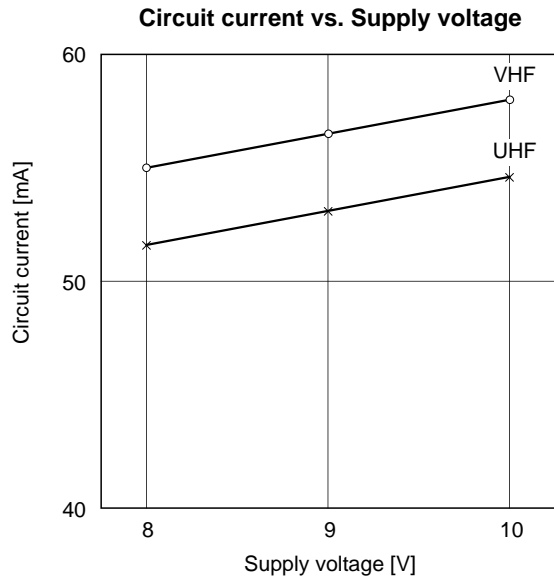

PLLOUT level (fundamental harmonic and secondary higher harmonic) vs. Oscillation frequency

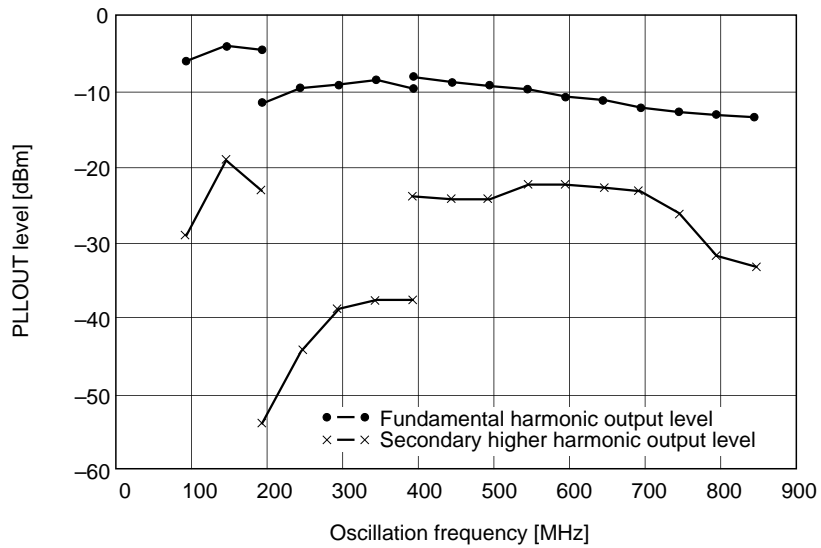

VHF Input Impedance

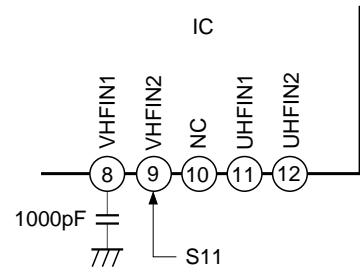
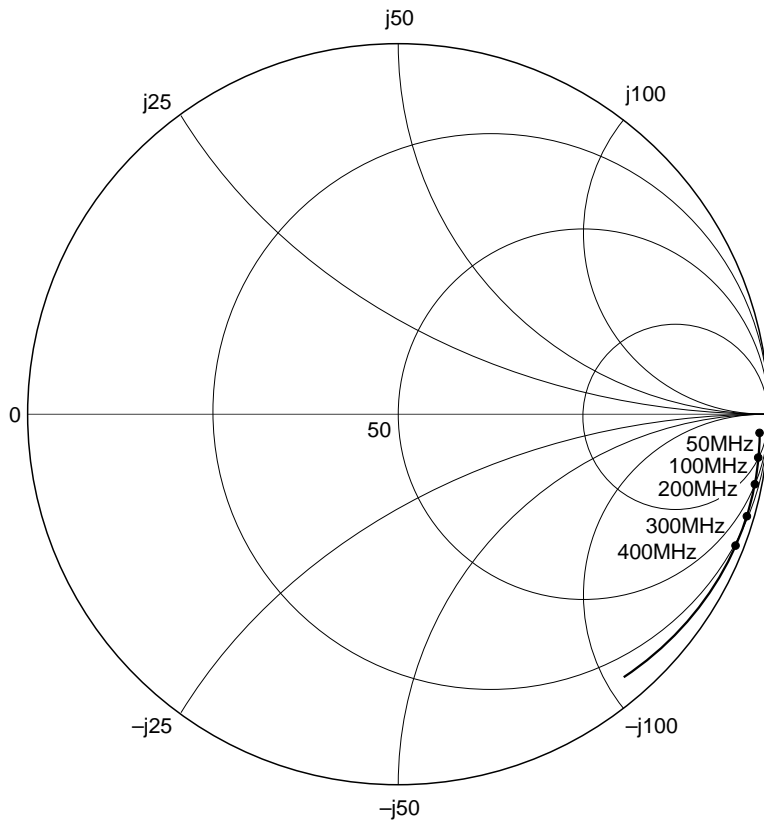

UHF Input Impedance

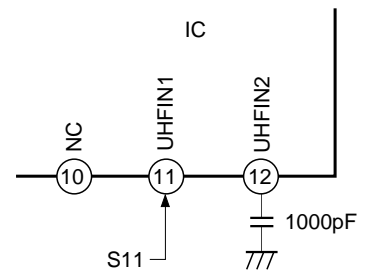
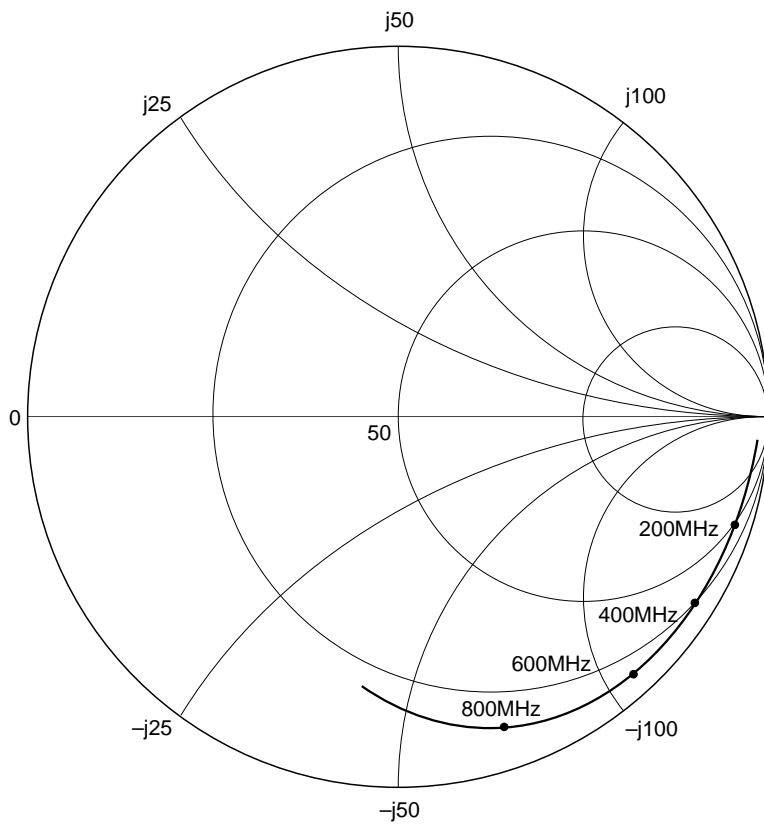

IF OUT Impedance

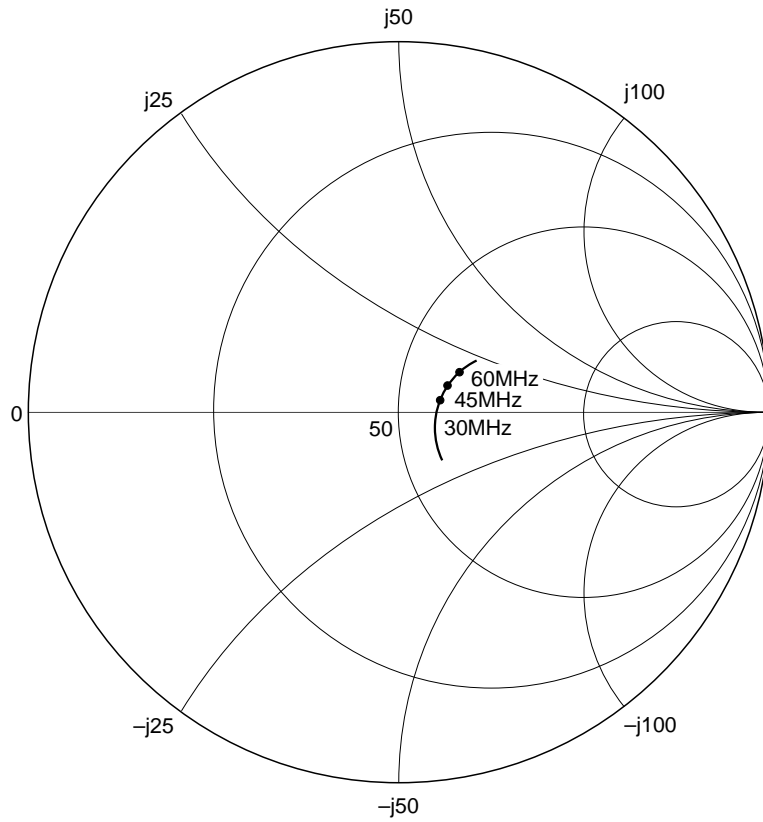

PLL OUT Impedance

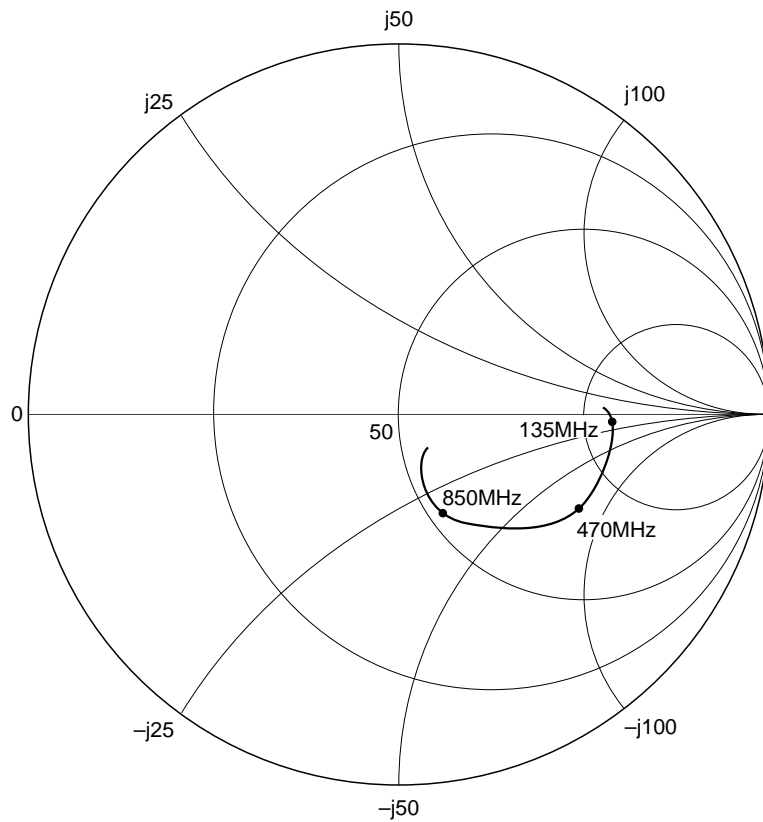

Package Outline

Unit: mm

24PIN SSOP (PLASTIC)

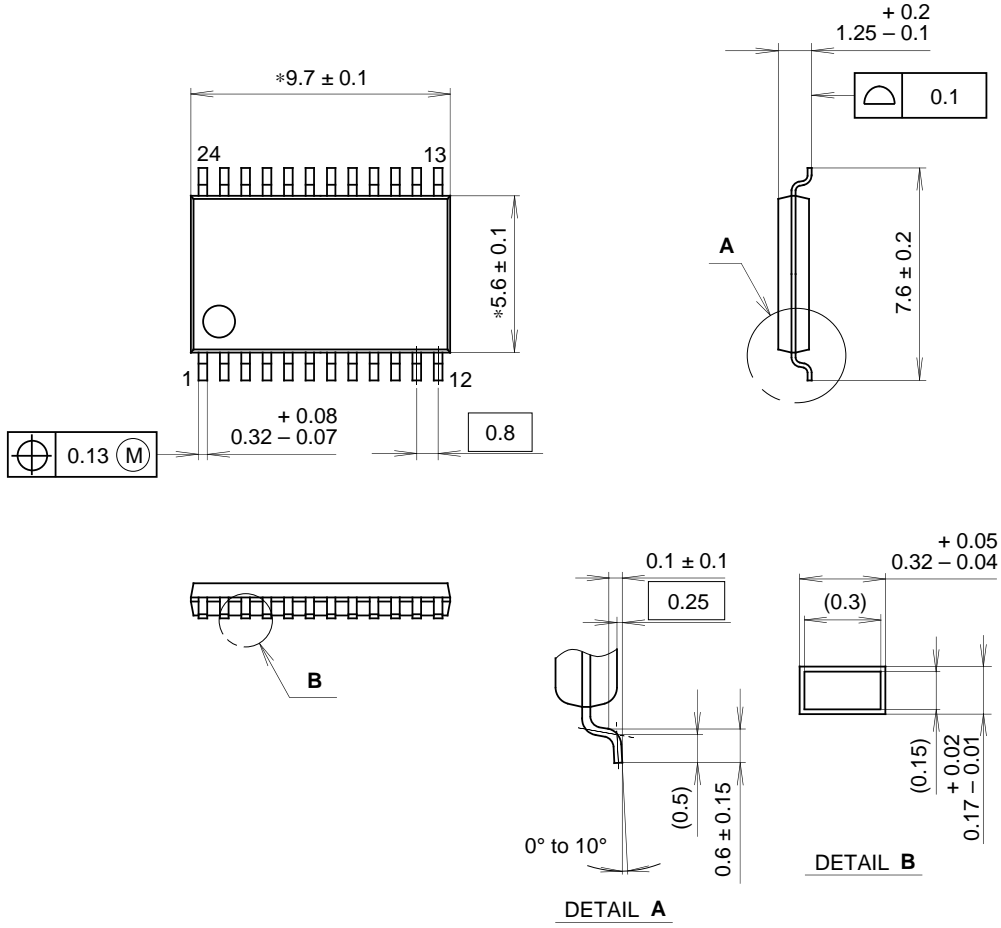

NOTE: Dimension "*" does not include mold protrusion.

PACKAGE STRUCTURE

SONY CODE	SSOP-24P-L03
EIAJ CODE	SSOP024-P-0056
JEDEC CODE	_____

PACKAGE MATERIAL	EPOXY RESIN
LEAD TREATMENT	SOLDER / PALLADIUM PLATING
LEAD MATERIAL	COPPER ALLOY
PACKAGE WEIGHT	0.1g