

The RF Line UHF Power Amplifier

... designed specifically for the Pan European digital 20 watt, GSM mobile radio. The MHW932 is capable of wide power range control, operates from a 12.5 volt supply and requires 100 mW of RF input power.

- Specified 12.5 Volt Characteristics:
 - RF Input Power — 100 mW (20 dBm)
 - RF Output Power — 32 W
 - Minimum Gain — 25 dB
 - Harmonics — -35 dBc Max @ 2.0 f_0
- New Biasing and Control Techniques Providing Dynamic Range and Control Circuit Bandwidth Ideal for GSM
- 50 Ohm Input/Output Impedances
- Guaranteed Stability and Ruggedness
- Test fixture circuit board photomaster available upon request by contacting RF Tactical Marketing in Phoenix, AZ.

MHW932

32 W
890 to 915 MHz
RF POWER
AMPLIFIER

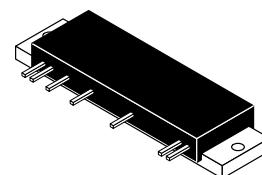

CASE 301S-02, STYLE 1

MAXIMUM RATINGS (Flange Temperature = 25°C)

Rating	Symbol	Value	Unit
DC Supply Voltage	V_S	15.6	Vdc
DC Bias Voltage	V_B	5.25	Vdc
RF Input Power	P_{in}	400	mW
RF Output Power	P_{out}	40	W
Operating Case Temperature Range	T_C	-30 to +100	°C
Storage Temperature Range	T_{stg}	-30 to +100	°C

ELECTRICAL CHARACTERISTICS

($V_{S1} = V_{S2} = V_{S3} = V_{S4} = 12.5$ Vdc; $V_B = 5.0$ Vdc, $T_C = +25^\circ\text{C}$, 50 ohm system, unless otherwise noted)

Characteristic	Symbol	Min	Max	Unit
Frequency Range	BW	890	915	MHz
Power Gain ($P_{out} = 32$ W) (1)	G_p	25	—	dB
Leakage Current ($P_{in} = 0$ mW, $V_B = 0$ Vdc, $V_{S1} = V_{S2} = V_{S3} = V_{S4} = 15.6$ Vdc)	I_L	—	10	mA
Efficiency ($P_{out} = 32$ W) (1)	η	23	—	%
Input VSWR ($P_{out} = 32$ W) (1)	VSWR _{in}	—	2.0:1	—
Harmonics ($P_{out} = 32$ W) (1)				
2.0 f_0		—	-35	dBc
3.0 f_0 to 5.0 f_0			-45	
Noise Power (In 30 kHz Bandwidth, 935 to 960 MHz frequency range; ($P_{out} = 0.03$ to 32 W; $V_{S1} = V_{S2} = V_{S3} = V_{S4} = 10.8$ to 15.6 Vdc) (1)		—	-65	dBm
Linearity — % AM in Output ($P_{out} = 0.02$ to 32 W; 135 kHz, 1% AM in Input)	—	—	6.0	%
Output Power, Low Voltage ($P_{IN} = 100$ mW; $V_{S1} = V_{S2} = V_{S3} = V_{S4} = 10.8$ Vdc)	P_{out2}	24	—	W
Load Mismatch Stress ($V_{S1} = V_{S2} = V_{S3} = V_{S4} = 15.6$ Vdc; $P_{out} = 40$ W; Load VSWR = 10:1, All Phase Angles at Frequency of Test) (1)	ψ	No Degradation In Output Power Before and After Test		
Stability ($V_{S1} = V_{S2} = V_{S3} = V_{S4} = 10.8$ to 15.6 Vdc; $P_{out} = 0.03$ to 32 W; Load VSWR = 6:1, Source VSWR = 3:1, All Phase Angles at Frequency of Test) (1)	—	All Spurious Outputs More Than 60 dB Below Desired Signal		

NOTE:

- Adjust P_{in} for Specified P_{out} ; Duty Cycle = 12.5%, Period = 4.6 msec

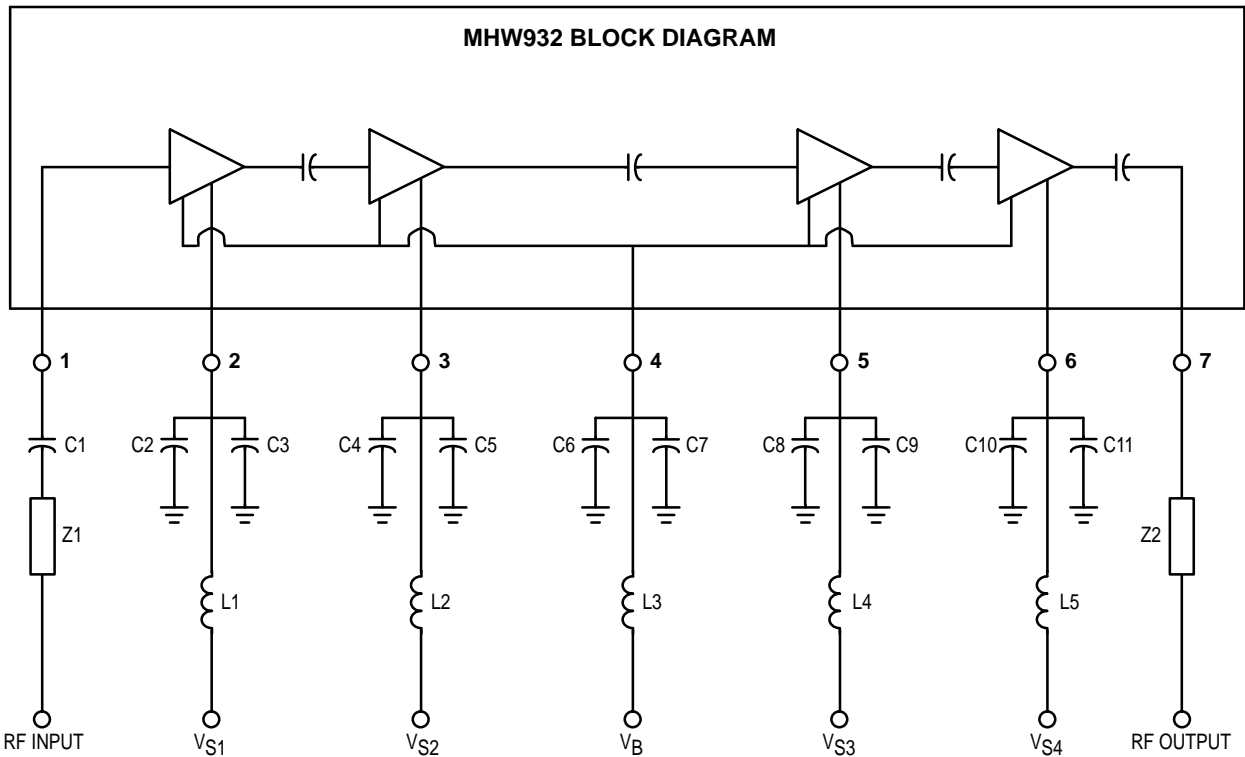

Pin Designations:

- Pin 1 — RF Input Power @ 20 dBm Max Adjust for Output Power
- Pin 2 — First Stage Collector Voltage @ 12.5 Vdc
- Pin 3 — Second Stage Collector Voltage @ 12.5 Vdc
- Pin 4 — Trickle Bias Voltage @ 5.0 Vdc
- Pin 5 — Third Stage Collector Supply @ 12.5 Vdc
- Pin 6 — Fourth Stage Collector Supply @ 12.5 Vdc
- Pin 7 — RF Output Power @ 32 W Nominal

Element Values:

- C1 = C2 = C4 = C6 = C8 = C10 = 0.018 μ F
- C3 = C5 = C7 = C9 = C11 = 2.2 μ F
- L1-L3 = 0.29 μ H
- L4 = 0.2 μ H
- L5 — VR200, Up to 10 A Max IS4
- Z1, Z2 = 50 Ohm Microstrip

Figure 1. Test Circuit Diagram

TYPICAL CHARACTERISTICS

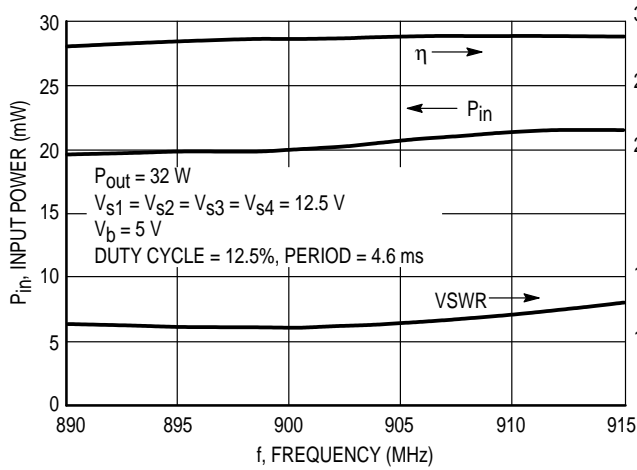

Figure 2. Input Power, Efficiency and Input VSWR versus Frequency

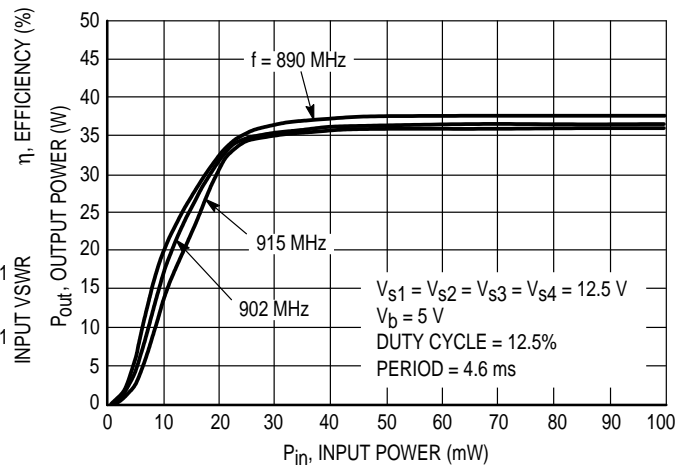

Figure 3. Output Power versus Input Power

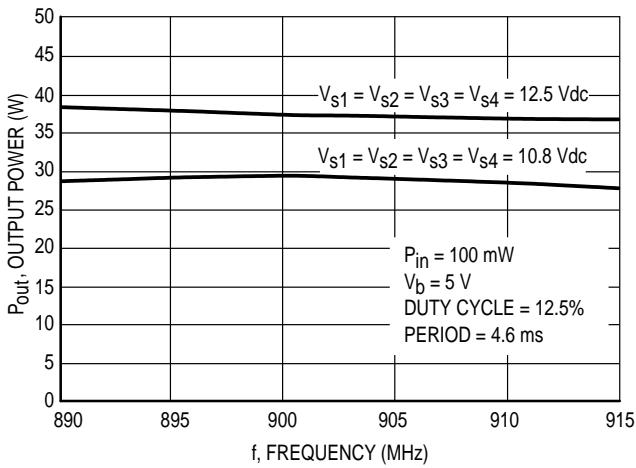

Figure 4. Output Power versus Frequency

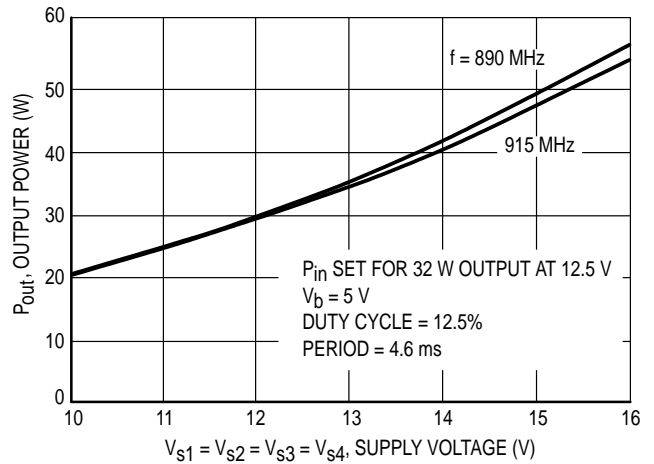

Figure 5. Output Power versus Supply Voltage

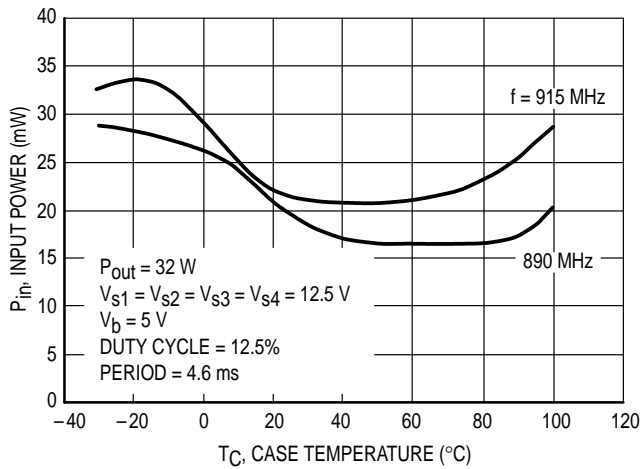

Figure 6. Input Power versus Case Temperature

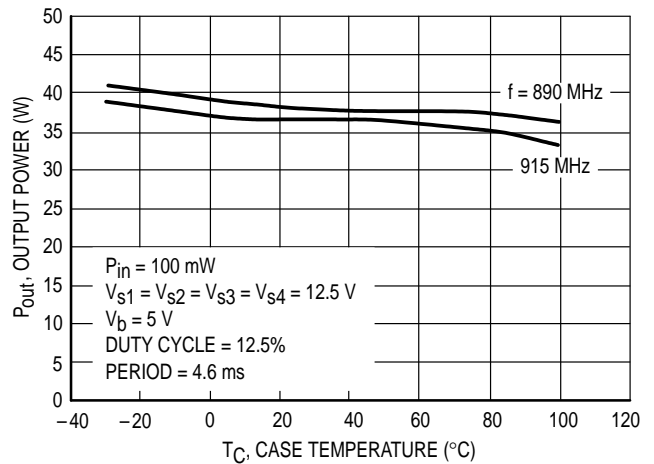

Figure 7. Output Power versus Case Temperature for Maximum Input Power

APPLICATIONS INFORMATION

NOMINAL OPERATION

All electrical specifications are based on the nominal conditions of $V_{S1} = V_{S2} = V_{S3} = V_{S4} = 12.5$ Vdc (Pins 2, 3, 5, 6), and $V_D = 5.0$ Vdc (Pin 4). With these conditions, maximum current density on any device is 1.5×10^5 A/cm² and maximum die temperature is 165°C. While the modules are designed to have excess gain margin with ruggedness, operation of these units outside the published specifications is not recommended unless prior communications regarding intended use have been made with the factory representative.

GAIN CONTROL

The module output power should be limited to specified value. The preferred method of power control is to fix $V_{S1} = V_{S2} = V_{S3} = V_{S4} = 12.5$ Vdc (Pins 2, 3, 5, 6), $V_D = 5.0$ Vdc (Pin 4), and vary P_{IN} (Pin 1) from 0 to 100 mW.

DECOUPLING

Due to the high gain of the four stages and the module size limitation, external decoupling networks require careful consideration, Pins 2, 3, 4, 5, and 6 are internally bypassed with a 0.018 μ F chip capacitor which is effective for frequencies from 5.0 MHz through 940 MHz. For bypassing frequencies below 5.0 MHz, networks equivalent to that shown in Figure 1 are recommended. Inadequate decoupling will result in spurious outputs at certain operating frequencies and certain phase angles of input and output VSWR.

LOAD MISMATCH

During final test each module is load mismatch tested in a fixture having the identical decoupling networks described in Figure 1. Electrical conditions are $V_{S1} = V_{S2} = V_{S3} = V_{S4} = 15.6$ Vdc (Pins 2, 3, 5, 6), and $V_D = 5.0$ Vdc (Pin 4), VSWR equal to 10:1, and output power equal to 40 watts.

PACKAGE DIMENSIONS

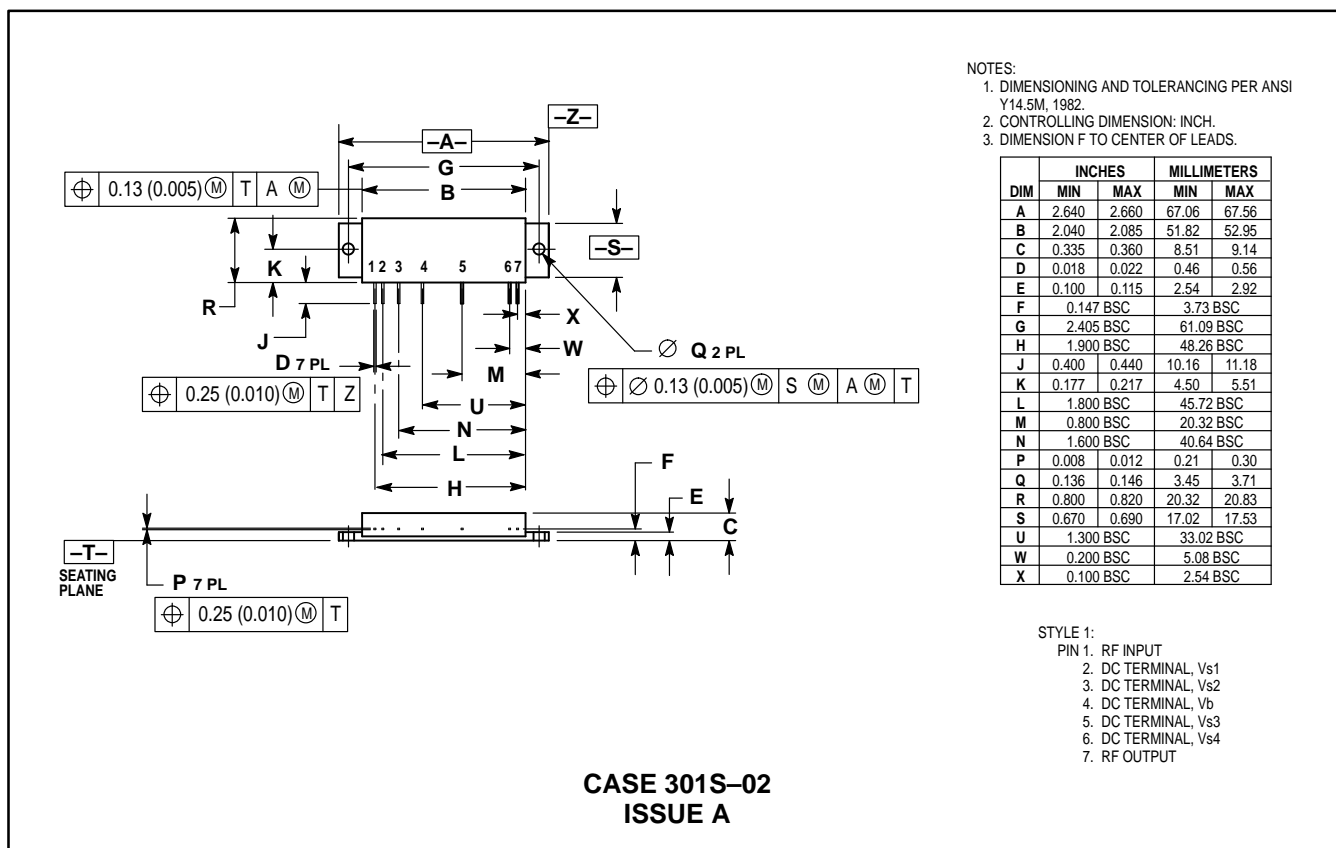

Motorola reserves the right to make changes without further notice to any products herein. Motorola makes no warranty, representation or guarantee regarding the suitability of its products for any particular purpose, nor does Motorola assume any liability arising out of the application or use of any product or circuit, and specifically disclaims any and all liability, including without limitation consequential or incidental damages. "Typical" parameters can and do vary in different applications. All operating parameters, including "Typicals" must be validated for each customer application by customer's technical experts. Motorola does not convey any license under its patent rights nor the rights of others. Motorola products are not designed, intended, or authorized for use as components in systems intended for surgical implant into the body, or other applications intended to support or sustain life, or for any other application in which the failure of the Motorola product could create a situation where personal injury or death may occur. Should Buyer purchase or use Motorola products for any such unintended or unauthorized application, Buyer shall indemnify and hold Motorola and its officers, employees, subsidiaries, affiliates, and distributors harmless against all claims, costs, damages, and expenses, and reasonable attorney fees arising out of, directly or indirectly, any claim of personal injury or death associated with such unintended or unauthorized use, even if such claim alleges that Motorola was negligent regarding the design or manufacture of the part. Motorola and are registered trademarks of Motorola, Inc. Motorola, Inc. is an Equal Opportunity/Affirmative Action Employer.

Literature Distribution Centers:

USA: Motorola Literature Distribution; P.O. Box 20912; Phoenix, Arizona 85036.

EUROPE: Motorola Ltd.; European Literature Centre; 88 Tanners Drive, Blakelands, Milton Keynes, MK14 5BP, England.

JAPAN: Nippon Motorola Ltd.; 4-32-1, Nishi-Gotanda, Shinagawa-ku, Tokyo 141, Japan.

ASIA PACIFIC: Motorola Semiconductors H.K. Ltd.; Silicon Harbour Center, No. 2 Dai King Street, Tai Po Industrial Estate, Tai Po, N.T., Hong Kong.



MHW932/D