

GaAs IC 35 dB Voltage Variable Attenuator Single Positive 3 V Control 0.5–2.5 GHz



AV106-12

Features

- Single Positive +3 V Control Voltage
- 35 dB Attenuation Range @ 0.9 GHz
- Excellent Linearity Performance

Description

The AV106-12 GaAs IC FET voltage variable attenuator provides 35 dB attenuation range at 900 MHz controlled by a single positive voltage. The VVA has a linear transfer curve of 12 dB/V slope, with input and output VSWR better than 2:1 over all states. Its attenuation range at 1900 MHz is 25 dB. It operates with supply voltage of +3 V and control voltage of 0 V to +3 V in a low cost SOIC-8 package. The RF ports require 25 pF DC blocking capacitors.

SOIC-8

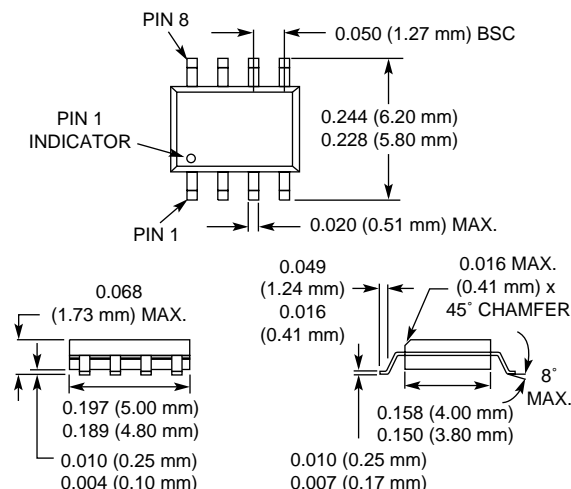

Electrical Specifications at 25°C (V_S = 3 V)

Parameter ¹	Frequency	Min.	Typ.	Max.	Unit
Insertion Loss (V _C = 0 V)	0.5–1.0 GHz		3.4	3.6	dB
	1.0–2.0 GHz		3.5	3.8	dB
	2.0–2.5 GHz		3.8	4.2	dB
Maximum Attenuation (V _C = 3 V) ²	0.5–0.8 GHz	25	32		dB
	0.8–1.0 GHz	34	37		dB
	1.0–1.7 GHz	28	33		dB
	1.7–2.0 GHz	25	30		dB
	2.0–2.5 GHz	23	26		dB
VSWR (I/O) ³	0.5–2.5 GHz		1.8:1		

Operating Characteristics at 25°C (V_S = 3 V)

Parameter ¹	Condition	Frequency	Min.	Typ.	Max.	Unit
Switching Characteristics	Rise, On (10/90% or 50% CTL to 90% RF)			1.0		μS
	Fall, Off (90/10% RF or 50% CTL to 10% RF)			0.3		μS
Intermodulation Intercept Point (IIP3) ³	For Two-tone Input Power +0 dBm	0.9 GHz		10		dBm
Control Voltage (V _C)			0.0		V _S	V
Supply Voltage (V _S)				3		V
Control Current (I _C)				0.2 x V _C		mA
Supply Current (I _S)				150		μA

1. All measurements made in a 50 Ω system, unless otherwise specified.
 2. Maximum attenuation includes insertion loss.
 3. For worst case state.

Typical Performance Data @ 0.9 GHz
(Unless Otherwise Specified)

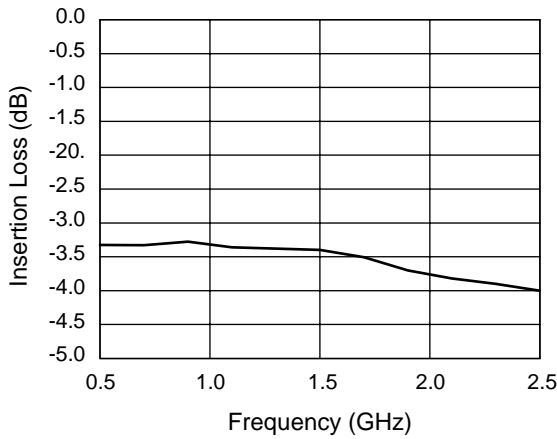

Insertion Loss vs. Frequency

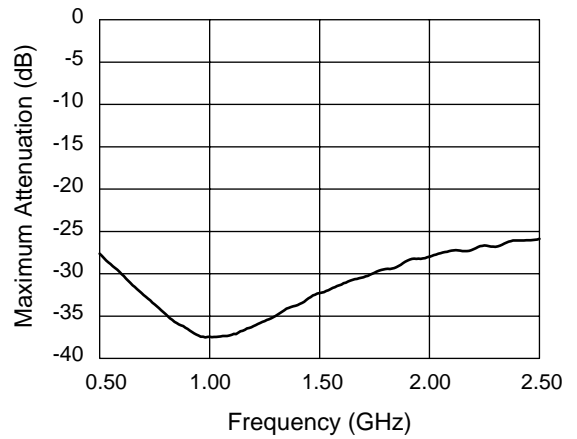

Maximum Attenuation vs. Frequency

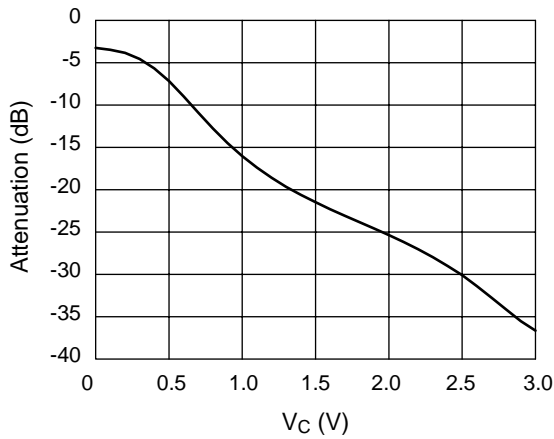

Attenuation vs. Control Voltage

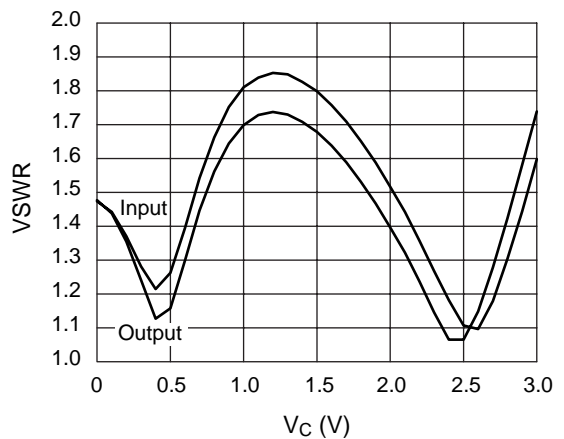

VSWR vs. Control Voltage

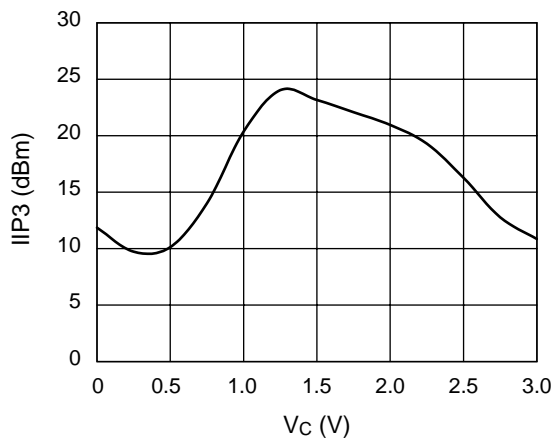

Input IP3 vs. Control Voltage

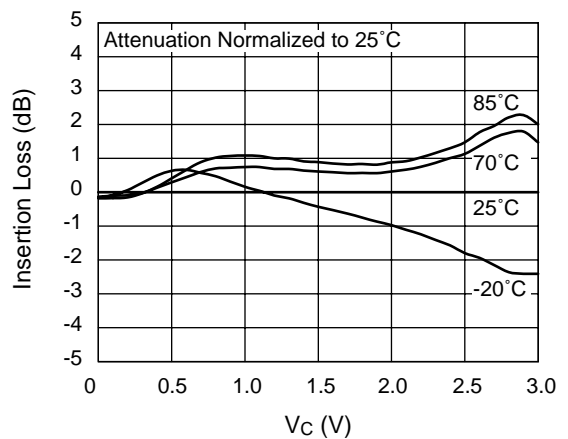

Attenuation vs. Control Voltage Over Temperature

Absolute Maximum Ratings

Characteristic	Value
RF Input Power	50 mW > 500 MHz
Supply Voltage	+7 V
Control Voltage	+3.3 V
Operating Temperature	-40°C to +85°C
Storage Temperature	-65°C to +150°C
Θ_{JC}	25°C/W

Note: Exceeding these parameters may cause irreversible damage.

Pin Out

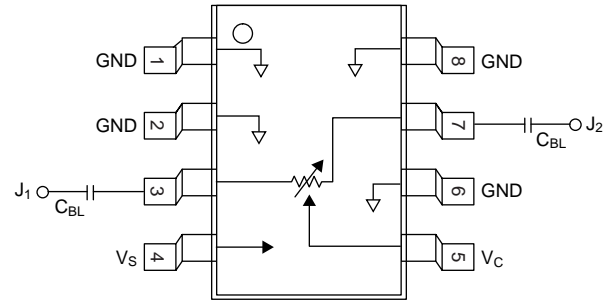

DC blocking capacitors (C_{BL}) supplied externally.
 $C_{BL} = 25 \text{ pF}$ for operation >500 MHz.