

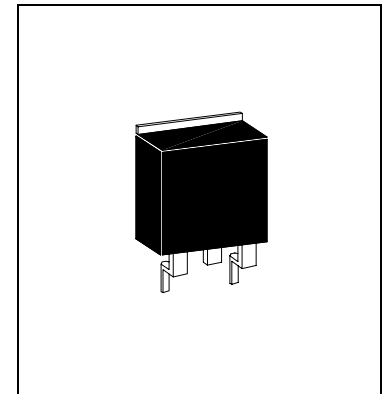

HU603AL

N-Channel Logic Level Enhancement Mode Field Effect Transistor



Description

This very high density process has been especially tailored to minimize on-state resistance and provide superior switching performance. These devices are particularly suited for low voltage applications such as DC/DC converters and other battery powered circuits where fast switching, low in-line power loss, and resistance to transients are needed.

Absolute Maximum Ratings (Ta=25°C)

- Maximum Temperatures
 Operating and Storage Temperature -65 ~ +175 °C
- Maximum Power Dissipation
 Total Power Dissipation at Tc=25°C 60 W
 Derate Above 25°C 0.4 W / °C
- Maximum Voltages and Currents
 Drain-Source Voltage 30 V
 Gate-Source Voltage -Continuous ±20 V
 Drain Current -Continuous 30 A
 Drain Current -Pulsed 100 A
 Thermal Resistance, Junction-to-Case 2.5 °C / W
 Thermal Resistance, Junction-to-Ambient 62.5 °C / W

Electrical Characteristics

• Off Characteristics

Symbol	Parameter	Condition	Min	Typ	Max	Unit
BV _{DSS}	Drain-Source Breakdown Voltage	V _{GS} =0V, I _D =250uA	30	-	-	V
I _{DSS}	Zero Gate Voltage Drain Current	V _{DS} =30V, V _{GS} =0V	-	-	10	uA
+I _{GSS}	Gate-Body Leakage ,Forward	V _{GS} =20V, V _{DS} =0V	-	-	100	nA
-I _{GSS}	Gate-Body Leakage ,Reverse	V _{GS} =-20V, V _{DS} =0V	-	-	-100	nA

• On Characteristics

V _{GS(TH)}	Gate Threshold Voltage	V _{DS} =V _{GS} , I _D =250uA	1.1	-	3	V
		V _{DS} =V _{GS} , I _D =10mA	1.4	-	3	
R _{DS(on)}	Static Drain-Source On-Resistance	V _{GS} =10V, I _D =25A	-	0.018	0.022	Ω
		V _{GS} =4.5V, I _D =10A	-	0.029	0.040	
I _{DS(on)}	On-State Drain Current	V _{GS} =10V, V _{DS} =10V	60	-	-	A
		V _{GS} =4.5V, V _{DS} =10V	15	-	-	
g _{FS}	Forward Transconductance	V _{DS} =10V, I _D =25A	-	26	-	S

• Dynamic Characteristic

C _{iSS}	Input Capacitance	V _{DS} =15V, V _{GS} =0V f=1.0Mhz	-	1100	-	pF
C _{oSS}	Output Capacitance		-	600	-	pF
C _{rSS}	Reverse Transfer Capacitance		-	180	-	pF



• Switching Characteristics

Symbol	Parameter	Condition	Min	Typ	Max	Unit
T(on)	Turn-On Delay Time	$V_{DS}=15V, I_D=25A$ $V_{GS}=10V, R_{GEN}=24\Omega$	-	-	30	ns
	Turn-On Rise Time		-	-	110	ns
T(off)	Turn-Off Delay Time		-	-	150	ns
	Turn-Off Fall Time		-	-	130	ns
Q_g	Total Gate Charge	$V_{DS}=10V, I_D=25A,$ $V_{GS}=10V$	-	-	45	nC
Q_{gs}	Gate-Source Charge		-	-	10	nC
Q_{gd}	Gate-Drain Charge		-	-	10	nC

• Drain-Source Diode Characteristics And Maximum Ratings

V_{SD}	Maximum Continuous Drain-Source Diode Forward Current	-	-	25	A
	Drain-Source Diode Forward Voltage	$V_{GS}=0V, I_S=25A$	-	-	1.3

Characteristics Curve

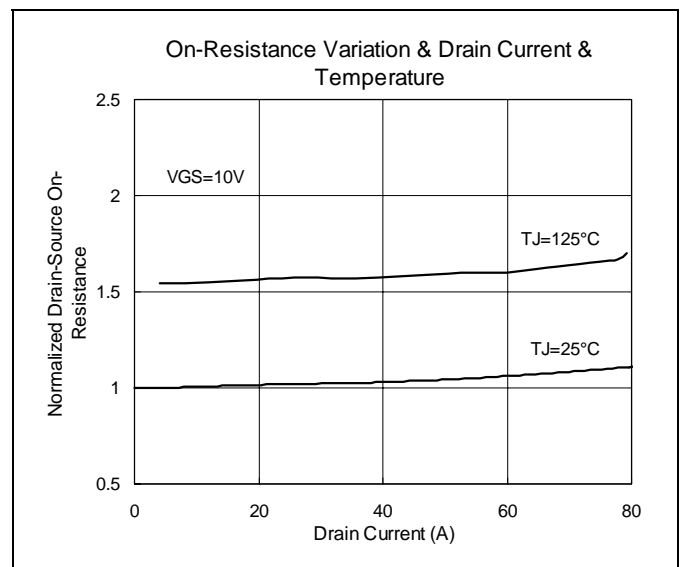
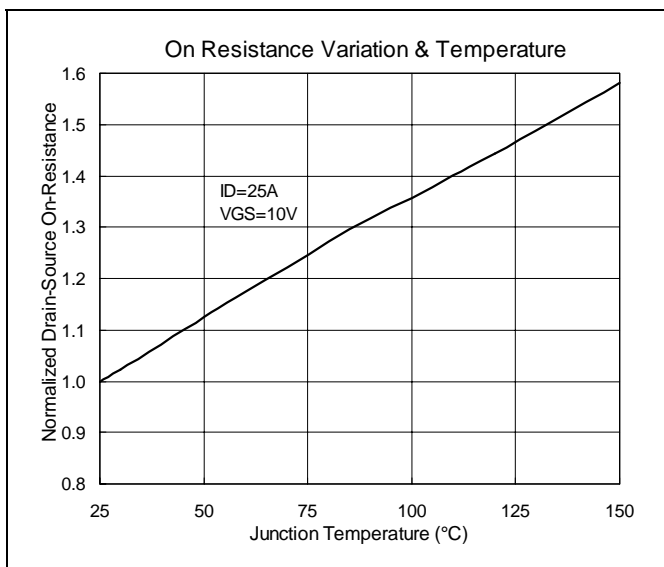
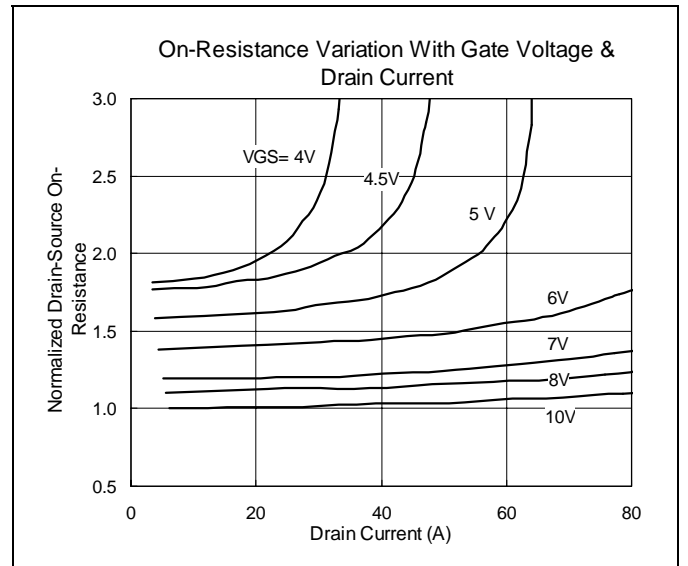
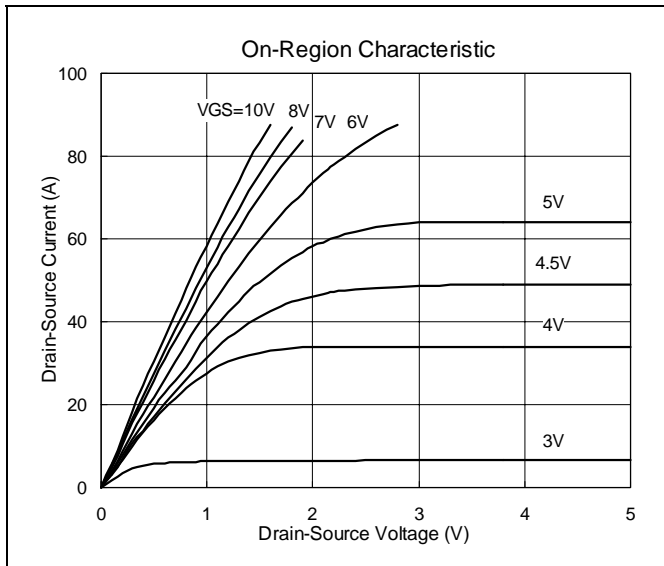

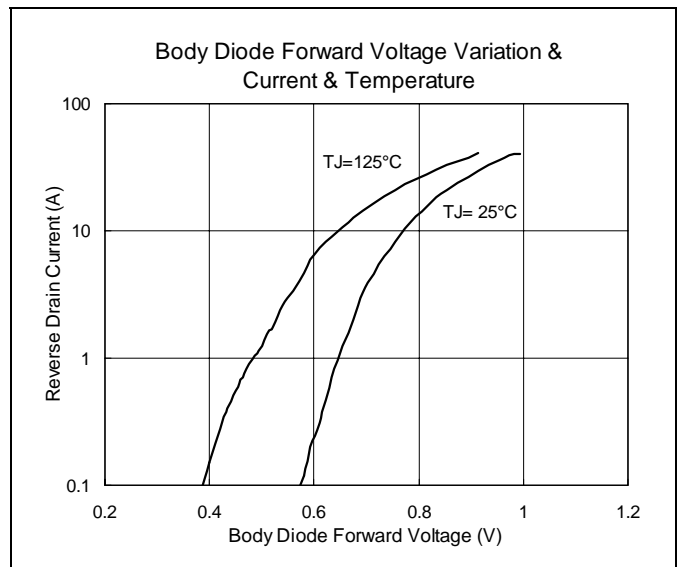
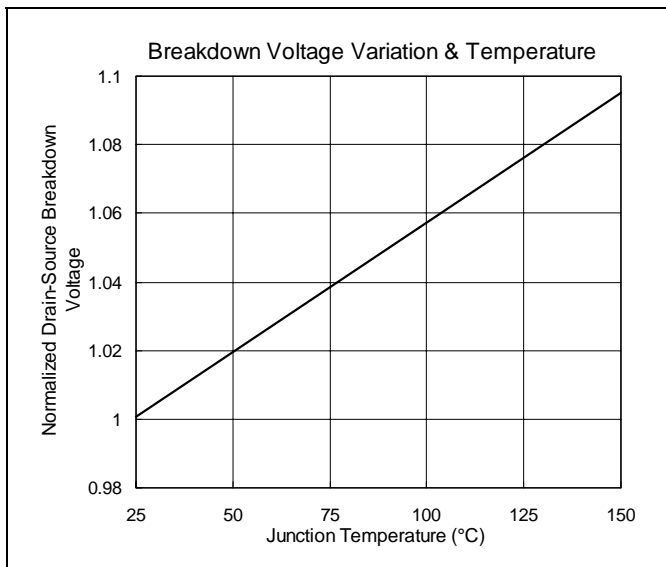
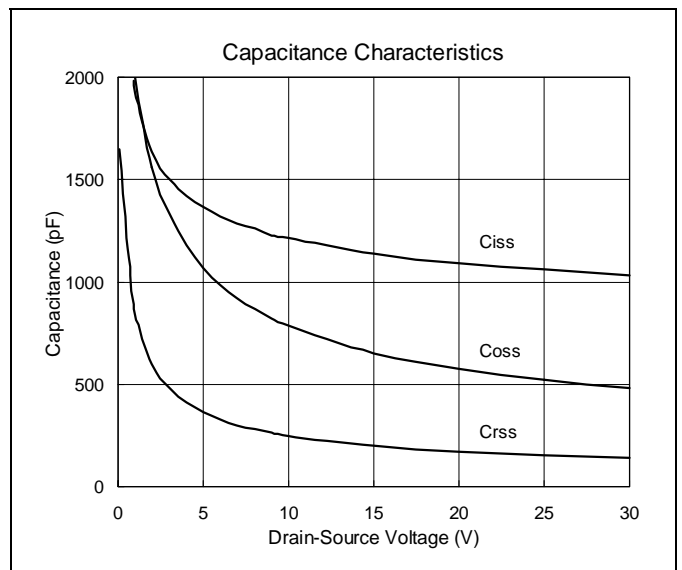
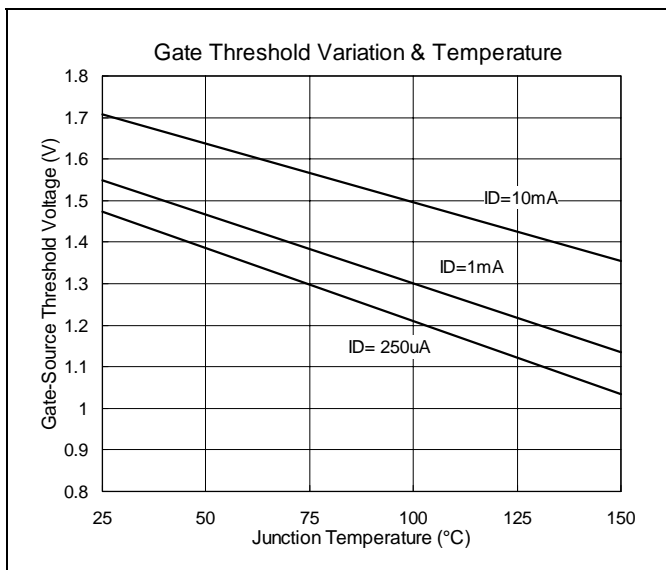
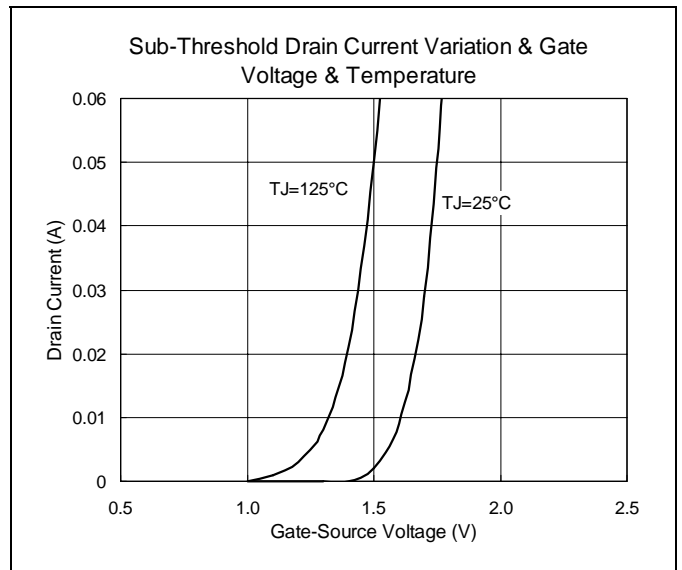
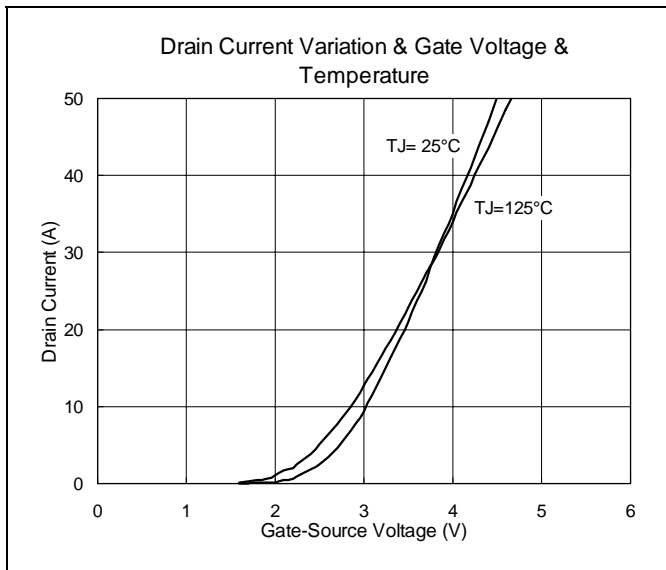

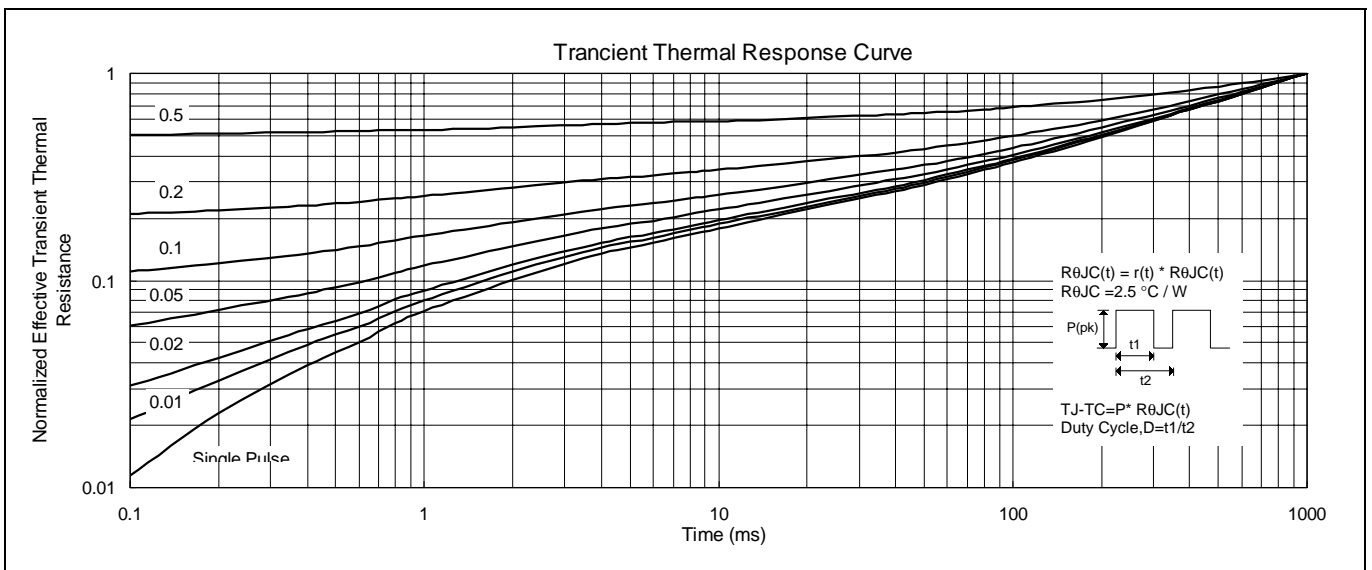
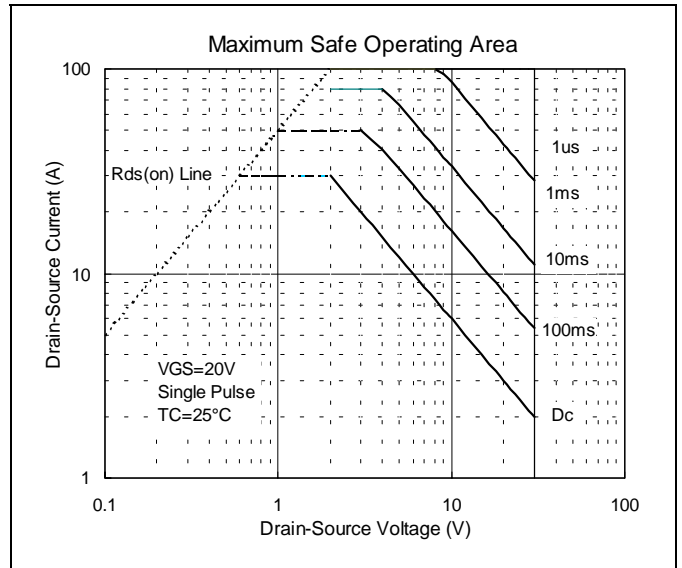
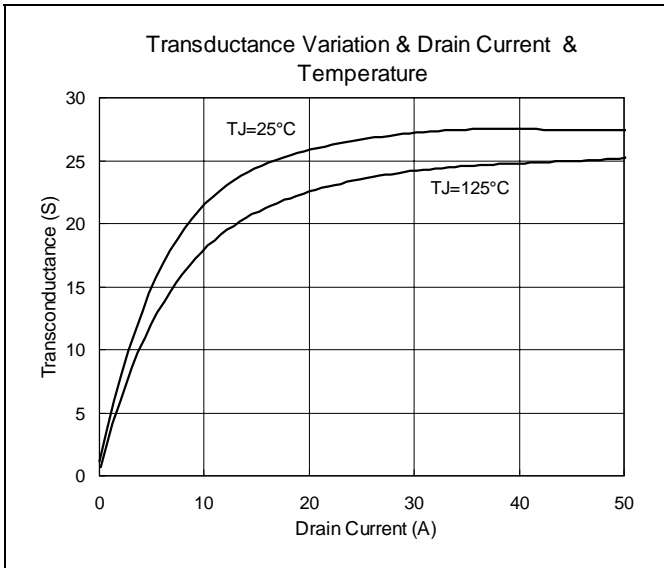



TO-263 Dimension

Marking :

HSMC Logo		Product Series
Part Number		Rank
Date Code		

Style : Pin 1.Gate 2.Drain 3.Source

3-Lead TO-263 Plastic Surface Mounted Package
HSMC Package Code : U

*:Typical

DIM	Inches		Millimeters		DIM	Inches		Millimeters	
	Min.	Max.	Min.	Max.		Min.	Max.	Min.	Max.
A	0.3800	0.4050	9.65	10.29	I	0.0500	0.0700	1.27	1.78
B	0.3300	0.3700	8.38	9.40	J	-	*0.1000	-	*2.54
C	-	0.0550	-	1.40	K	0.0450	0.0550	1.14	1.40
D	0.5750	0.6250	14.61	15.88	L	0.0200	0.0390	0.51	0.99
E	0.1600	0.1900	4.06	4.83	$\alpha 1$	-	-	6°	8°
F	0.0450	0.0550	1.14	1.40	$\alpha 2$	-	-	6°	8°
G	0.0900	0.1100	2.29	2.79	$\alpha 3$	-	-	0°	5°
H	0.0180	0.0290	0.46	0.74					

Notes : 1.Dimension and tolerance based on our Spec. dated Jan. 09,1998.
 2.Controlling dimension : millimeters.
 3.Maximum lead thickness includes lead finish thickness, and minimum lead thickness is the minimum thickness of base material.
 4.If there is any question with packing specification or packing method, please contact your local HSMC sales office.

Material :

- Lead : 42 Alloy ; solder plating
- Mold Compound : Epoxy resin family, flammability solid burning class:UL94V-0

Important Notice:

- All rights are reserved. Reproduction in whole or in part is prohibited without the prior written approval of HSMC.
- HSMC reserves the right to make changes to its products without notice.
- **HSMC semiconductor products are not warranted to be suitable for use in Life-Support Applications, or systems.**
- HSMC assumes no liability for any consequence of customer product design, infringement of patents, or application assistance.

Head Office And Factory :

- **Head Office** (Hi-Sincerity Microelectronics Corp.) : 10F.,No. 61, Sec. 2, Chung-Shan N. Rd. Taipei Taiwan R.O.C.
 Tel : 886-2-25212056 Fax : 886-2-25632712, 25368454
- **Factory 1** : No. 38, Kuang Fu S. Rd., Fu-Kou Hsin-Chu Industrial Park Hsin-Chu Taiwan. R.O.C
 Tel : 886-3-5983621~5 Fax : 886-3-5982931
- **Factory 2** : No. 17-1, Ta-Tung Rd., Fu-Kou Hsin-Chu Industrial Park Hsin-Chu Taiwan. R.O.C
 Tel : 886-3-5977061 Fax : 886-3-5979220