

L-BAND SPDT SWITCH

DESCRIPTION

The μ PG137GV is a L-Band SPDT (Single Pole Double Throw) GaAs FET switch which was developed for digital mobile communication system.

It housed in an very small 8-pin SSOP that is smaller than usual 8-pin SOP and easy to install and contributes to miniaturizing the system.

FEATURES

- Maximum transmission power : +35 dBm min. (@ $V_{CONT} = +5$ V/0 V)
+34 dBm typ. (@ $V_{CONT} = +3$ V/0 V)
- Low insertion loss : 0.55 dB typ. (@ 1 GHz)
0.65 dB typ. (@ 2 GHz)

APPLICATION

- Digital Cellular : GSM, PDC, PCN etc.
- PHS Base Station, PCS etc.

ORDERING INFORMATION

PART NUMBER	PACKAGE	PACKING FORM
μ PG137GV-E1	8 pin plastic SSOP (175 mil)	Carrier tape width 12 mm Qty 2 kp/Reel.

ABSOLUTE MAXIMUM RATINGS ($T_A = 25$ °C)

PARAMETERS	SYMBOL	RATINGS	UNIT
Control Voltage 1, 2	$V_{CONT1,2}$	-0.6 to +6.0 ^{Note}	V
Input Power ($V_{CONT} = +5$ V)	P_{in}	+36	dBm
Input Power ($V_{CONT} = +3$ V)	P_{in}	+34	dBm
Total Power Dissipation	P_{tot}	0.7	W
Operating Temperature	T_{opt}	-50 to +80	°C
Storage Temperature	T_{stg}	-65 to +150	°C

Note () stands for the case of positive control condition using the floating.
Condition $2.7 \leq |V_{CONT1} - V_{CONT2}| \leq 6.0$ V

Caution The IC must be handled with care to prevent static discharge because its circuit composed of GaAs MES FET.

PIN CONNECTION DIAGRAM (Top View)

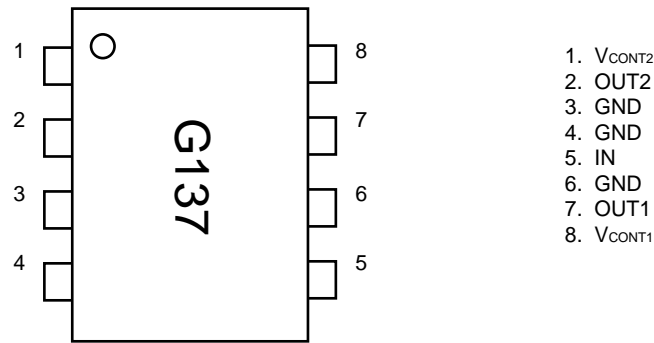

SPDT SWITCH IC SERIES PRODUCTS

PART NUMBER	PIN (1 dB) (dBm)	L _{INS} (dB)	ISL (dB)	V _{CONT} (V)	PACKAGE	APPLICATIONS
μPG130G	+34	0.5 @ 1 G	32 @ 1 G	-5/0	8-pin SSOP (175 mil)	PDC, IS-136, PHS
μPG131G	+30	0.6 @ 2 G	23 @ 2 G	-4/0		PHS, PCS, WLAN
μPG132G	+30	0.6 @ 2 G	22 @ 2 G	+3/0		PHS, PCS, WLAN
μPG133G	+25	0.6 @ 2 G	20 @ 2 G	-3/0		DIVERSITY, VCO
μPG137GV	+34	0.55 @ 1 G	25 @ 2 G	+3/0		PDC, GSM, IS-136
μPG138GV	+34 +37	0.55 @ 1 G	30 @ 1 G	-3/0 -5/0		PDC, GSM, IS-136

Remark As for detail information of series products, please refer to each data sheet.

[μPG137GV]

RECOMMENDED OPERATING CONDITIONS

PARAMETER	SYMBOL	MIN.	TYP.	MAX.	UNIT
Control Voltage (ON)	V _{CONT}	+2.7	+3.0	+5.3	V
Control Voltage (OFF)	V _{CONT}	-0.2	0	+0.2	V
Input Power (V _{CONT} = +5 V)	P _{in}			+35	dBm
Input Power (V _{CONT} = +3 V)	P _{in}			+33	dBm

ELECTRICAL CHARACTERISTICS

(UNLESS OTHERWISE SPECIFIED T_A = 25 °C, V_{CONT} = +3 V/0 V)

CHARACTERISTICS	SYMBOL	TEST CONDITION	MIN.	TYP.	MAX.	UNIT
Insertion Loss 1	L _{INS1}	f = 100 M to 1 GHz		0.55	0.75	dB
Insertion Loss 2	L _{INS2}	f = 2.0 GHz		0.65	0.90	dB
Insertion Loss 3	L _{INS3}	f = 2.5 GHz		0.8 ^{Note 1}		dB
Isolation 1	I _{SL1}	f = 100 M to 2 GHz	20	25		dB
Input Return Loss	RL _{in}	f = 100 M to 2 GHz	11			dB
Output Return Loss	RL _{out}		11			dB
Input Power at 1 dB Compression Point	P _{in} (1 dB) ^{Note 2}	f = 500 M to 2 GHz	+32	+34		dBm
Input Power at 0.5 dB Compression Point	P _{in} (0.5 dB)	f = 500 M to 2 GHz V _{CONT} = +5 V/0 V	+34			dBm
Switching Speed	t _{sw}			30		ns
Control Current	I _{CONT}	V _{CONT} = +5 V/0 V			5	μA

Notes 1. Characteristic for reference at 2.0 to 2.5 GHz.

2. P_{in} (1 dB) is measured the input power level when the insertion loss increase more 1 dB than that of linear range.

All other characteristics are measured in linear range.

NOTE ON CORRECT USE

- When the μPG137GV is used it is necessary to use DC blocking capacitor for No. 2 pin (OUT2), No. 5 pin (IN) and No. 7 pin (OUT1). The value of DC blocking capacitors should be chosen to accommodata the frequency of operation.
- Insertion loss and isolation of the IN-OUT2 is better than that of IN-OUT1, because No. 7 pin (OUT1) is placed to same side of No. 5 pin (IN).
- The distance between IC's GND pins and ground pattarn of substrate should be as shorter as possible to avoid parasitic parameters.

TYPICAL CHARACTERISTICS (T_A = 25 °C) (This data is including loss of the test fixture)

IN-OUT1 INSERTION LOSS vs. FREQUENCY

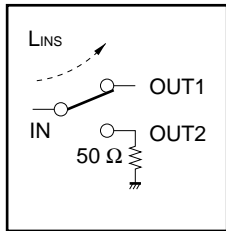
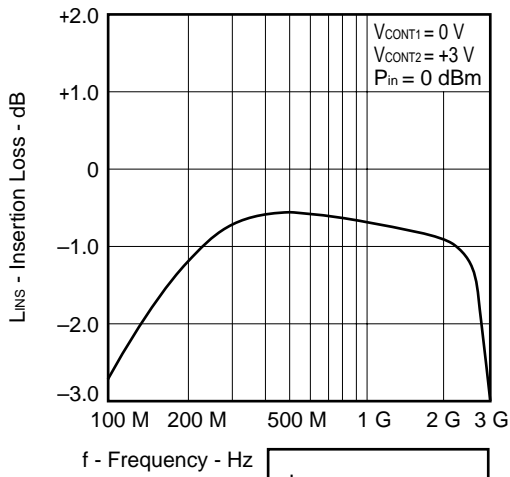

IN-OUT1 ISOLATION vs. FREQUENCY

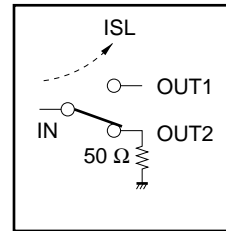
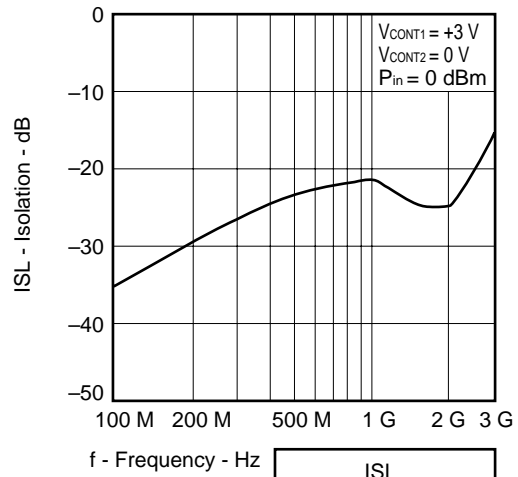

IN-OUT1 INPUT RETURN LOSS vs. FREQUENCY

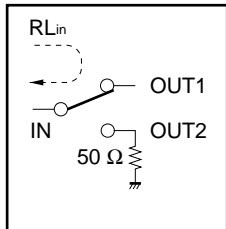
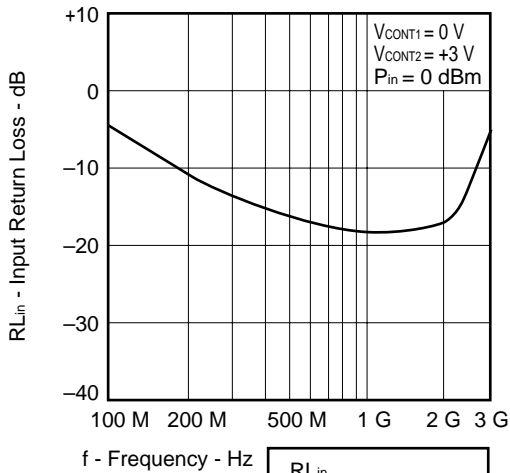

IN-OUT1 OUTPUT RETURN LOSS vs. FREQUENCY

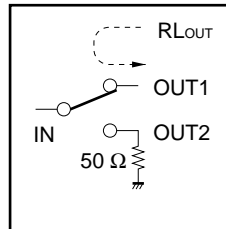
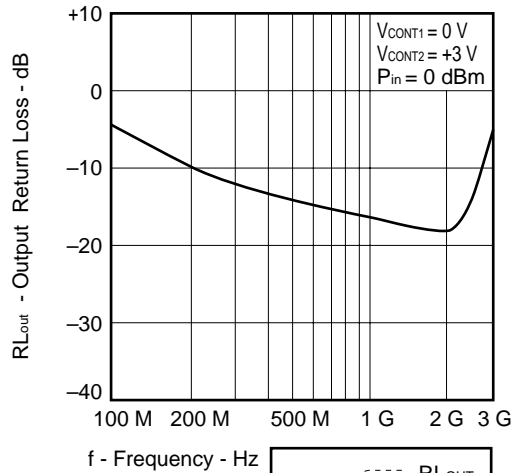

IN-OUT2 INSERTION LOSS vs. FREQUENCY

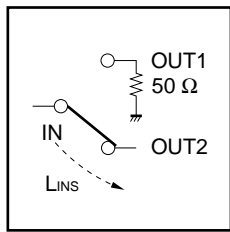
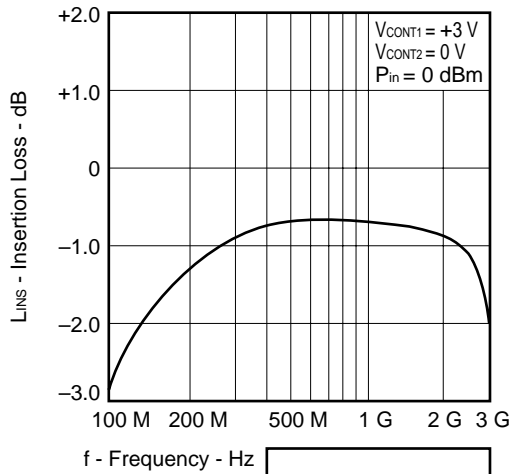

IN-OUT2 ISOLATION vs. FREQUENCY

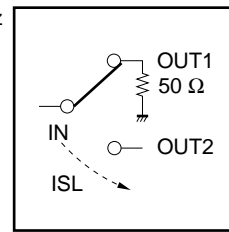
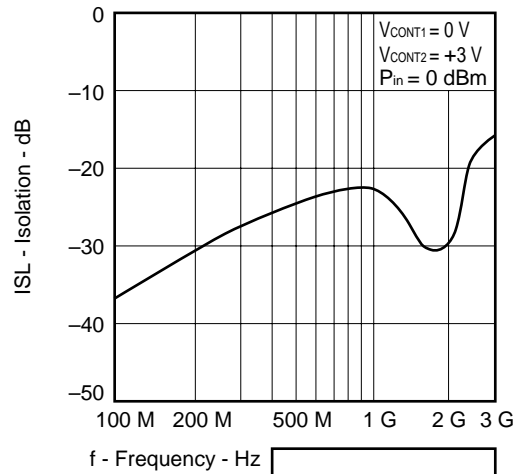

IN-OUT2 INPUT RETURN LOSS vs. FREQUENCY

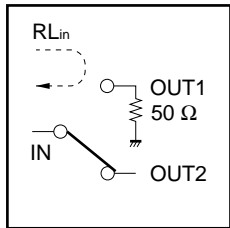
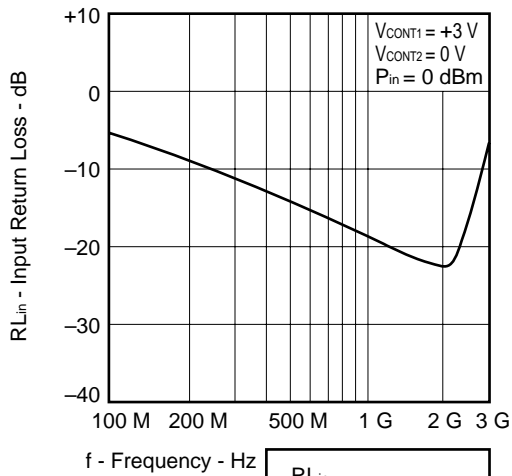

IN-OUT2 OUTPUT RETURN LOSS vs. FREQUENCY

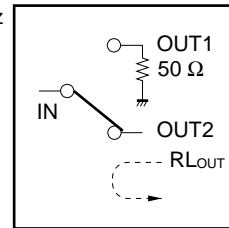
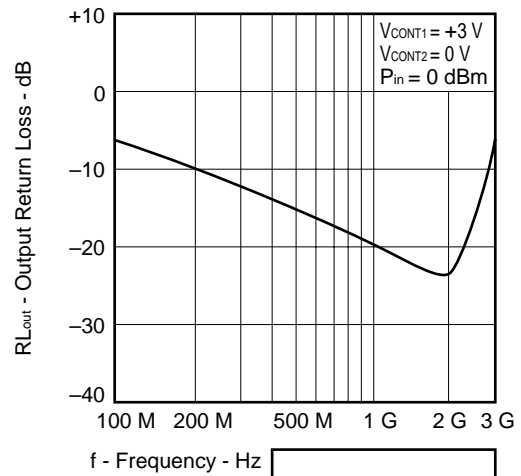

TEMPERATURE CHARACTERISTICS

Pin (1dB) vs. AMBIENT TEMPERATURE

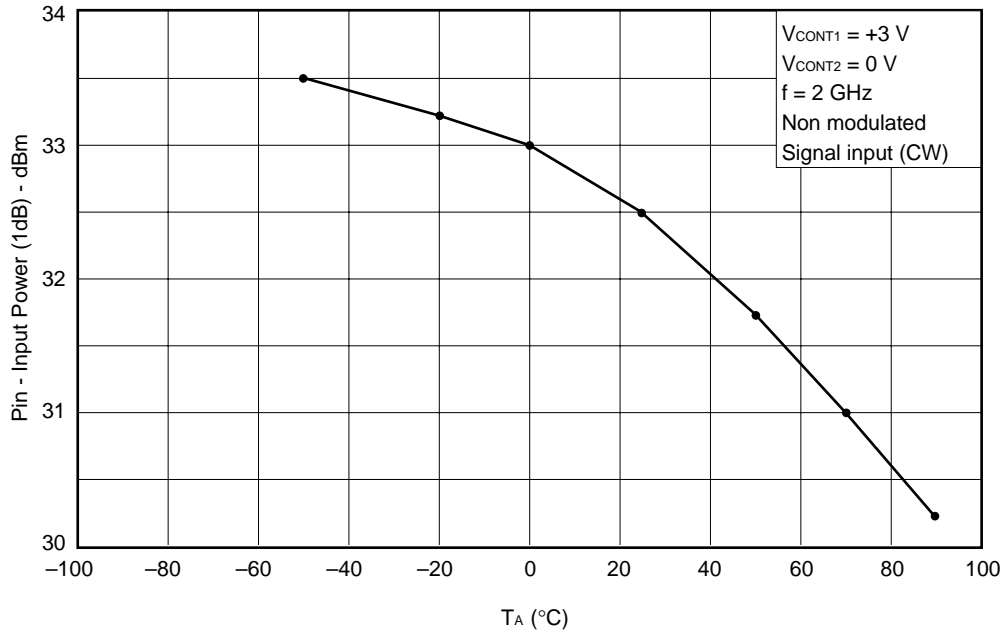

INSERTION LOSS, 2fo, 3fo vs. AMBIENT TEMPERATURE

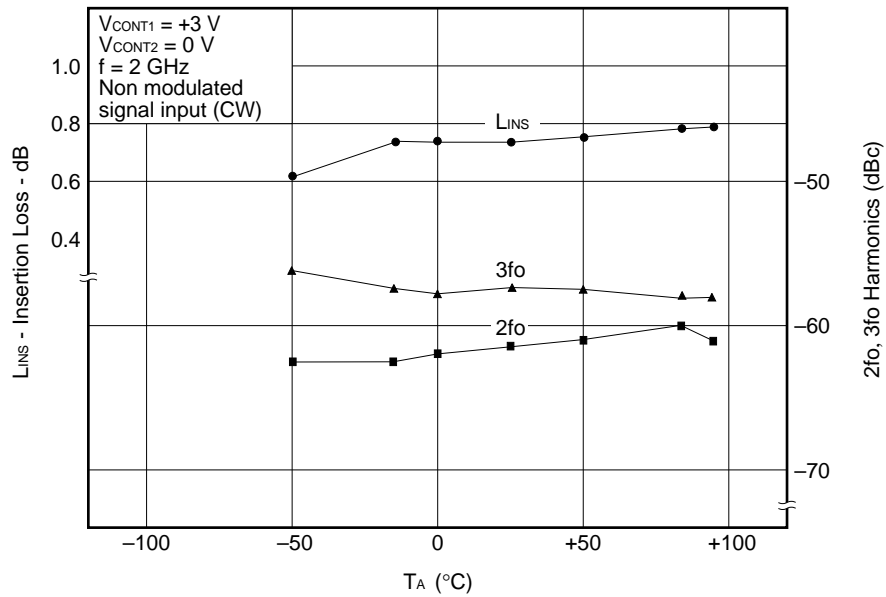

[μ PG137GV]

TEST BOARD

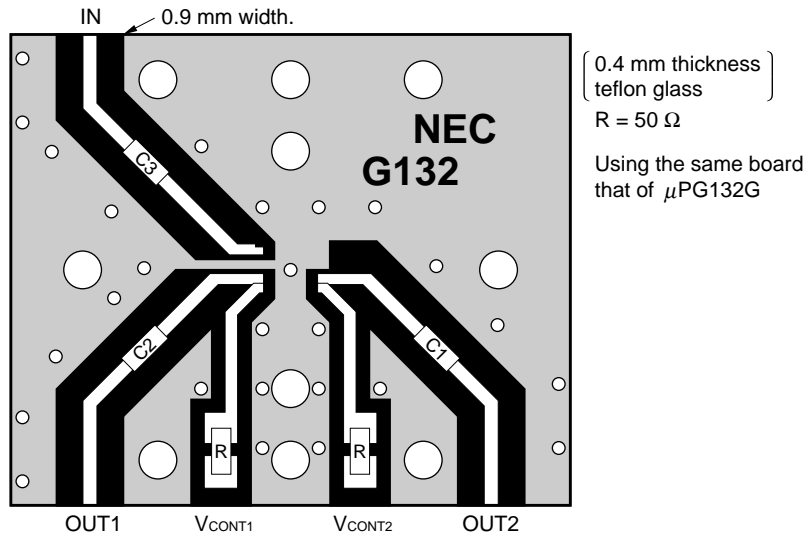

TEST CIRCUIT

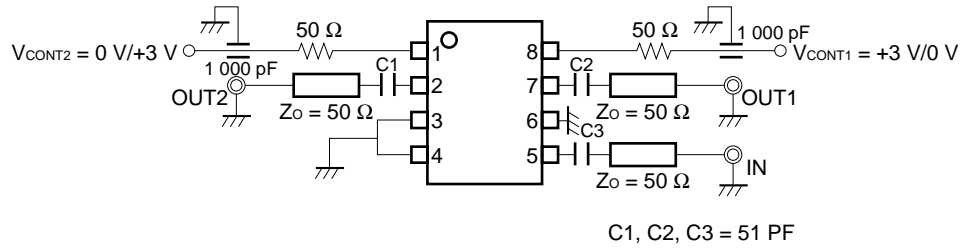

[μPG137GV]

TRUTH TABLE OF SWITCHING BY CONDITION OF CONTROL VOLTAGE

		V _{CONT1}	
		+3 V	0 V
V _{CONT2}	+3 V		
	0 V		

PACKAGE DIMENSIONS

8-PIN PLASTIC SHRINK SOP (175 mil) (Unit mm)

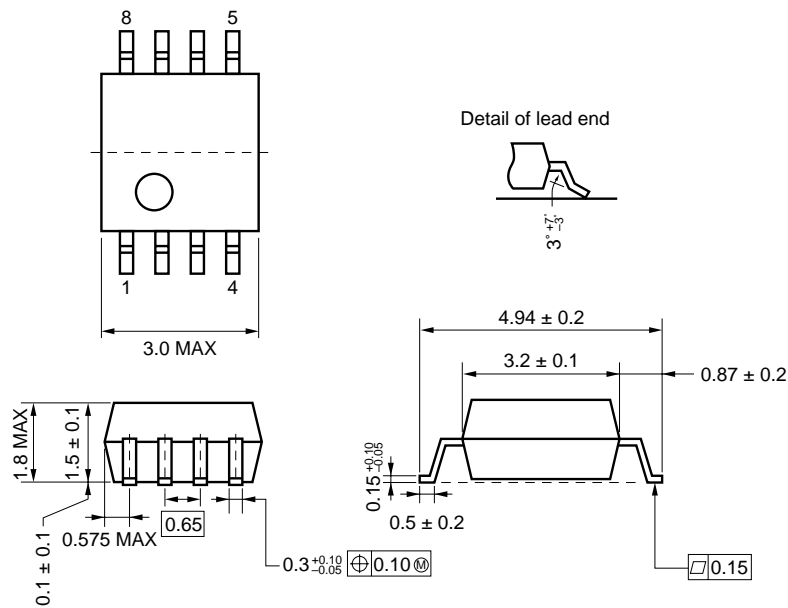

RECOMMENDED SOLDERING CONDITIONS

This product should be soldered in the following recommended conditions. Other soldering methods and conditions than the recommended conditions are to be consulted with our sales representatives.

[μPG137GV]

Soldering process	Soldering conditions	Recommended condition symbol
Infrared ray reflow	Package peak temperature: 235 °C Hour: within 30 s. (more than 210 °C) Time: 3 times, Limited days: no. ^{Note}	IR35-00-3
VPS	Package peak temperature: 215 °C Hour: within 40 s. (more than 200 °C) Time: 3 times, Limited days: no. ^{Note}	VP15-00-3
Wave soldering	Soldering tub temperature: less than 260 °C, Hour: within 10 s. Time: 1 time, Limited days: no. ^{Note}	WS60-00-1
Pin part heating	Pin area temperature: less than 300 °C, Hour: within 10 s. Limited days: no. ^{Note}	

Note It is storage days after opening a dry pack, the storage conditions are 25 °C, less than 65 %, RH.

Caution The combined use of soldering method is to be avoided (However, except the pin area heating method).

[MEMO]

[MEMO]

Caution

**The Great Care must be taken in dealing with the devices in this guide.
The reason is that the material of the devices is GaAs (Gallium Arsenide), which is designated as harmful substance according to the law concerned.
Keep the law concerned and so on, especially in case of removal.**

No part of this document may be copied or reproduced in any form or by any means without the prior written consent of NEC Corporation. NEC Corporation assumes no responsibility for any errors which may appear in this document.

NEC Corporation does not assume any liability for infringement of patents, copyrights or other intellectual property rights of third parties by or arising from use of a device described herein or any other liability arising from use of such device. No license, either express, implied or otherwise, is granted under any patents, copyrights or other intellectual property rights of NEC Corporation or others.

While NEC Corporation has been making continuous effort to enhance the reliability of its semiconductor devices, the possibility of defects cannot be eliminated entirely. To minimize risks of damage or injury to persons or property arising from a defect in an NEC semiconductor device, customers must incorporate sufficient safety measures in its design, such as redundancy, fire-containment, and anti-failure features.

NEC devices are classified into the following three quality grades:

"Standard", "Special", and "Specific". The Specific quality grade applies only to devices developed based on a customer designated "quality assurance program" for a specific application. The recommended applications of a device depend on its quality grade, as indicated below. Customers must check the quality grade of each device before using it in a particular application.

- Standard: Computers, office equipment, communications equipment, test and measurement equipment, audio and visual equipment, home electronic appliances, machine tools, personal electronic equipment and industrial robots
- Special: Transportation equipment (automobiles, trains, ships, etc.), traffic control systems, anti-disaster systems, anti-crime systems, safety equipment and medical equipment (not specifically designed for life support)
- Specific: Aircrafts, aerospace equipment, submersible repeaters, nuclear reactor control systems, life support systems or medical equipment for life support, etc.

The quality grade of NEC devices is "Standard" unless otherwise specified in NEC's Data Sheets or Data Books. If customers intend to use NEC devices for applications other than those specified for Standard quality grade, they should contact an NEC sales representative in advance.

Anti-radioactive design is not implemented in this product.