

L-BAND UP/DOWN CONVERTER

DESCRIPTION

The μ PG2121TB is L-band up-converter or down-converter IC (LO Buff. Amp. + Passive Mixer). The device can convert the RF frequency to IF frequency and operate low current. It housed in an original 6-pin super minimold package that is smaller than usual 6-pin minimold easy to install and contributes to miniaturizing the system.

FEATURES

- +2.8 V single voltage
- Low distortion (IIP₃ = +23 dBm TYP.)
- Low current operation (I_{DD} = 3.5 mA TYP.)
- LO buffer amplifier and passive mixer on a single chip
- 6-pin super minimold package (Size: 2.0 × 1.25 × 0.9 mm)

APPLICATION

- L-band digital cellular etc.

ORDERING INFORMATION

Part Number	Package	Marking	Supplying Form
μ PG2121TB-E3	6-pin super minimold	G2E	Embossed tape 8 mm wide. Pin 1 face the tape perforation side. Qty 3kpcs / reel.

Remark To order evaluation samples, please contact your local NEC sales office.
(Part number for sample order: μ PG2121TB)

Caution The IC must be handled with care to prevent static discharge because its circuit composed of GaAs HJ-FET.

The information in this document is subject to change without notice. Before using this document, please confirm that this is the latest version.
Not all devices/types available in every country. Please check with local NEC representative for availability and additional information.

PIN CONNECTIONS

Pin No.	Connection	Pin No.	Connection
1	RF or IF	4	LO IN
2	GND	5	GND
3	V _{DD}	6	IF or RF

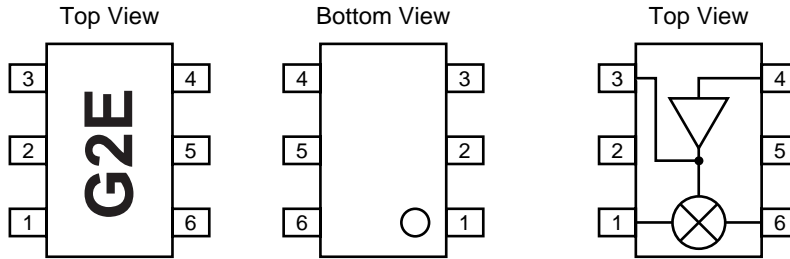

ABSOLUTE MAXIMUM RATINGS (T_A = +25 °C)

Parameter	Symbol	Ratings	Unit
Supply Voltage	V _{DD}	6.0	V
LO Input Power	P _{LO}	+10	dBm
RF Input Power	P _{RF}	+10	dBm
Total Power Dissipation	P _{tot}	140 ^{Note}	mW
Operating Ambient Temperature	T _A	-30 to +90	°C
Storage Temperature	T _{stg}	-35 to +150	°C

Note Mounted on a 50 × 50 × 1.6 mm double copper clad epoxy glass PWB, T_A = +85 °C

ELECTRICAL CHARACTERISTICS (T_A = +25 °C)

Parameter	Symbol	MIN.	TYP.	MAX.	Unit
Supply Voltage	V _{DD}	+2.7	+2.8	+3.0	V
RF Frequency	f _{RF}	810	–	960	MHz
IF Frequency	f _{IF}	50	–	400	MHz
LO Input Power	P _{LO}	–10	–5	0	dBm

ELECTRICAL CHARACTERISTICS

(Unless otherwise specified, T_A = +25 °C, V_{DD} = 2.8 V, f_{RF1} = 850 MHz, f_{RF2} = 850.1 MHz, P_{RF1} = P_{RF2} = –3 dBm, f_{LO} = 940 MHz, P_{LO} = –5 dBm, f_{IF} = 90 MHz, f_{IM3} = 90.1 MHz)

Parameter	Symbol	Test Condition	MIN.	TYP.	MAX.	Unit
Total Current	I _{DD}		–	3.5	4.5	mA
Conversion Loss	L _C		–	–6.0	–7.5	dB
3rd Order Distortion Input Intercept Point ^{Note}	IIP ₃		+18	+23	–	dBm
3rd Order Intermodulation Distortion	IM ₃		–	–52	–42	dBc
Local Leakage	L _{LO}		–	–13	–11	dBm

Note IIP₃ is determined by comparing two method; theoretical calculation and cross point of IM₃ curve.

$$IIP_3 = \frac{\Delta IM_3 \times P_{RF} + CG - P_{IM3}}{\Delta IM_3 - 1} \text{ [dBm]} \quad \Delta IM_3: P_{IM3} \text{ gradient}$$

Calculated as ΔIM₃ = 3

EVALUATION CIRCUIT

$T_A = +25\text{ }^\circ\text{C}$, $V_{DD} = +2.8\text{ V}$, $f = 850\text{ MHz}$

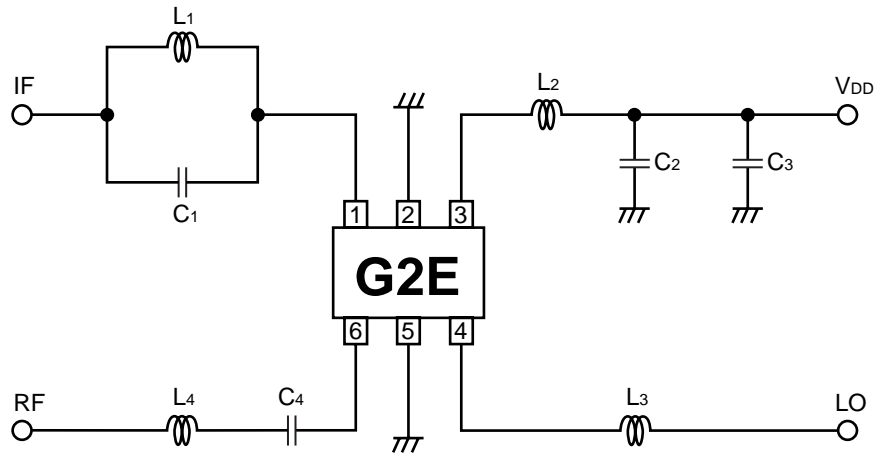

EVALUATION BOARD

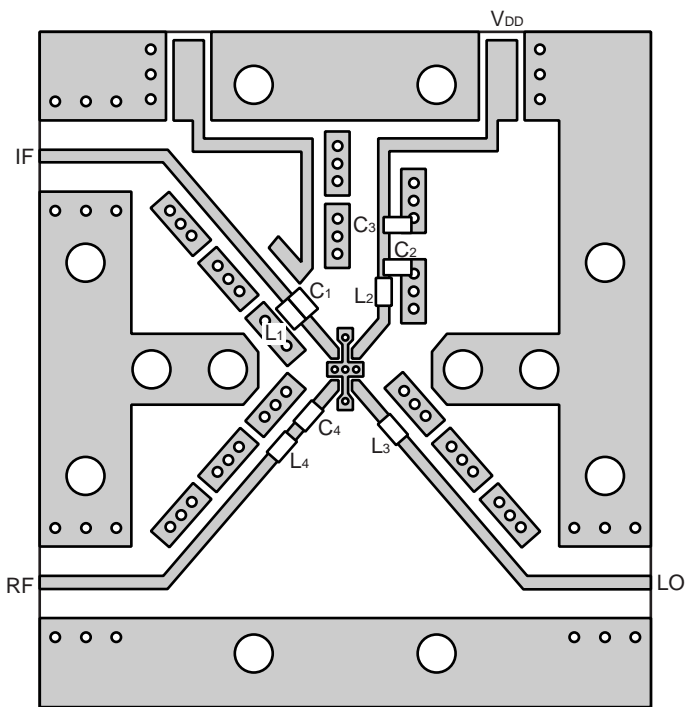

USING THE NEC EVALUATION BOARD

	Values	Part Number	Maker
C1	5 pF	GRM39CH 050 C50	muRata
C2	33 pF	GRM36CH 330 J50	muRata
C3	1 000 pF	GRM39B 102 K50	muRata
C4	5 pF	GRM39CH 050 C50	muRata
L1	6.8 nH	TFL0510 6N8	susumu
L2	15 nH	TFL0816 15N	susumu
L3	27 nH	TFL0816 27N	susumu
L4	6.8 nH	TFL0816 6N8	susumu

TYPICAL CHARACTERISTICS (Unless otherwise specified, T_A = +25 °C)

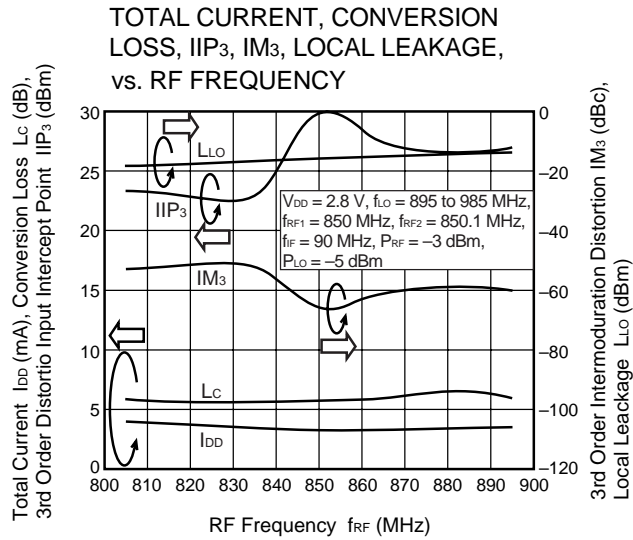
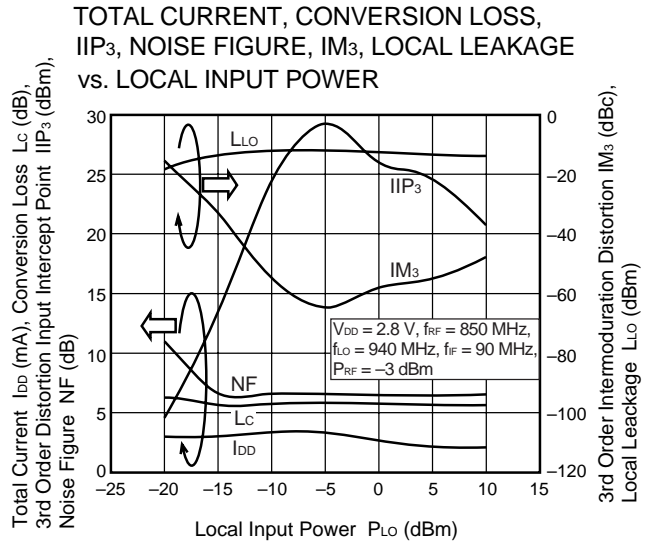
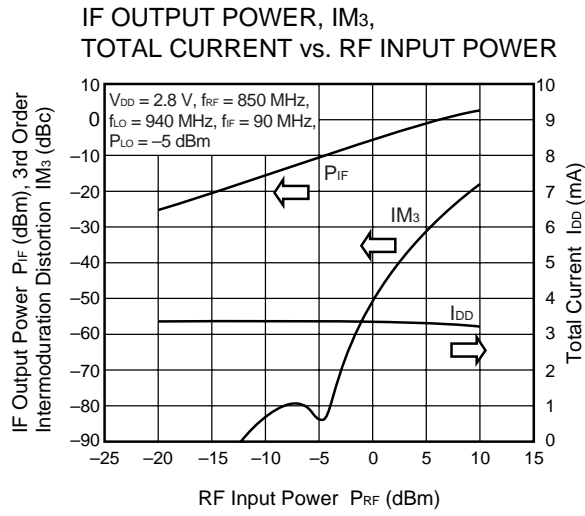

Remark The graphs indicate nominal characteristics.

PACKAGE DIMENSIONS

6-PIN SUPER MINIMOLD (UNIT: mm)

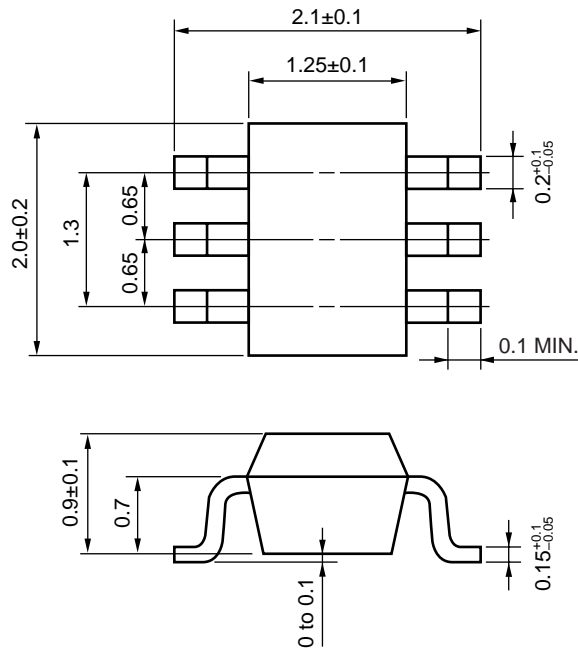

RECOMMENDED SOLDERING CONDITIONS

This product should be soldered under the following recommended conditions. For soldering methods and conditions other than those recommended below, contact your NEC sales representative.

Soldering Method	Soldering Conditions	Recommended Condition Symbol
Infrared Reflow	Package peak temperature: 235 °C or below Time: 30 seconds or less (at 210 °C) Count: 3, Exposure limit: None ^{Note}	IR35-00-3
VPS	Package peak temperature: 215 °C or below Time: 40 seconds or less (at 200 °C) Count: 3, Exposure limit: None ^{Note}	VP15-00-3
Wave Soldering	Soldering bath temperature: 260 °C or below Time: 10 seconds or less Count: 1, Exposure limit: None ^{Note}	WS60-00-1
Partial Heating	Pin temperature: 300 °C Time: 3 seconds or less (per side of device) Exposure limit: None ^{Note}	–

Note After opening the dry pack, keep it in a place below 25 °C and 65 % RH for the allowable storage period.

Caution Do not use different soldering methods together (except for partial heating).

For details of recommended soldering conditions for surface mounting, refer to information document SEMICONDUCTOR DEVICE MOUNTING TECHNOLOGY MANUAL (C10535E).

CAUTION

**The great care must be taken in dealing with the devices in this guide.
The reason is that the material of the devices is GaAs (Gallium Arsenide), which is
designated as harmful substance according to the law concerned.
Keep the law concerned and so on, especially in case of removal.**

- **The information in this document is current as of July, 2000. The information is subject to change without notice. For actual design-in, refer to the latest publications of NEC's data sheets or data books, etc., for the most up-to-date specifications of NEC semiconductor products. Not all products and/or types are available in every country. Please check with an NEC sales representative for availability and additional information.**
 - No part of this document may be copied or reproduced in any form or by any means without prior written consent of NEC. NEC assumes no responsibility for any errors that may appear in this document.
 - NEC does not assume any liability for infringement of patents, copyrights or other intellectual property rights of third parties by or arising from the use of NEC semiconductor products listed in this document or any other liability arising from the use of such products. No license, express, implied or otherwise, is granted under any patents, copyrights or other intellectual property rights of NEC or others.
 - Descriptions of circuits, software and other related information in this document are provided for illustrative purposes in semiconductor product operation and application examples. The incorporation of these circuits, software and information in the design of customer's equipment shall be done under the full responsibility of customer. NEC assumes no responsibility for any losses incurred by customers or third parties arising from the use of these circuits, software and information.
 - While NEC endeavours to enhance the quality, reliability and safety of NEC semiconductor products, customers agree and acknowledge that the possibility of defects thereof cannot be eliminated entirely. To minimize risks of damage to property or injury (including death) to persons arising from defects in NEC semiconductor products, customers must incorporate sufficient safety measures in their design, such as redundancy, fire-containment, and anti-failure features.
 - NEC semiconductor products are classified into the following three quality grades:
"Standard", "Special" and "Specific". The "Specific" quality grade applies only to semiconductor products developed based on a customer-designated "quality assurance program" for a specific application. The recommended applications of a semiconductor product depend on its quality grade, as indicated below. Customers must check the quality grade of each semiconductor product before using it in a particular application.
"Standard": Computers, office equipment, communications equipment, test and measurement equipment, audio and visual equipment, home electronic appliances, machine tools, personal electronic equipment and industrial robots
"Special": Transportation equipment (automobiles, trains, ships, etc.), traffic control systems, anti-disaster systems, anti-crime systems, safety equipment and medical equipment (not specifically designed for life support)
"Specific": Aircraft, aerospace equipment, submersible repeaters, nuclear reactor control systems, life support systems and medical equipment for life support, etc.
- The quality grade of NEC semiconductor products is "Standard" unless otherwise expressly specified in NEC's data sheets or data books, etc. If customers wish to use NEC semiconductor products in applications not intended by NEC, they must contact an NEC sales representative in advance to determine NEC's willingness to support a given application.
- (Note)
- (1) "NEC" as used in this statement means NEC Corporation and also includes its majority-owned subsidiaries.
(2) "NEC semiconductor products" means any semiconductor product developed or manufactured by or for NEC (as defined above).