



NEC's 1.5W L, S-BAND SPDT SWITCH

UPG2179TB

FEATURES

- **SWITCH CONTROL VOLTAGE:**
 $V_{cont} (H) = 2.5 \text{ to } 5.3 \text{ V (3.0 V TYP.)}$
 $V_{cont} (L) = -0.2 \text{ to } +0.2 \text{ V (0 V TYP.)}$
- **LOW INSERTION LOSS:**
 0.25 dB TYP. @ 0.5 to 1.0 GHz, $V_{cont} = 3.0 \text{ V/0 V}$
 0.30 dB TYP. @ 1.0 to 2.0 GHz, $V_{cont} = 3.0 \text{ V/0 V}$
 0.35 dB TYP. @ 2.0 to 2.5 GHz, $V_{cont} = 3.0 \text{ V/0 V}$
 0.40 dB TYP. @ 2.0 to 3.0 GHz, $V_{cont} = 3.0 \text{ V/0 V}$
- **HIGH ISOLATION:**
 27 dB TYP. @ 0.5 to 2.0 GHz, $V_{cont} = 3.0 \text{ V/0 V}$
 24 dB TYP. @ 2.0 to 2.5 GHz, $V_{cont} = 3.0 \text{ V/0 V}$
- **HIGH POWER:**
 $P_{in} (0.1 \text{ dB}) = +29.0 \text{ dBm TYP. @ } 0.5 \text{ to } 3.0 \text{ GHz, } V_{cont} = 3.0 \text{ V/0 V}$
 $P_{in} (1 \text{ dB}) = +32.0 \text{ dBm TYP. @ } 0.5 \text{ to } 3.0 \text{ GHz, } V_{cont} = 3.0 \text{ V/0 V}$
- **HIGH-DENSITY SURFACE MOUNT PACKAGE:**
 6-pin super minimold package (2.0 × 1.25 × 0.9 mm)
- **PB-FREE**

DESCRIPTION

NEC's UPG2179TB is a GaAs MMIC L, S-band SPDT (Single Pole Double Throw) switch for mobile phone and L, S-band applications from 0.5 to 3.0 GHz.

This device can operate with 2.5 to 5.3 V from 50 MHz to 3 GHz with low insertion loss and high isolation.

The UPG2179TB is housed in a Pb-Free 6-pin super minimold package suitable for high-density surface mounting.

APPLICATIONS

- L, S-band digital cellular and cordless telephones
- PCS, W-LAN, WLL and Bluetooth™
- Short Range Wireless

ORDERING INFORMATION

PART NUMBER	PACKAGE	MARKING	SUPPLYING FORM
UPG2179TB-E4-A	6-pin super minimold	G4C	<ul style="list-style-type: none"> • Embossed tape 8 mm wide • Pin 4, 5, 6 face the perforation side of the tape • Qty 3 kpcs/reel

Remark To order evaluation samples, contact your nearby sales office.
 Part number for sample order: UPG2179TB-A

Caution Observe precautions when handling because these devices are sensitive to electrostatic discharge.

PIN CONNECTIONS AND INTERNAL BLOCK DIAGRAM

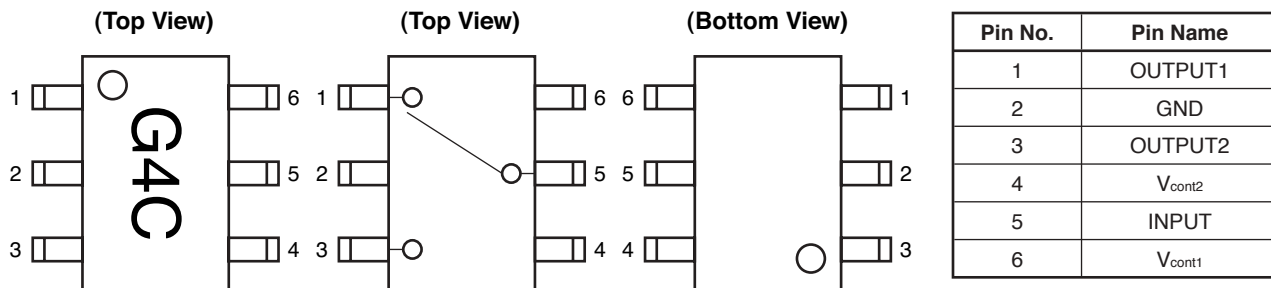

TRUTH TABLE

V _{CONT1}	V _{CONT2}	INPUT-OUTPUT1	INPU-OUTPUT2
Low	High	ON	OFF
High	Low	OFF	ON

ABSOLUTE MAXIMUM RATINGS (T_A = 25°C, unless otherwise specified)

PARAMETER	SYMBOL	RATINGS	UNIT
Switch Control Voltage	V _{cont}	6.0	V
Input Power	P _{in}	+33	dBm
Operating Ambient Temperature	T _A	-45 to +85	°C
Storage Temperature	T _{stg}	-55 to +150	°C

Note |V_{cont1} - V_{cont2}| ≤ 6.0 V

RECOMMENDED OPERATING RANGE (T_A = 25°C, unless otherwise specified)

PARAMETER	SYMBOL	MIN.	TYP.	MAX.	UNIT
Switch Control Voltage (H)	V _{cont (H)}	2.5	3.0	5.3	V
Switch Control Voltage (L)	V _{cont (L)}	-0.2	0	0.2	V

ELECTRICAL CHARACTERISTICS

(TA = +25°C, V_{cont} = 3.0 V/0V, DC blocking capacitors = 100 pF, unless otherwise specified)

PARAMETER	SYMBOL	TEST CONDITIONS	MIN.	TYP.	MAX.	UNIT
Insertion Loss 1	L _{INS1}	f = 0.5 to 1.0 GHz Note1	-	0.25	0.45	dB
Insertion Loss 2	L _{INS2}	f = 1.0 to 2.0 GHz	-	0.30	0.50	dB
Insertion Loss 3	L _{INS3}	f = 2.0 to 2.5 GHz	-	0.35	0.55	dB
Insertion Loss 4	L _{INS4}	f = 2.5 to 3.0 GHz	-	0.40	0.60	dB
Isolation 1	ISL ₁	f = 0.5 to 2.0 GHz Note1	23	27	-	dB
Isolation 2	ISL ₂	f = 2.0 to 3.0 GHz	20	24	-	dB
Input Return Loss	RL _{in}	f = 0.5 to 3.0 GHz Note1	15	20	-	dB
Output Return Loss	RL _{out}	f = 0.5 to 3.0 GHz Note1	15	20	-	dB
0.1 dB Loss Compression	P _{in (0.1 dB)}	f = 2.0 GHz	+25.5	+29.0	-	dBm
Input Power Note2		f = 2.5 GHz	+25.5	+29.0	-	dBm
		f = 0.5 to 3.0 GHz	-	+29.0	-	dBm
Switch Control Current	I _{cont}	No signal	-	4	20	μA
Switch Control Speed	t _{sw}	50%CTL to 90/10%RF	-	50	500	ns

Note 1. DC blocking capacitor = 1 000pF at f = 0.05 to 0.5 GHz.

2. P_{in(0.1 dB)} is the measured input power level when the insertion loss increases 0.1 dB more than that of linear range.

STANDARD CHARACTERISTICS FOR REFERENCE

(TA = +25°C, V_{cont} = 3.0 V/0 V, DC blocking capacitors = 100 pF, unless otherwise specified)

PARAMETER	SYMBOL	TEST CONDITIONS	MIN.	TYP.	MAX.	UNIT
1 dB Loss Compression	P _{in (1 dB)}	f = 0.5 to 3.0 GHz	-	+32.0	-	dBm
Input Power Note						
3rd Order Intermodulation Intercept Point	IIP ₃	f = 0.5 to 3.0 GHz, 2 tone, 5 MHz spacing	-	+60.0	-	dBm

Note P_{in (1 dB)} is the measured input power level when the insertion loss increases 1 dB more than that of linear range.

Caution It is necessary to use DC blocking capacitors with this device.

The value of DC blocking capacitors should be chosen to accommodate the frequency of operation, bandwidth, switching speed and the condition with the actual board of your system. The range of recommended DC blocking capacitor value is less than 100 pF for frequencies above 0.5 GHz, and 1,000 pF for frequencies below 0.5 GHz.

EVALUATION CIRCUIT

($V_{cont1} = 3.0\text{ V}$, $V_{cont2} = 0\text{ V}$ or $V_{cont2} = 0\text{ V}$, $V_{cont1} = 3.0\text{ V}$, off chip DC blocking capacitors value $C1 = 51\text{ pF}$, $C2 = 1\ 000\text{ pF}$ (Bypass), using NEC standard evaluation board)

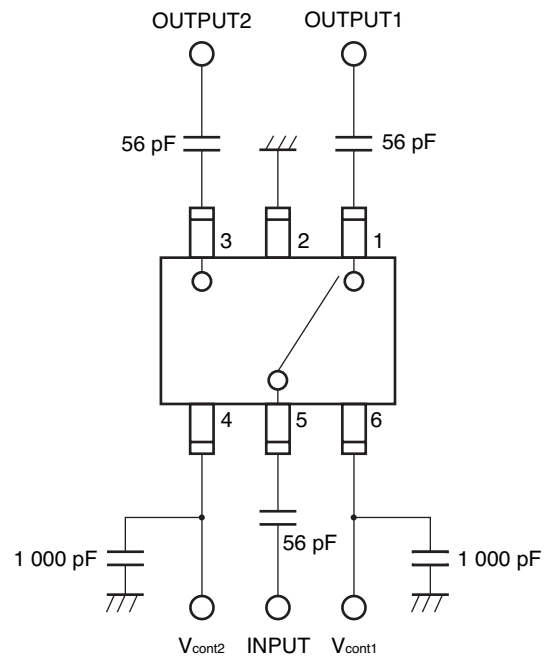

This application circuits and their parameters are for reference only and are not intended for use in actual design-ins.

ILLUSTRATION OF TEST CIRCUIT ASSEMBLED ON EVALUATION BOARD

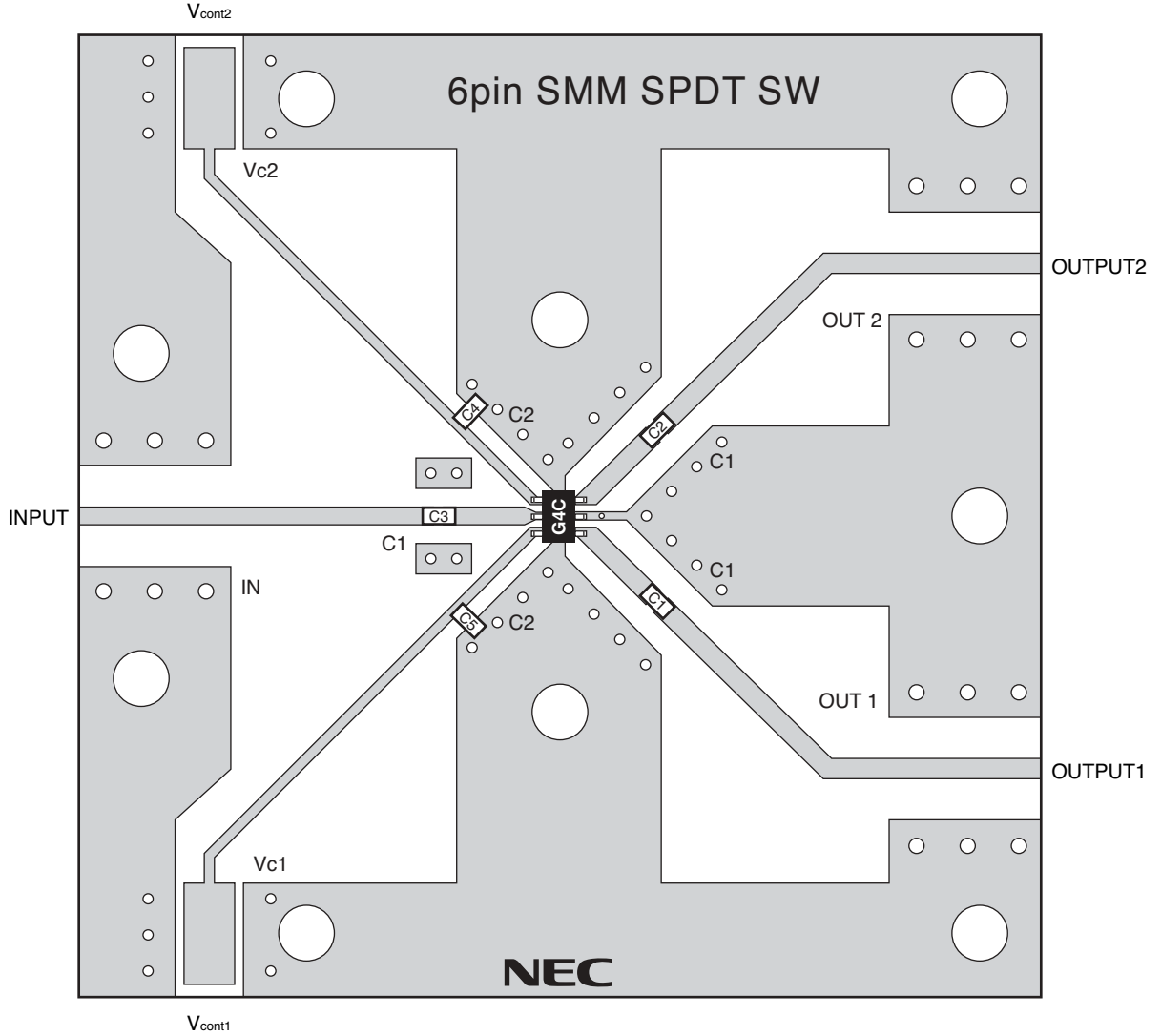

USING THE NEC EVALUATION BOARD

SYMBOL	VALUES
C1, C2, C3	100 pF
C4, C5	1 000 pF

TYPICAL CHARACTERISTICS

(TA = +25°C, Vcont = 3.0 V/0 V, DC blocking capacitors = 100 pF, unless otherwise specified)

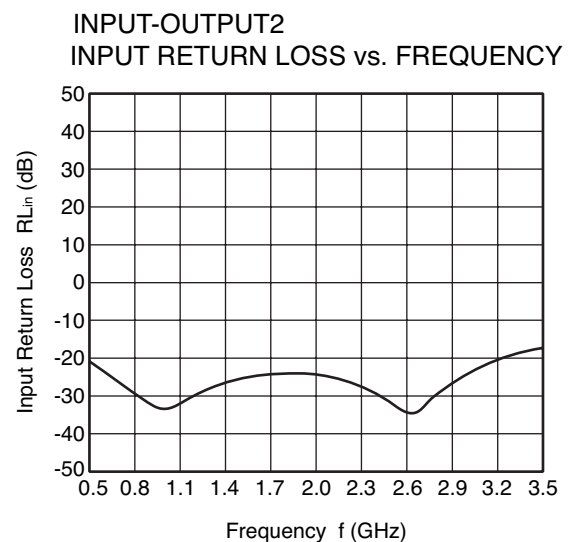
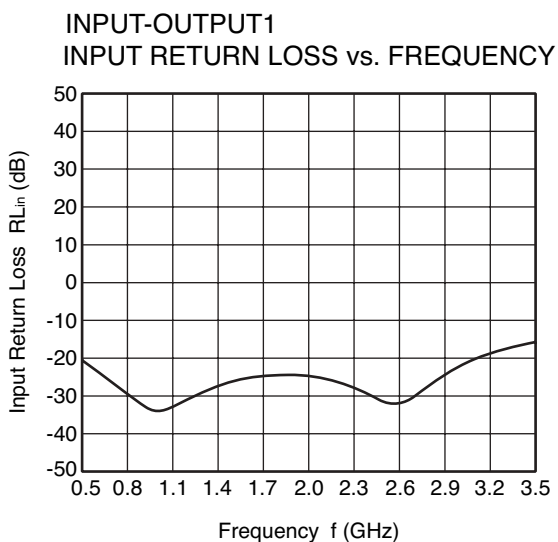
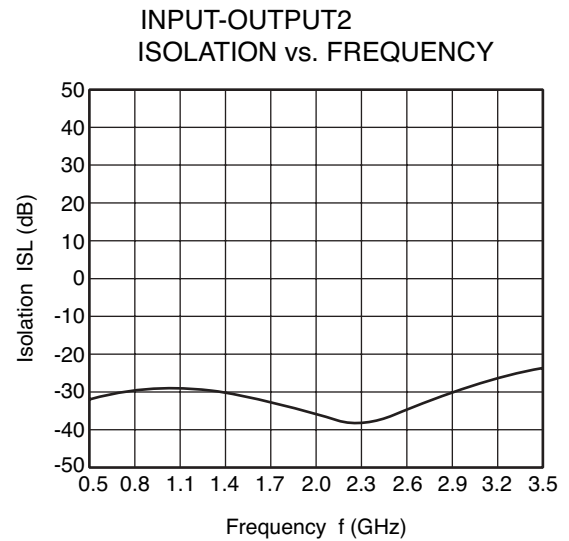
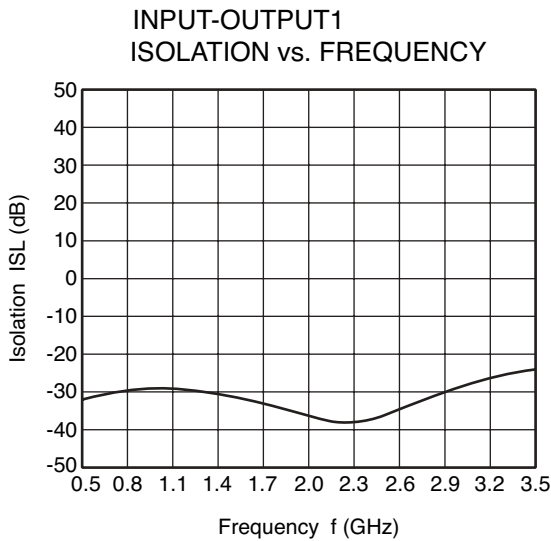
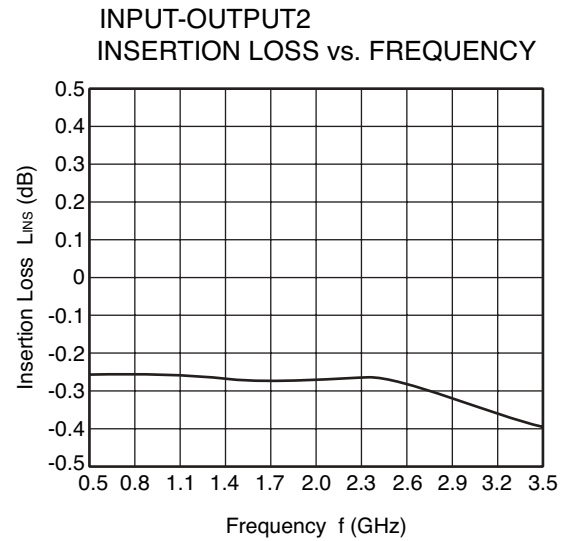
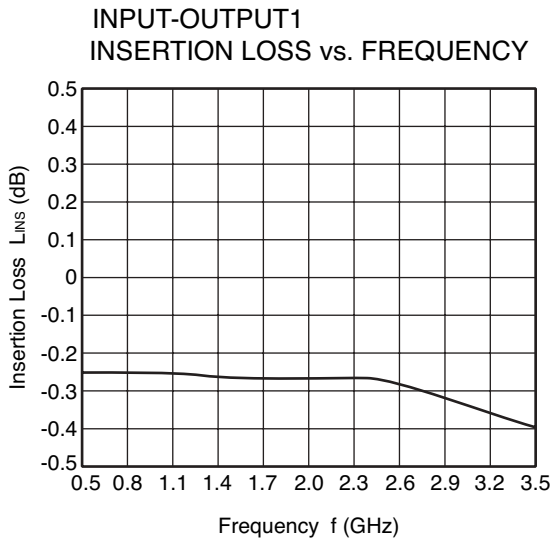

Remark The graphs indicate nominal characteristics.

INPUT-OUTPUT1
OUTPUT RETURN LOSS vs. FREQUENCY

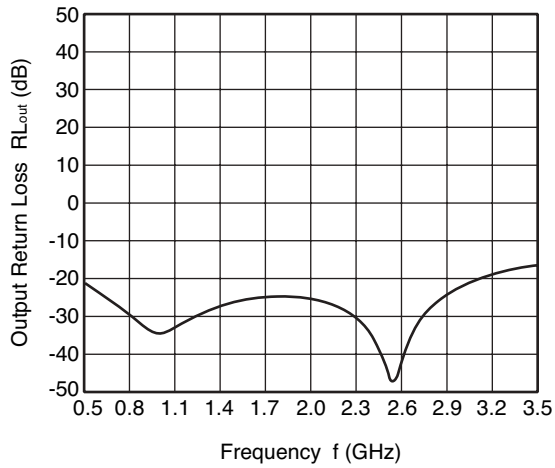

INPUT-OUTPUT2
OUTPUT RETURN LOSS vs. FREQUENCY

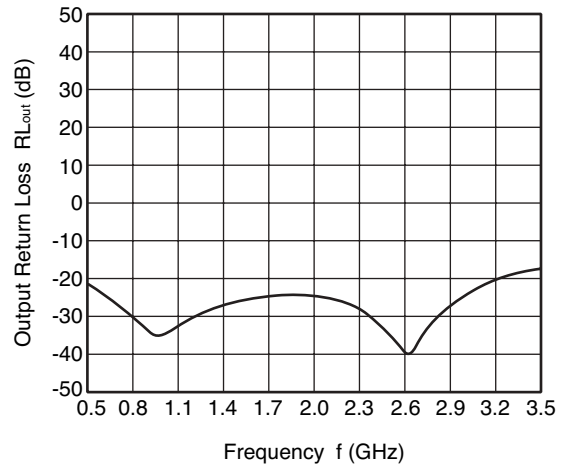

OUTPUT POWER vs. INPUT POWER

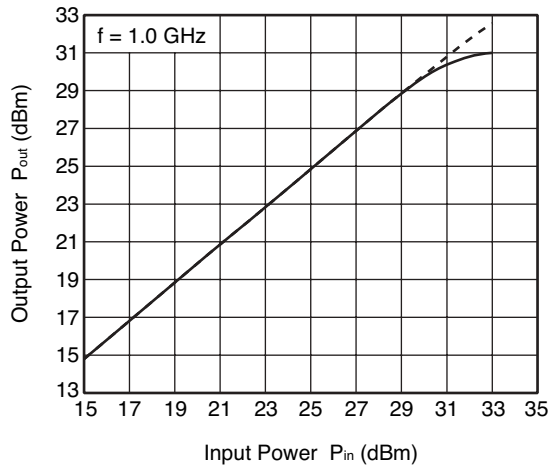

OUTPUT POWER vs. INPUT POWER

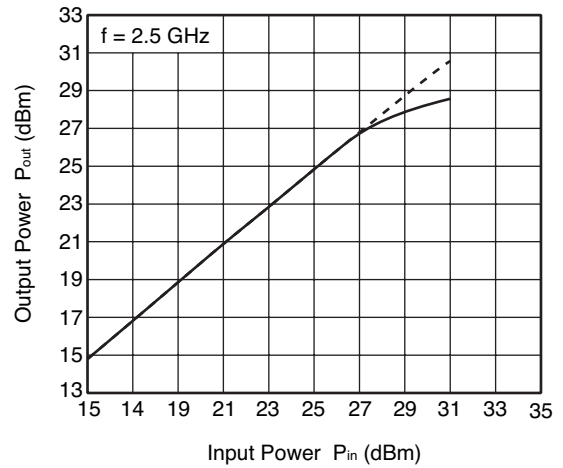

Remark The graphs indicate nominal characteristics.

PACKAGE DIMENSIONS

6-PIN SUPER MINIMOLD (UNIT: mm)

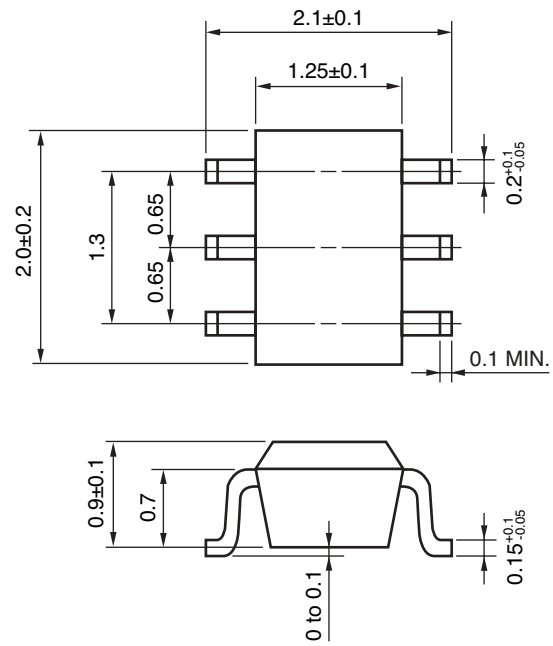

RECOMMENDED SOLDERING CONDITIONS

This product should be soldered and mounted under the following recommended conditions. For soldering methods and conditions other than those recommended below, contact your nearby sales office.

Soldering Method	Soldering Conditions	Condition Symbol
Infrared Reflow	Peak temperature (package surface temperature) : 260°C or below Time at peak temperature : 10 seconds or less Time at temperature of 220°C or higher : 60 seconds or less Preheating time at 120 to 180°C : 120±30 seconds Maximum number of reflow processes : 3 times Maximum chlorine content of rosin flux (% mass) : 0.2%(Wt.) or below	IR260
VPS	Peak temperature (package surface temperature) : 215°C or below Time at temperature of 200°C or higher : 25 to 40 seconds Preheating time at 120 to 150°C : 30 to 60 seconds Maximum number of reflow processes : 3 times Maximum chlorine content of rosin flux (% mass) : 0.2%(Wt.) or below	VP215
Wave Soldering	Peak temperature (molten solder temperature) : 260°C or below Time at peak temperature : 10 seconds or less Preheating temperature (package surface temperature) : 120°C or below Maximum number of flow processes : 1 time Maximum chlorine content of rosin flux (% mass) : 0.2%(Wt.) or below	WS260
Partial Heating	Peak temperature (pin temperature) : 350°C or below Soldering time (per side of device) : 3 seconds or less Maximum chlorine content of rosin flux (% mass) : 0.2%(Wt.) or below	HS350

Caution Do not use different soldering methods together (except for partial heating).

Life Support Applications

These NEC products are not intended for use in life support devices, appliances, or systems where the malfunction of these products can reasonably be expected to result in personal injury. The customers of CEL using or selling these products for use in such applications do so at their own risk and agree to fully indemnify CEL for all damages resulting from such improper use or sale.

CEL California Eastern Laboratories, Your source for NEC RF, Microwave, Optoelectronic, and Fiber Optic Semiconductor Devices.

4590 Patrick Henry Drive • Santa Clara, CA 95054-1817 • (408) 988-3500 • FAX (408) 988-0279 • www.cel.com

DATA SUBJECT TO CHANGE WITHOUT NOTICE

06/01/2004

NEC

A Business Partner of NEC Compound Semiconductor Devices, Ltd.