

HIGH SIDE SMART POWER SOLID STATE RELAY

TYPE	V _{DSS}	R _{DS(on)}	I _{OUT}	V _{CC}
VN02N	60 V	0.4 Ω	6 A	26 V

- OUTPUT CURRENT (CONTINUOUS): 6A @ T_c=25°C
- 5V LOGIC LEVEL COMPATIBLE INPUT
- THERMAL SHUT-DOWN
- UNDER VOLTAGE SHUT-DOWN
- OPEN DRAIN DIAGNOSTIC OUTPUT
- VERY LOW STAND-BY POWER DISSIPATION

DESCRIPTION

The VN02N is a monolithic device made using SGS-THOMSON Vertical Intelligent Power Technology, intended for driving resistive or inductive loads with one side grounded.

Built-in thermal shut-down protects the chip from over temperature and short circuit.

The input control is 5V logic level compatible.

The open drain diagnostic output indicates open circuit (no load) and over temperature status.

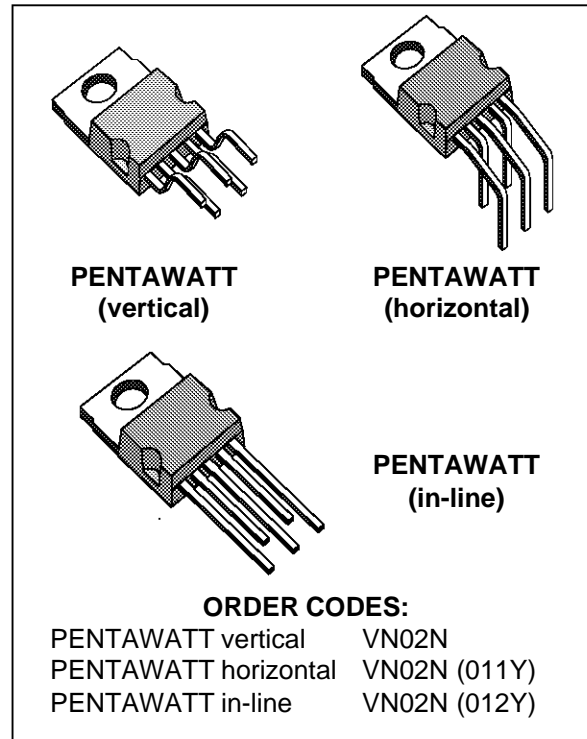

BLOCK DIAGRAM

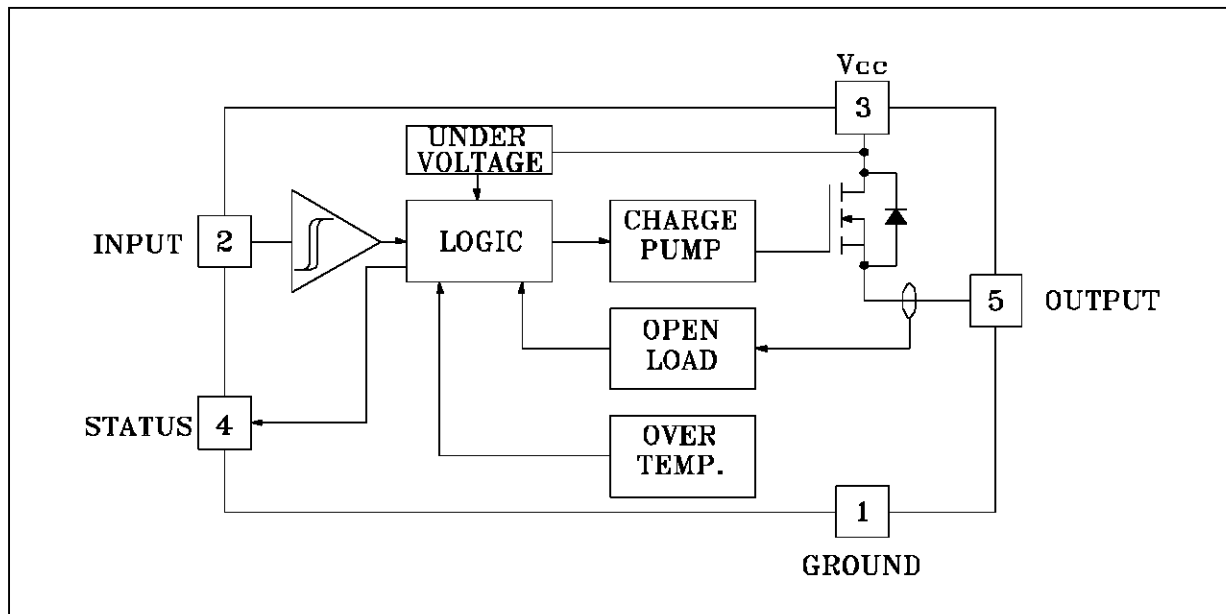

VN02N

ABSOLUTE MAXIMUM RATING

Symbol	Parameter	Value	Unit
$V_{(BR)DSS}$	Drain-Source Breakdown Voltage	60	V
I_{OUT}	Output Current (cont.)	6	A
I_R	Reverse Output Current	-6	A
I_{IN}	Input Current	± 10	mA
$-V_{CC}$	Reverse Supply Voltage	-4	V
I_{STAT}	Status Current	± 10	mA
V_{ESD}	Electrostatic Discharge (1.5 k Ω , 100 pF)	2000	V
P_{tot}	Power Dissipation at $T_c \leq 25^\circ\text{C}$	29	W
T_j	Junction Operating Temperature	-40 to 150	$^\circ\text{C}$
T_{stg}	Storage Temperature	-55 to 150	$^\circ\text{C}$

CONNECTION DIAGRAM

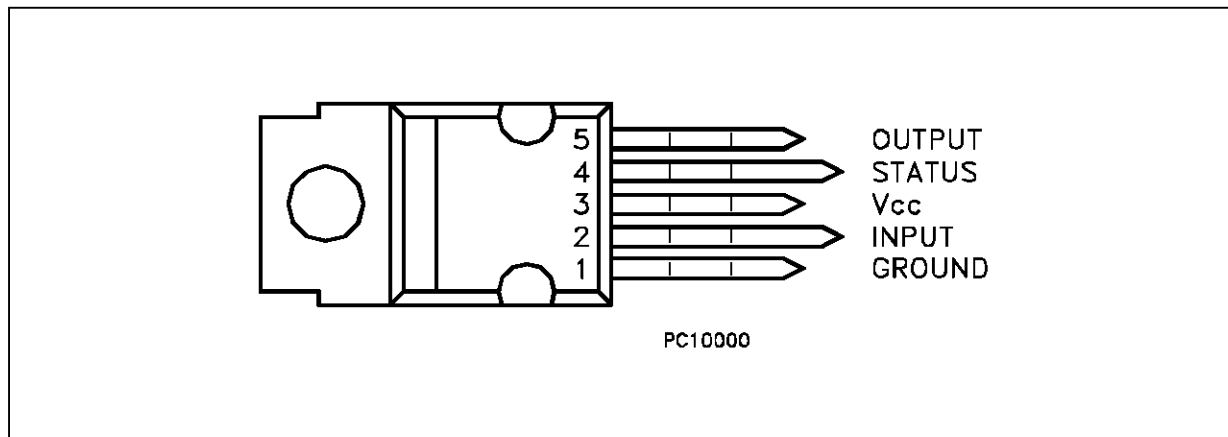

CURRENT AND VOLTAGE CONVENTIONS

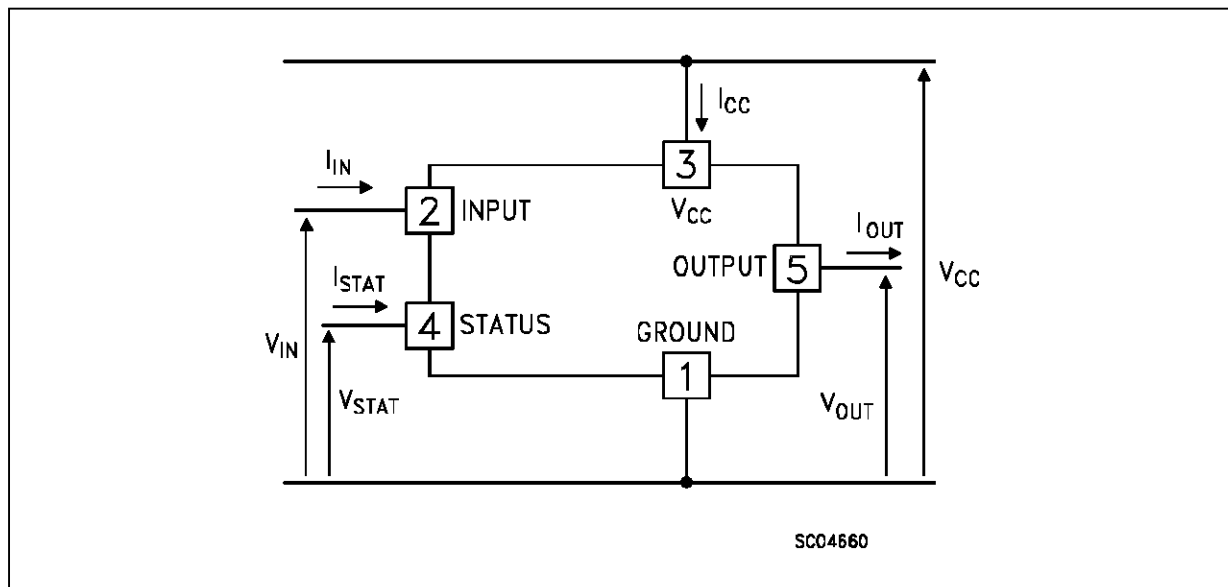

THERMAL DATA

$R_{thj-case}$	Thermal Resistance Junction-case	Max	4.35	$^{\circ}C/W$
$R_{thj-amb}$	Thermal Resistance Junction-ambient	Max	60	$^{\circ}C/W$

ELECTRICAL CHARACTERISTICS ($V_{CC} = 13 V$; $-40 \leq T_j \leq 125 ^{\circ}C$ unless otherwise specified)

POWER

Symbol	Parameter	Test Conditions	Min.	Typ.	Max.	Unit
V_{CC}	Supply Voltage		7		26	V
R_{on}	On State Resistance	$I_{OUT} = 3 A$ $I_{OUT} = 3 A$ $T_j = 25 ^{\circ}C$			0.8 0.4	Ω Ω
I_S	Supply Current	Off State $T_j \geq 25 ^{\circ}C$ On State			50 15	μA mA

SWITCHING

Symbol	Parameter	Test Conditions	Min.	Typ.	Max.	Unit
$t_{d(on)}$	Turn-on Delay Time Of Output Current	$I_{OUT} = 3 A$ Resistive Load Input Rise Time $< 0.1 \mu s$ $T_j = 25 ^{\circ}C$		10		μs
t_r	Rise Time Of Output Current	$I_{OUT} = 3 A$ Resistive Load Input Rise Time $< 0.1 \mu s$ $T_j = 25 ^{\circ}C$		15		μs
$t_{d(off)}$	Turn-off Delay Time Of Output Current	$I_{OUT} = 3 A$ Resistive Load Input Rise Time $< 0.1 \mu s$ $T_j = 25 ^{\circ}C$		15		μs
t_f	Fall Time Of Output Current	$I_{OUT} = 3 A$ Resistive Load Input Rise Time $< 0.1 \mu s$ $T_j = 25 ^{\circ}C$		6		μs
$(di/dt)_{on}$	Turn-on Current Slope	$I_{OUT} = 3 A$ $I_{OUT} = I_{OV}$			0.5 2	$A/\mu s$ $A/\mu s$
$(di/dt)_{off}$	Turn-off Current Slope	$I_{OUT} = 3 A$ $I_{OUT} = I_{OV}$			2 4	$A/\mu s$ $A/\mu s$

LOGIC INPUT

Symbol	Parameter	Test Conditions	Min.	Typ.	Max.	Unit
V_{IL}	Input Low Level Voltage				0.8	V
V_{IH}	Input High Level Voltage		2		(*)	V
$V_{I(hyst.)}$	Input Hysteresis Voltage			0.5		V
I_{IN}	Input Current	$V_{IN} = 5 V$		250	500	μA
V_{ICL}	Input Clamp Voltage	$I_{IN} = 10 mA$ $I_{IN} = -10 mA$		6 -0.7		V V

PROTECTIONS AND DIAGNOSTICS

Symbol	Parameter	Test Conditions	Min.	Typ.	Max.	Unit
$V_{STAT} (\bullet)$	Status Voltage Output Low	$I_{STAT} = 1.6 mA$			0.4	V
V_{USD}	Under Voltage Shut Down			6.5		V

ELECTRICAL CHARACTERISTICS (continued)

PROTECTION AND DIAGNOSTICS (continued)

Symbol	Parameter	Test Conditions	Min.	Typ.	Max.	Unit
V_{SCL} (•)	Status Clamp Voltage	$I_{STAT} = 10 \text{ mA}$ $I_{STAT} = -10 \text{ mA}$		6 -0.7		V V
t_{SC}	Switch-off Time in Short Circuit Condition at Start-Up	$R_{LOAD} < 10 \text{ m}\Omega$ $T_c = 25 \text{ }^\circ\text{C}$		1.5	5	ms
I_{OV}	Over Current	$R_{LOAD} < 10 \text{ m}\Omega$ $-40 \leq T_c \leq 125 \text{ }^\circ\text{C}$			28	A
I_{AV}	Average Current in Short Circuit	$R_{LOAD} < 10 \text{ m}\Omega$ $T_c = 85 \text{ }^\circ\text{C}$		0.9		A
I_{OL}	Open Load Current Level		5		70	mA
T_{TSD}	Thermal Shut-down Temperature		140			$^\circ\text{C}$
T_R	Reset Temperature		125			$^\circ\text{C}$

(*) The V_{IH} is internally clamped at 6V about. It is possible to connect this pin to an higher voltage via an external resistor calculated to not exceed 10 mA at the input pin.

(•) Status determination > 100 μs after the switching edge.

FUNCTIONAL DESCRIPTION

The device has a diagnostic output which indicates open circuit (no load) and over temperature conditions. The output signals are processed by internal logic.

To protect the device against short circuit and over-current condition, the thermal protection turns the integrated Power MOS off at a minimum junction temperature of 140 $^\circ\text{C}$. When the temperature returns to about 125 $^\circ\text{C}$ the switch is automatically turned on again.

In short circuit conditions the protection reacts with virtually no delay, the sensor being located in the region of the die where the heat is generated.

PROTECTING THE DEVICE AGAINST REVERSE BATTERY

The simplest way to protect the device against a continuous reverse battery voltage (-26V) is to insert a Schottky diode between pin 1 (GND) and ground, as shown in the typical application circuit (fig. 3).

The consequences of the voltage drop across this diode are as follows:

- If the input is pulled to power GND, a negative voltage of $-V_F$ is seen by the device. (V_{IL} , V_{IH} thresholds and V_{STAT} are increased by V_F with respect to power GND).
- The undervoltage shutdown level is increased by V_F .

If there is no need for the control unit to handle external analog signals referred to the power GND, the best approach is to connect the reference potential of the control unit to node [1] (see application circuit in fig. 4), which becomes the common signal GND for the whole control board.

In this way no shift of V_{IH} , V_{IL} and V_{STAT} takes place and no negative voltage appears on the INPUT pin; this solution allows the use of a standard diode, with a breakdown voltage able to handle any ISO normalized negative pulses that occurs in the automotive environment.

TRUTH TABLE

	INPUT	OUTPUT	DIAGNOSTIC
Normal Operation	L	L	H
	H	H	H
Open Circuit (No Load)	H	H	L
Over-temperature	H	L	L
Under-voltage	X	L	H

Figure 1: Waveforms

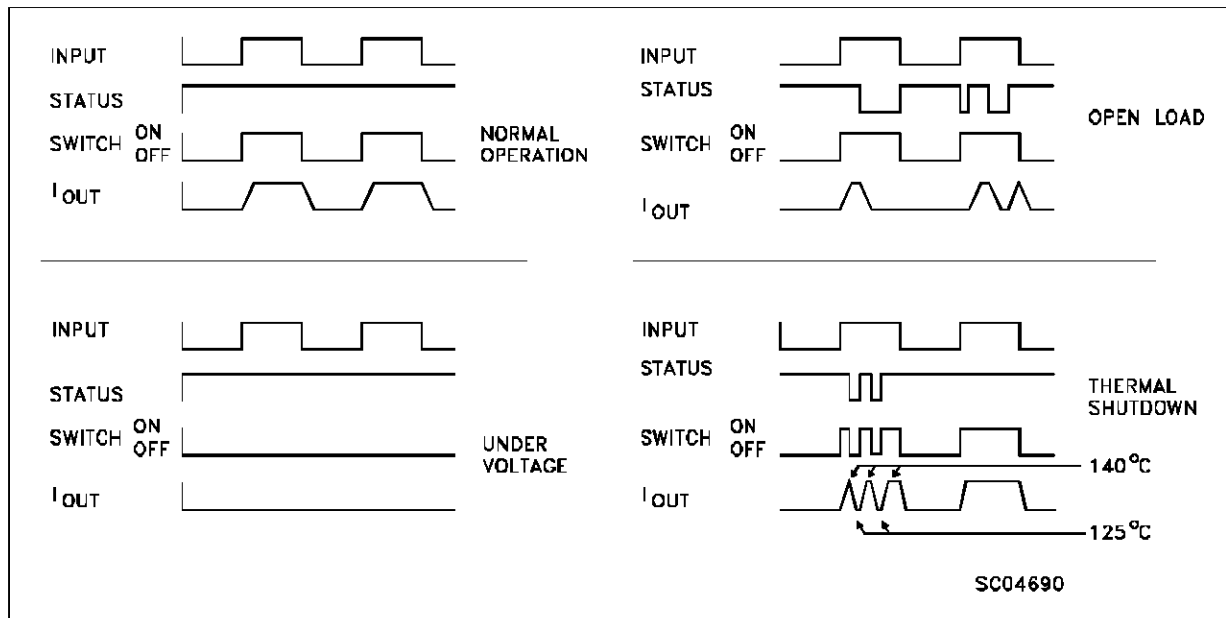

Figure 2: Over Current Test Circuit

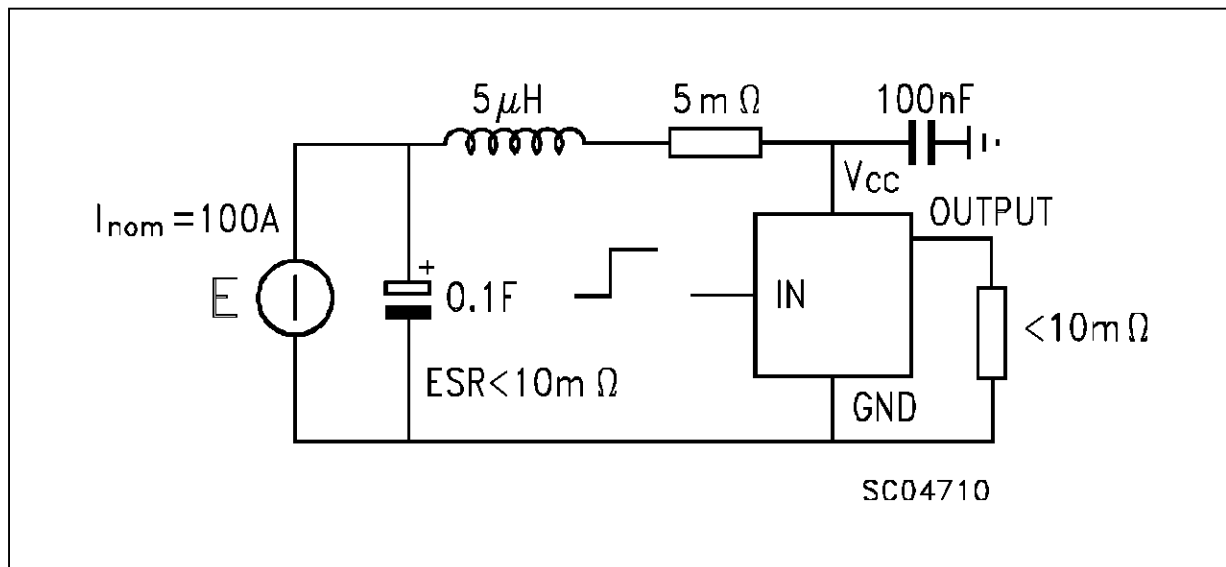

Figure 3: Typical Application Circuit With A Schottky Diode For Reverse Supply Protection

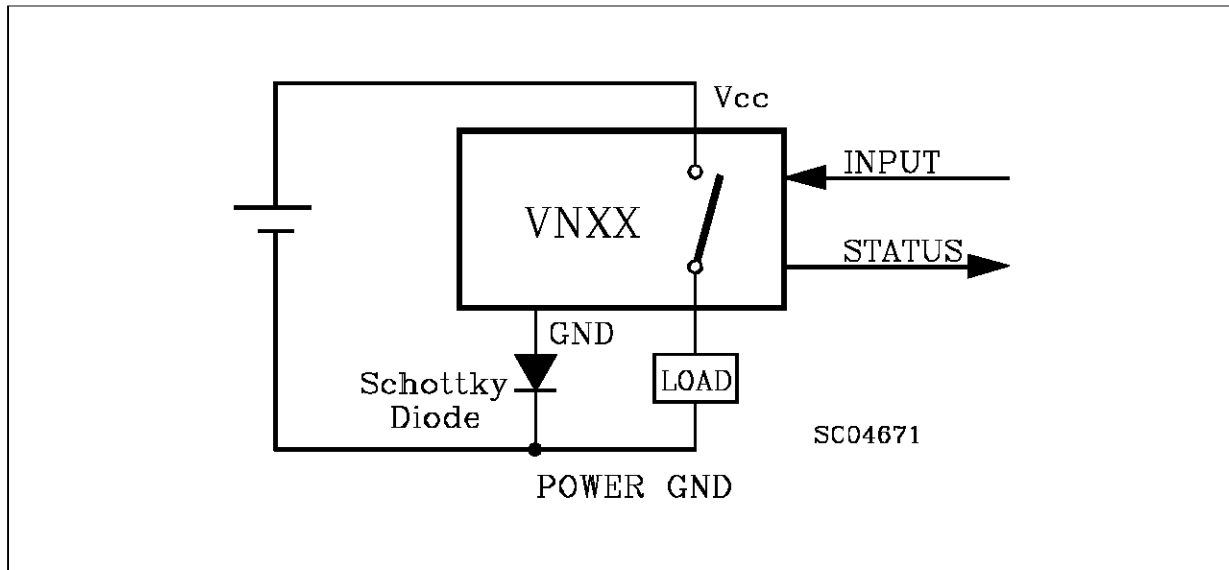
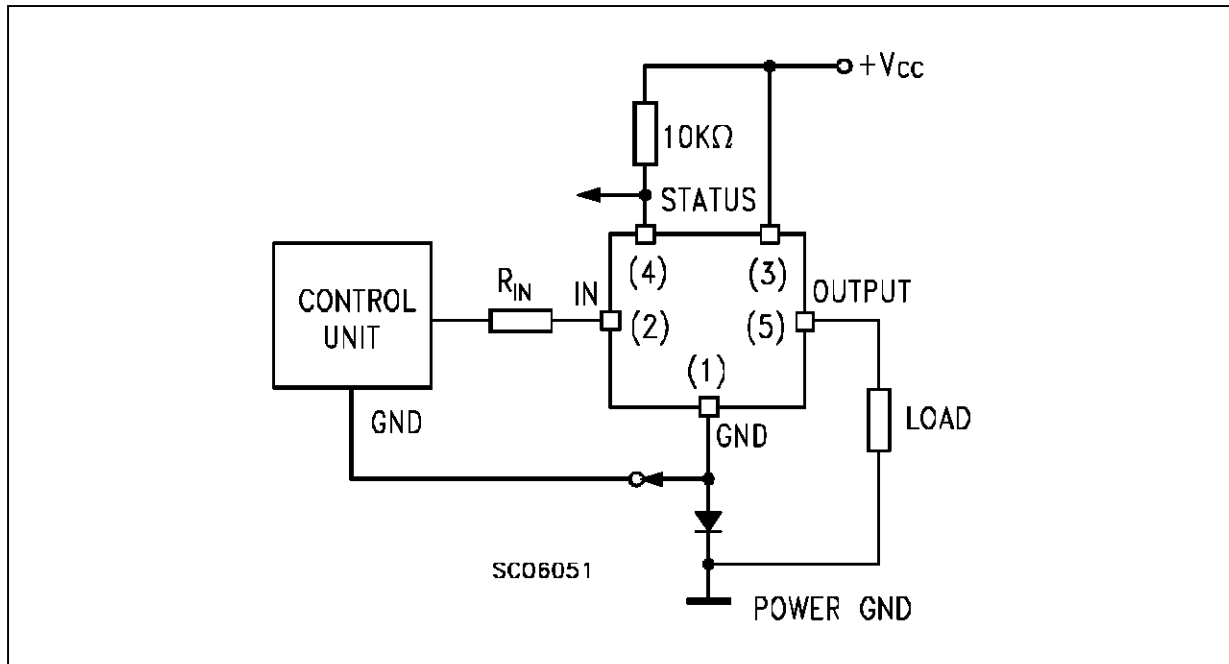
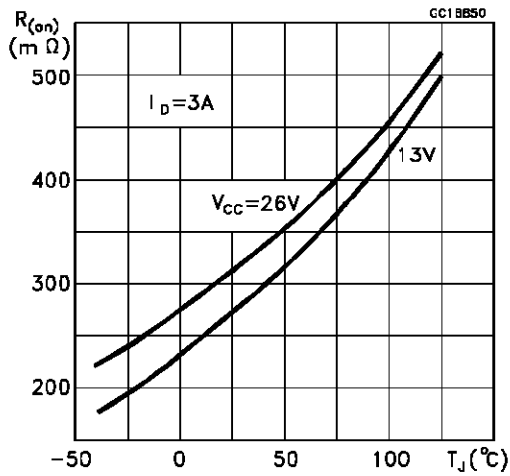

Figure 4: Typical Application Circuit With Separate Signal Ground



R_{DS(on)} vs Junction Temperature



R_{DS(on)} vs Supply Voltage

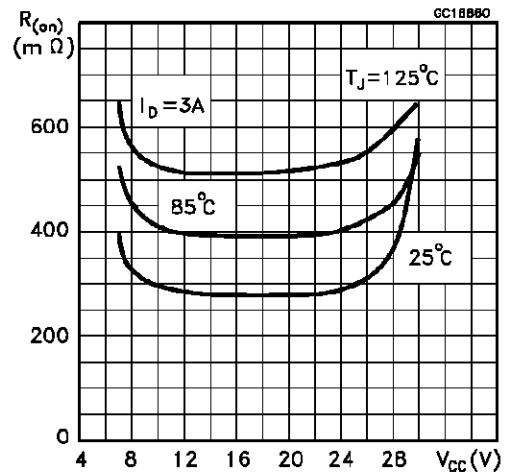

R_{DS(on)} vs Output Current

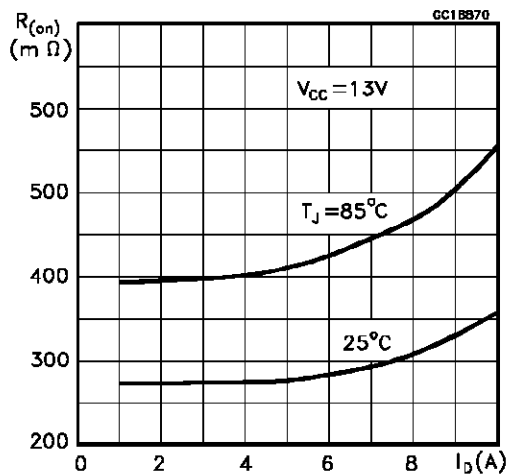

Input voltages vs Junction Temperature

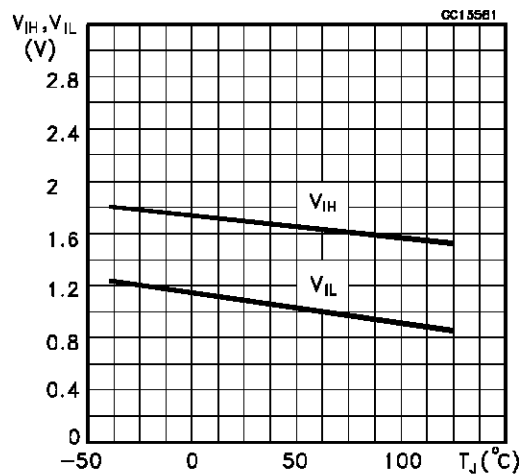

Output Current Derating

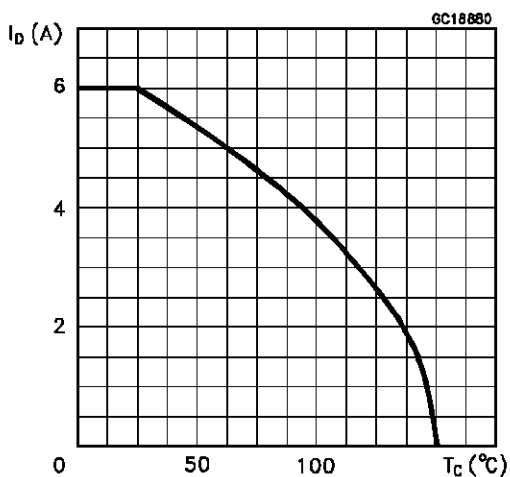

Open Load vs Junction Temperature

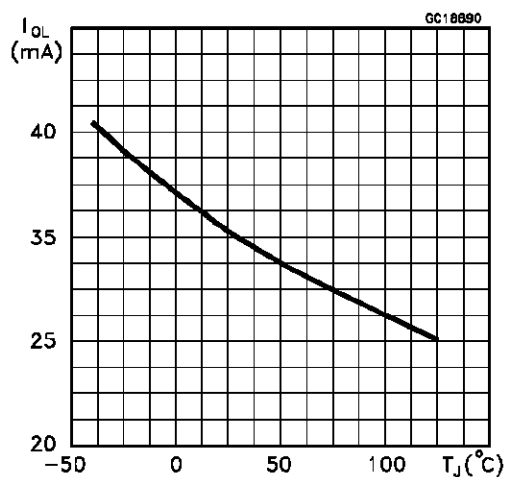

Pentawatt (vertical) MECHANICAL DATA

DIM.	mm			inch		
	MIN.	TYP.	MAX.	MIN.	TYP.	MAX.
A			4.8			0.189
C			1.37			0.054
D	2.4		2.8	0.094		0.110
D1	1.2		1.35	0.047		0.053
E	0.35		0.55	0.014		0.022
F	0.8		1.05	0.031		0.041
F1	1		1.4	0.039		0.055
G	3.2	3.4	3.6	0.126	0.134	0.142
G1	6.6	6.8	7	0.260	0.268	0.276
H2			10.4			0.409
H3	10.05		10.4	0.396		0.409
L		17.85			0.703	
L1		15.75			0.620	
L2		21.4			0.843	
L3		22.5			0.886	
L5	2.6		3	0.102		0.118
L6	15.1		15.8	0.594		0.622
L7	6		6.6	0.236		0.260
M		4.5			0.177	
M1		4			0.157	
Dia	3.65		3.85	0.144		0.152

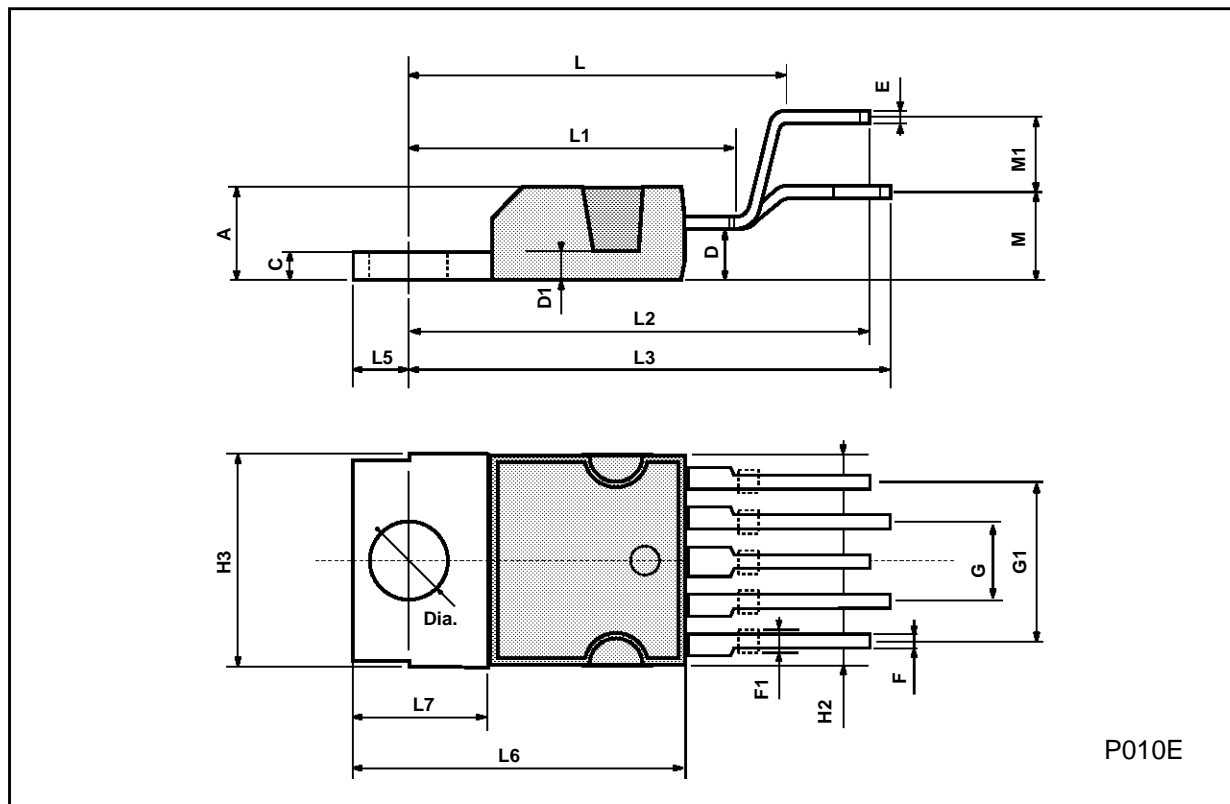

Pentawatt (horizontal) MECHANICAL DATA

DIM.	mm			inch		
	MIN.	TYP.	MAX.	MIN.	TYP.	MAX.
A			4.8			0.189
C			1.37			0.054
D	2.4		2.8	0.094		0.110
D1	1.2		1.35	0.047		0.053
E	0.35		0.55	0.014		0.022
F	0.8		1.05	0.031		0.041
F1	1		1.4	0.039		0.055
G	3.2	3.4	3.6	0.126	0.134	0.142
G1	6.6	6.8	7	0.260	0.268	0.276
H2			10.4			0.409
H3	10.05		10.4	0.396		0.409
L	14.2		15	0.559		0.590
L1	5.7		6.2			0.244
L2	14.6		15.2			0.598
L3	3.5		4.1	0.137		0.161
L5	2.6		3	0.102		0.118
L6	15.1		15.8	0.594		0.622
L7	6		6.6	0.236		0.260
Dia	3.65		3.85	0.144		0.152

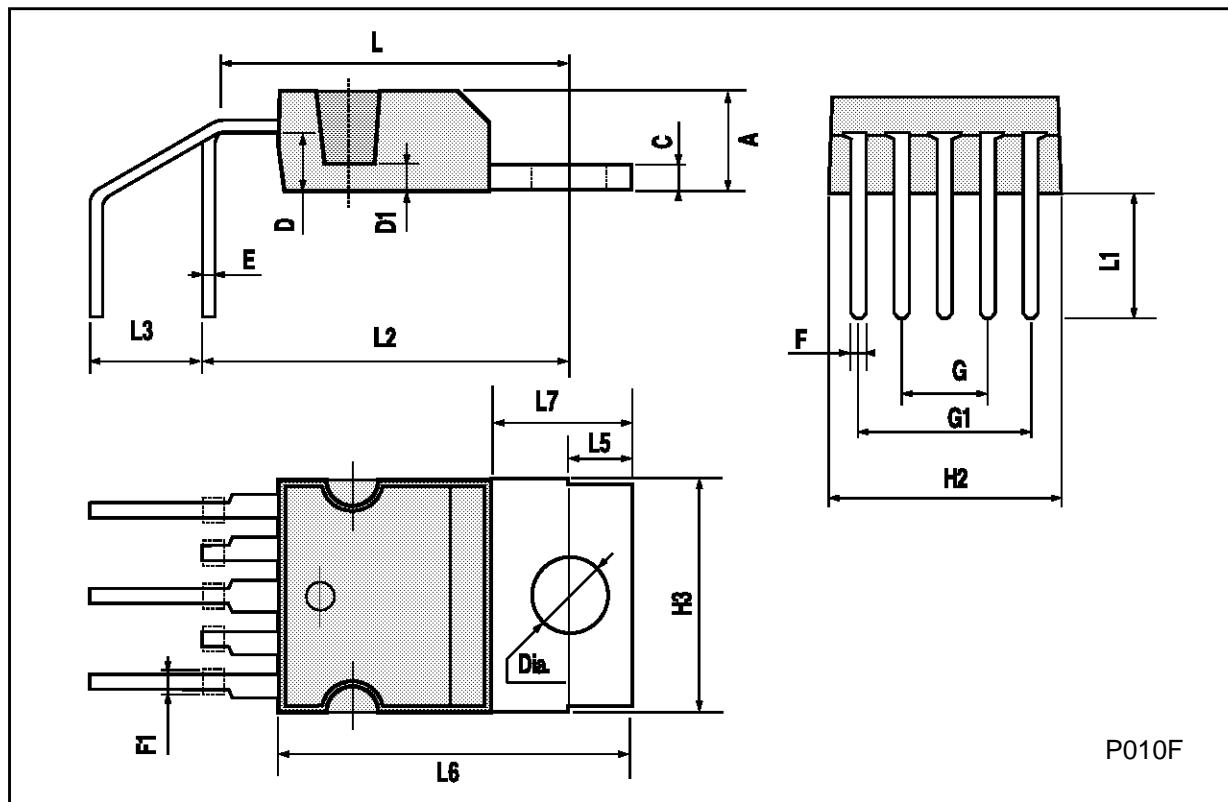

Pentawatt (In-Line) MECHANICAL DATA

DIM.	mm			inch		
	MIN.	TYP.	MAX.	MIN.	TYP.	MAX.
A			4.8			0.189
C			1.37			0.054
D	2.4		2.8	0.094		0.110
D1	1.2		1.35	0.047		0.053
E	0.35		0.55	0.014		0.022
F	0.8		1.05	0.031		0.041
F1	1		1.4	0.039		0.055
G	3.2	3.4	3.6	0.126	0.134	0.142
G1	6.6	6.8	7	0.260	0.268	0.276
H2			10.4			0.409
H3	10.05		10.4	0.396		0.409
L2	23.05	23.4	23.8	0.907	0.921	0.937
L3	25.3	25.65	26.1	0.996	1.010	1.028
L5	2.6		3	0.102		0.118
L6	15.1		15.8	0.594		0.622
L7	6		6.6	0.236		0.260
Dia	3.65		3.85	0.144		0.152

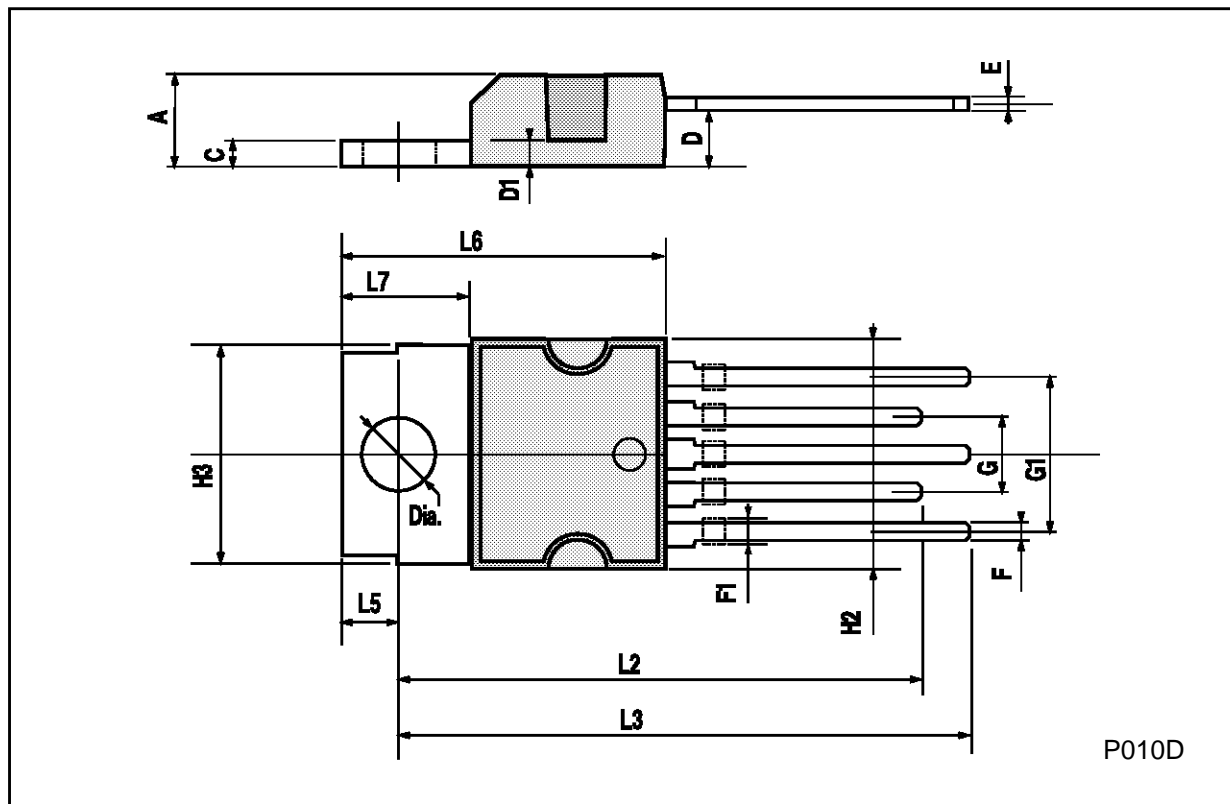

Information furnished is believed to be accurate and reliable. However, SGS-THOMSON Microelectronics assumes no responsibility for the consequences of use of such information nor for any infringement of patents or other rights of third parties which may result from its use. No license is granted by implication or otherwise under any patent or patent rights of SGS-THOMSON Microelectronics. Specifications mentioned in this publication are subject to change without notice. This publication supersedes and replaces all information previously supplied. SGS-THOMSON Microelectronics products are not authorized for use as critical components in life support devices or systems without express written approval of SGS-THOMSON Microelectronics.

© 1994 SGS-THOMSON Microelectronics - All Rights Reserved

SGS-THOMSON Microelectronics GROUP OF COMPANIES
Australia - Brazil - France - Germany - Hong Kong - Italy - Japan - Korea - Malaysia - Malta - Morocco - The Netherlands -
Singapore - Spain - Sweden - Switzerland - Taiwan - Thailand - United Kingdom - U.S.A