



# STP14NF06

N-CHANNEL 60V - 0.1Ω - 14A TO-220

STripFET™ POWER MOSFET

TYPE	V <sub>DSS</sub>	R <sub>DS(on)</sub>	I <sub>D</sub>
STP14NF10	60 V	< 0.12 Ω	14 A

- TYPICAL R<sub>DS(on)</sub> = 0.1Ω
- EXCEPTIONAL dv/dt CAPABILITY
- LOW GATE CHARGE AT 100 °C
- APPLICATION ORIENTED CHARACTERIZATION

## DESCRIPTION

This Power MOSFET is the latest development of STMicroelectronics unique "Single Feature Size™" strip-based process. The resulting transistor shows extremely high packing density for low on-resistance, rugged avalanche characteristics and less critical alignment steps therefore a remarkable manufacturing reproducibility.

## APPLICATIONS

- DC-DC & DC-AC CONVERTERS
- MOTOR CONTROL, AUDIO AMPLIFIERS
- HIGH CURRENT, HIGH SPEED SWITCHING
- SOLENOID AND RELAY DRIVERS
- AUTOMOTIVE ENVIRONMENT

## ABSOLUTE MAXIMUM RATINGS

Symbol	Parameter	Value	Unit
V <sub>DS</sub>	Drain-source Voltage (V <sub>GS</sub> = 0)	60	V
V <sub>DGR</sub>	Drain-gate Voltage (R <sub>GS</sub> = 20 kΩ)	60	V
V <sub>GS</sub>	Gate- source Voltage	±20	V
I <sub>D</sub>	Drain Current (continuous) at T <sub>C</sub> = 25°C	14	A
I <sub>D</sub>	Drain Current (continuous) at T <sub>C</sub> = 100°C	10	A
I <sub>DM</sub> (●)	Drain Current (pulsed)	56	A
P <sub>TOT</sub>	Total Dissipation at T <sub>C</sub> = 25°C	45	W
	Derating Factor	0.3	W/°C
dv/dt (1)	Peak Diode Recovery voltage slope	6	V/ns
E <sub>AS</sub> (2)	Single Pulse Avalanche Energy	50	mJ
T <sub>stg</sub>	Storage Temperature	-65 to 175	°C
T <sub>j</sub>	Max. Operating Junction Temperature	175	°C

(●) Pulse width limited by safe operating area

(1) I<sub>SD</sub> ≤ 7A, di/dt ≤ 300A/μs, V<sub>DD</sub> ≤ V<sub>(BR)DSS</sub>, T<sub>j</sub> ≤ T<sub>JMAX</sub>.  
 (2) Starting T<sub>j</sub> = 25°C, I<sub>D</sub> = 114A, V<sub>DD</sub> = 15V

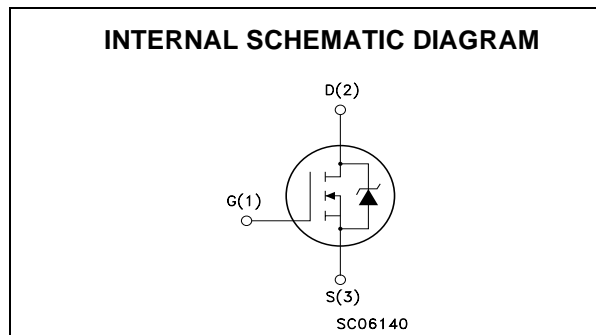
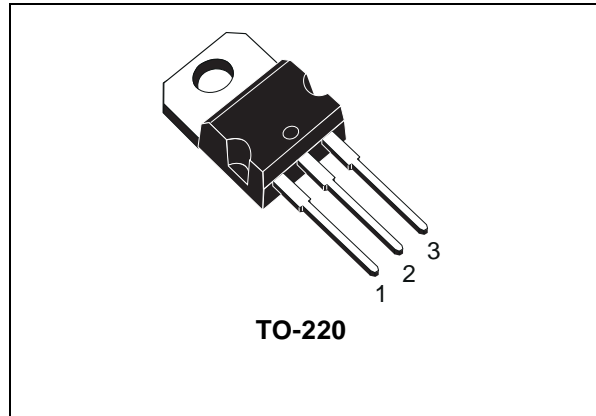

## STP14NF06

### THERMAL DATA

Rthj-case	Thermal Resistance Junction-case Max	3.33	°C/W
Rthj-amb	Thermal Resistance Junction-ambient Max	62.5	°C/W
T <sub>I</sub>	Maximum Lead Temperature For Soldering Purpose	300	°C

### ELECTRICAL CHARACTERISTICS (TCASE = 25 °C UNLESS OTHERWISE SPECIFIED)

OFF

Symbol	Parameter	Test Conditions	Min.	Typ.	Max.	Unit
V <sub>(BR)DSS</sub>	Drain-source Breakdown Voltage	I <sub>D</sub> = 250 μA, V <sub>GS</sub> = 0	60			V
I <sub>DSS</sub>	Zero Gate Voltage Drain Current (V <sub>GS</sub> = 0)	V <sub>DS</sub> = Max Rating V <sub>DS</sub> = Max Rating, T <sub>C</sub> = 125 °C			1 10	μA μA
I <sub>GSS</sub>	Gate-body Leakage Current (V <sub>DS</sub> = 0)	V <sub>GS</sub> = ±20V			±100	nA

ON (1)

Symbol	Parameter	Test Conditions	Min.	Typ.	Max.	Unit
V <sub>GS(th)</sub>	Gate Threshold Voltage	V <sub>DS</sub> = V <sub>GS</sub> , I <sub>D</sub> = 250μA	2			V
R <sub>DS(on)</sub>	Static Drain-source On Resistance	V <sub>GS</sub> = 10V, I <sub>D</sub> = 7 A		0.10	0.12	Ω
I <sub>D(on)</sub>	On State Drain Current	V <sub>DS</sub> > I <sub>D(on)</sub> × R <sub>DS(on)max</sub> , V <sub>GS</sub> = 10V	14			A

DYNAMIC

Symbol	Parameter	Test Conditions	Min.	Typ.	Max.	Unit
g <sub>fs</sub> (1)	Forward Transconductance	V <sub>DS</sub> > I <sub>D(on)</sub> × R <sub>DS(on)max</sub> , I <sub>D</sub> = 7 A		7		S
C <sub>iss</sub>	Input Capacitance	V <sub>DS</sub> = 25V, f = 1 MHz, V <sub>GS</sub> = 0		361		pF
C <sub>oss</sub>	Output Capacitance			54		pF
C <sub>rss</sub>	Reverse Transfer Capacitance			21		pF

**ELECTRICAL CHARACTERISTICS (CONTINUED)**

**SWITCHING ON**

Symbol	Parameter	Test Conditions	Min.	Typ.	Max.	Unit
$t_{d(on)}$	Turn-on Delay Time	$V_{DD} = 30V, I_D = 7 A$ $R_G = 4.7\Omega, V_{GS} = 10V$ (see test circuit, Figure 3)		12.5		ns
$t_r$	Rise Time			32		ns
$Q_g$	Total Gate Charge	$V_{DD} = 48 V, I_D = 14 A,$ $V_{GS} = 10V$		11.2	15	nC
$Q_{gs}$	Gate-Source Charge			3.7		nC
$Q_{gd}$	Gate-Drain Charge			3.2		nC

**SWITCHING OFF**

Symbol	Parameter	Test Conditions	Min.	Typ.	Max.	Unit
$t_{d(off)}$	Turn-off-Delay Time	$V_{DD} = 30 V, I_D = 7 A,$ $R_G = 4.7\Omega, V_{GS} = 10V$ (see test circuit, Figure 3)		30		ns
$t_f$	Fall Time			9.5		ns

**SOURCE DRAIN DIODE**

Symbol	Parameter	Test Conditions	Min.	Typ.	Max.	Unit
$I_{SD}$	Source-drain Current				14	A
$I_{SDM} (1)$	Source-drain Current (pulsed)				56	A
$V_{SD} (2)$	Forward On Voltage	$I_{SD} = 14 A, V_{GS} = 0$			1.3	V
$t_{rr}$	Reverse Recovery Time	$I_{SD} = 14 A, di/dt = 100A/\mu s,$ $V_{DD} = 30 V, T_j = 150^\circ C$ (see test circuit, Figure 5)		38		ns
$Q_{rr}$	Reverse Recovery Charge			61		nC
$I_{RRM}$	Reverse Recovery Current			3.2		A

Note: 1. Pulsed: Pulse duration = 300  $\mu s$ , duty cycle 1.5 %.  
2. Pulse width limited by safe operating area.

**Safe Operating Area**

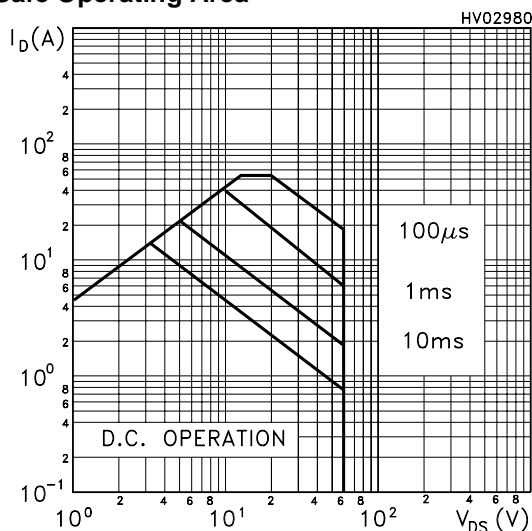

**Thermal Impedance**

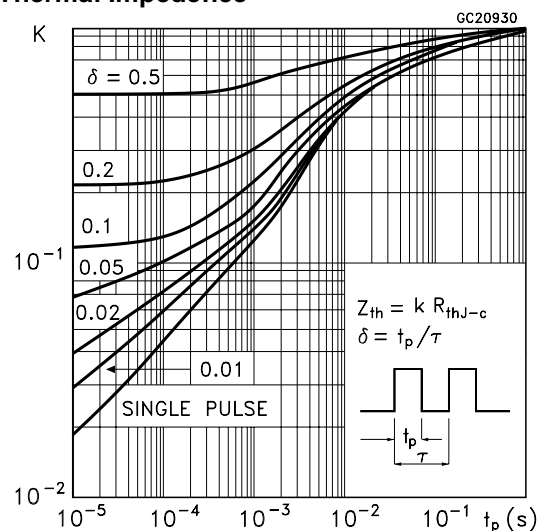

Output Characteristics

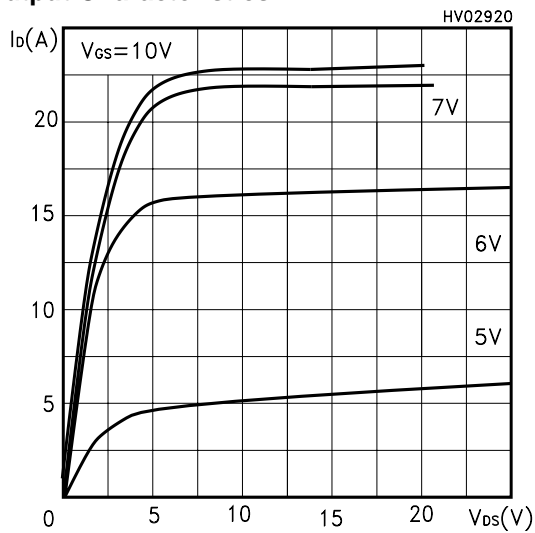

Transfer Characteristics

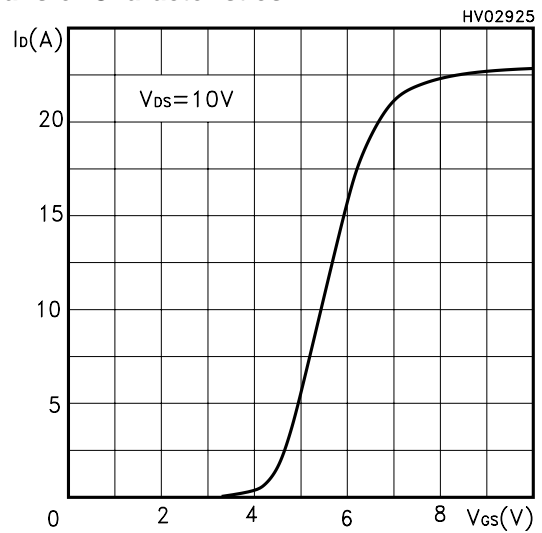

Transconductance

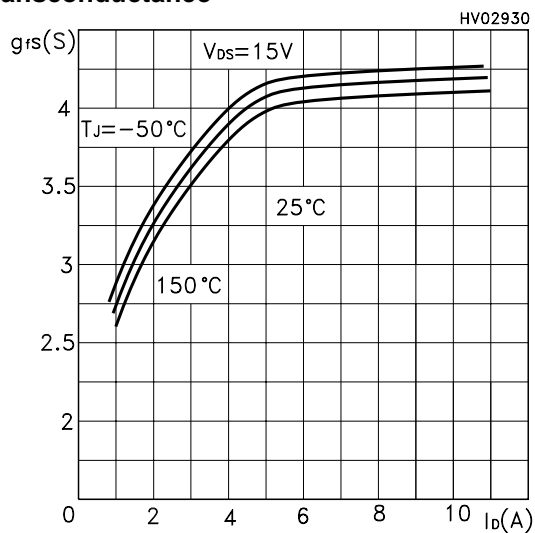

Static Drain-source On Resistance

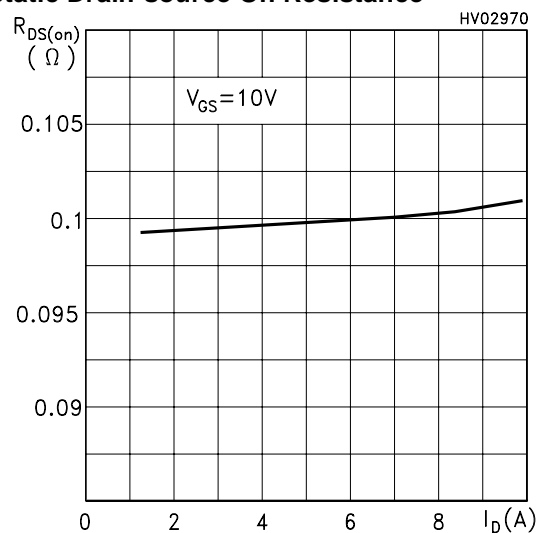

Gate Charge vs Gate-source Voltage

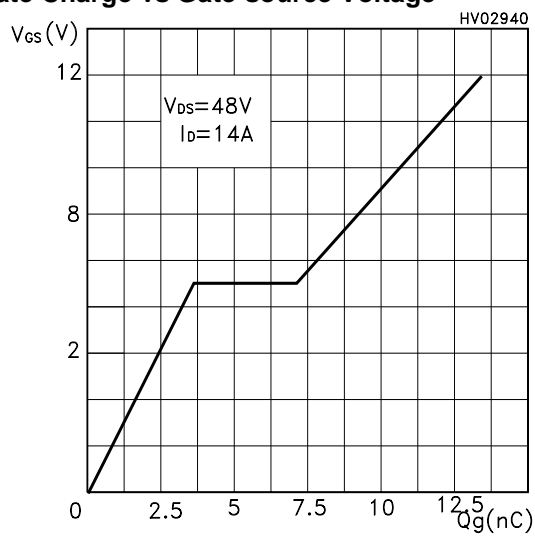

Capacitance Variations

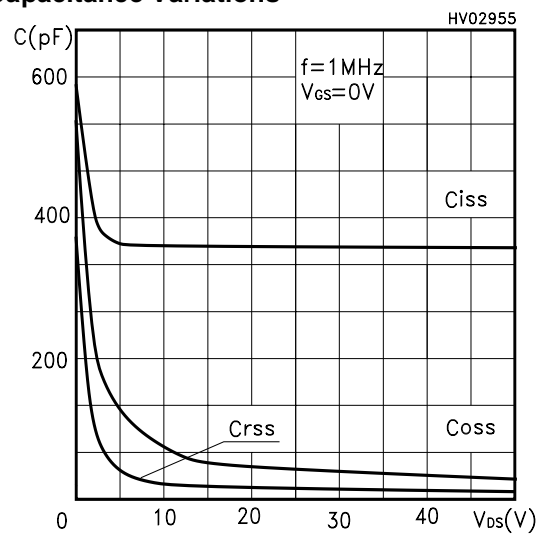

Normalized Gate Threshold Voltage vs Temp.

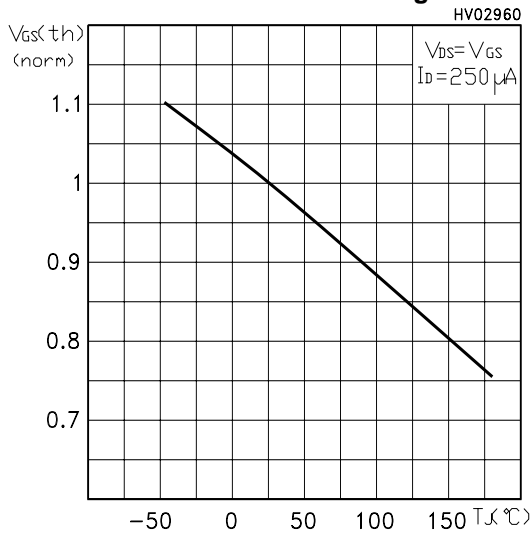

Normalized On Resistance vs Temperature

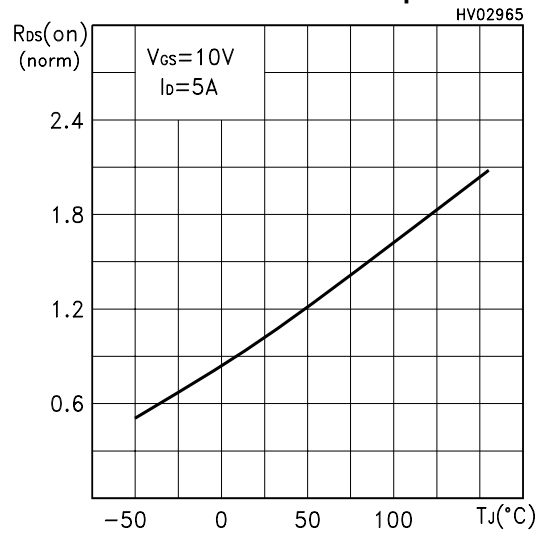

Source-drain Diode Forward Characteristics

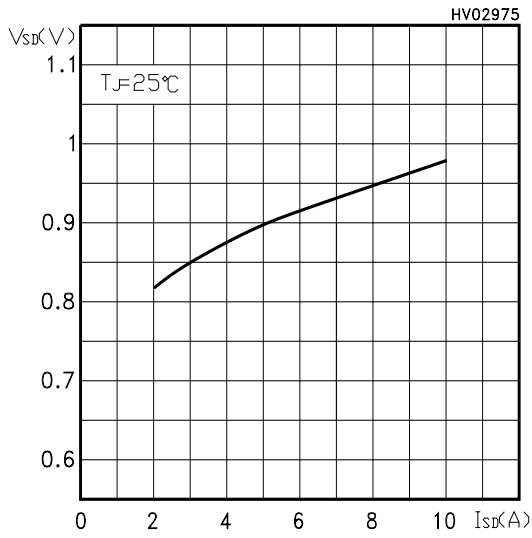

Fig. 1: Unclamped Inductive Load Test Circuit



Fig. 2: Unclamped Inductive Waveform



Fig. 3: Switching Times Test Circuit For Resistive Load



Fig. 4: Gate Charge test Circuit

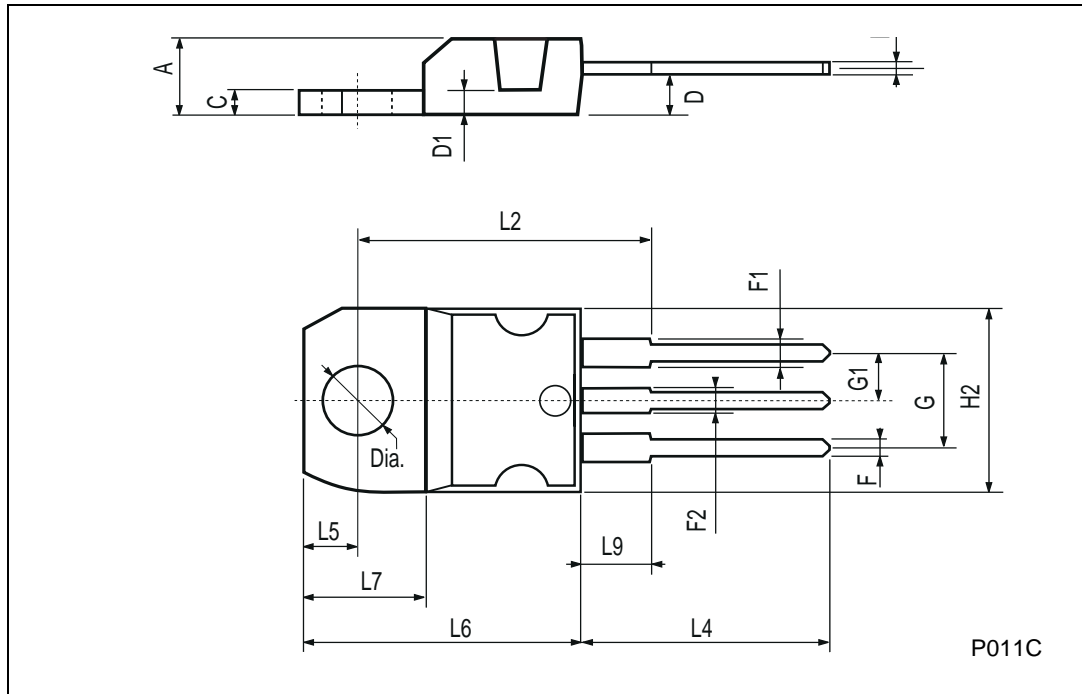

Fig. 5: Test Circuit For Inductive Load Switching And Diode Recovery Times



TO-220 MECHANICAL DATA

DIM.	mm			inch		
	MIN.	TYP.	MAX.	MIN.	TYP.	MAX.
A	4.40		4.60	0.173		0.181
C	1.23		1.32	0.048		0.051
D	2.40		2.72	0.094		0.107
D1		1.27			0.050	
E	0.49		0.70	0.019		0.027
F	0.61		0.88	0.024		0.034
F1	1.14		1.70	0.044		0.067
F2	1.14		1.70	0.044		0.067
G	4.95		5.15	0.194		0.203
G1	2.4		2.7	0.094		0.106
H2	10.0		10.40	0.393		0.409
L2		16.4			0.645	
L4	13.0		14.0	0.511		0.551
L5	2.65		2.95	0.104		0.116
L6	15.25		15.75	0.600		0.620
L7	6.2		6.6	0.244		0.260
L9	3.5		3.93	0.137		0.154
DIA.	3.75		3.85	0.147		0.151



Information furnished is believed to be accurate and reliable. However, STMicroelectronics assumes no responsibility for the consequences of use of such information nor for any infringement of patents or other rights of third parties which may result from its use. No license is granted by implication or otherwise under any patent or patent rights of STMicroelectronics. Specification mentioned in this publication are subject to change without notice. This publication supersedes and replaces all information previously supplied. STMicroelectronics products are not authorized for use as critical components in life support devices or systems without express written approval of STMicroelectronics.

The ST logo is a trademark of STMicroelectronics

© 2000 STMicroelectronics – Printed in Italy – All Rights Reserved

STMicroelectronics GROUP OF COMPANIES

Australia - Brazil - China - Finland - France - Germany - Hong Kong - India - Italy - Japan - Malaysia - Malta - Morocco -  
Singapore - Spain - Sweden - Switzerland - United Kingdom - U.S.A.

<http://www.st.com>