

TOSHIBA GaAs LINEAR INTEGRATED CIRCUIT GaAs MONOLITHIC

TG2200AF

1.9GHz BAND ANTENNA SWITCH (PHS DIGITAL CORDLESS TELEPHONE)

FEATURES

- LOW INSERTION LOSS : $L_{OSS} = 0.5\text{dB}$ (Typ.)
- HIGH ISOLATION : $ISL = 25\text{dB}$ (Typ.)
- CONTROL VOLTAGE : $0\text{V} / 3\text{V}$

PIN CONNECTION (TOP VIEW)

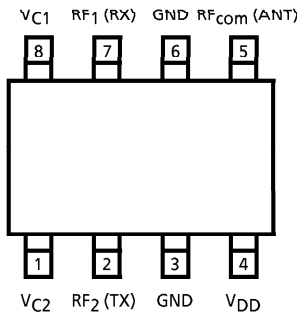

MARKING

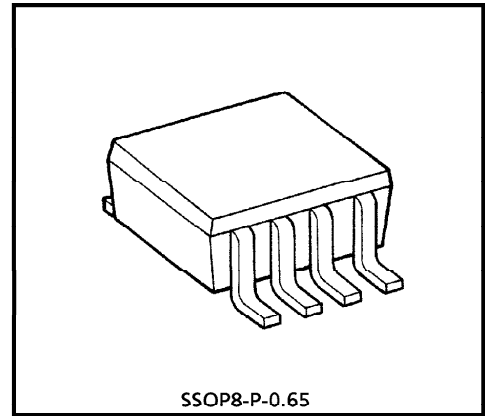
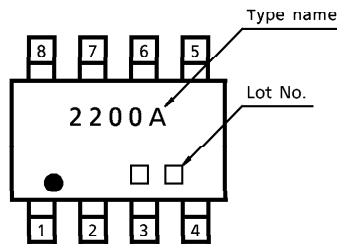

Weight : 0.02g (Typ.)

MAXIMUM RATINGS (Ta = 25°C)

CHARACTERISTIC	SYMBOL	RATING	UNIT
Supply Voltage	V_{DD}	5	V
Control Voltage	V_{C1}	5	V
	V_{C2}	5	V
Input Power	P_i	1	W
Operating Temperature Range	T_{opr}	-40~85	°C
Storage Temperature Range	T_{stg}	-55~125	°C

961001EBC1

- TOSHIBA is continually working to improve the quality and the reliability of its products. Nevertheless, semiconductor devices in general can malfunction or fail due to their inherent electrical sensitivity and vulnerability to physical stress. It is the responsibility of the buyer, when utilizing TOSHIBA products, to observe standards of safety, and to avoid situations in which a malfunction or failure of a TOSHIBA product could cause loss of human life, bodily injury or damage to property. In developing your designs, please ensure that TOSHIBA products are used within specified operating ranges as set forth in the most recent products specifications. Also, please keep in mind the precautions and conditions set forth in the TOSHIBA Semiconductor Reliability Handbook.
- Gallium arsenide (GaAs) is a substance used in the products described in this document. GaAs dust and fumes are toxic. Do not break, cut or pulverize the product, or use chemicals to dissolve them. When disposing of the products, follow the appropriate regulations. Do not dispose of the products with other industrial waste or with domestic garbage.
- The products described in this document are subject to foreign exchange and foreign trade control laws.
- The information contained herein is presented only as a guide for the applications of our products. No responsibility is assumed by TOSHIBA CORPORATION for any infringements of intellectual property or other rights of the third parties which may result from its use. No license is granted by implication or otherwise under any intellectual property or other rights of TOSHIBA CORPORATION or others.
- The information contained herein is subject to change without notice.

ELECTRICAL CHARACTERISTICS ($V_{DD} = 3V$, $T_a = 25^\circ C$, $Z_G = Z_I = 50\Omega$)

CHARACTERISTIC	SYMBOL	TEST CIRCUIT	TEST CONDITION	MIN.	TYP.	MAX.	UNIT
Frequency Range	f_{range}	—	—	1895	—	1918	MHz
Insertion Loss	LOSS (1)	1	$V_{C1} = 3V$, $V_{C2} = 0V$, $P_i = 22dBmW$	—	0.5	1.0	dB
	LOSS (2)	1	$V_{C1} = 0V$, $V_{C2} = 3V$, $P_i = 0dBmW$	—	0.5	1.0	dB
Isolation	ISL (1)	1	$V_{C1} = 3V$, $V_{C2} = 0V$, $P_i = 22dBmW$	20	25	—	dB
	ISL (2)	1	$V_{C1} = 0V$, $V_{C2} = 3V$, $P_i = 0dBmW$	20	25	—	dB
Switching Time	t_{sw}	—	$V_{C1} = 3V$, $V_{C2} = 0V$ or $V_{C1} = 0V$, $V_{C2} = 3V$	—	0.01	—	μs
Supply Current	I_{DD}			—	—	0.1	mA
Control Current	I_{C1}			—	—	0.1	mA
	I_{C2}			—	—	0.1	mA
Output Power at 1dB Gain Compression	P_{o1dB}	1	$V_{C1} = 3V$, $V_{C2} = 0V$	—	24	—	dBm W
Adjacent Channel Leakage Power Ratio	P_{adj}	1	$V_{C1} = 3V$, $V_{C2} = 0V$, $P_i = 22dBmW$ (Note), $\Delta f = 600kHz$	—	—	-60	dB

(Note) Input signal is modulated to $\pi / 4QPSK$ ($\alpha = 0.5$). Bit rate is 384kbps.

TRUTH TABLE

CONTROL VOLTAGE		SWITCH CONDITION	
V_{C1}	V_{C2}	RF_{com} (ANT)- RF_1 (RX)	RF_{com} (ANT)- RF_2 (TX)
3V	0V	OFF	ON
0V	3V	ON	OFF

EQUIVALENT CIRCUIT

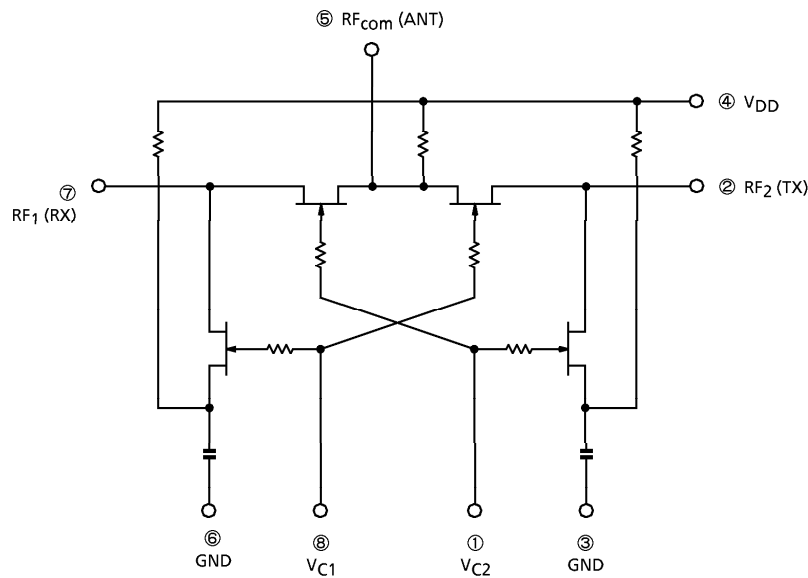

TEST CIRCUIT 1

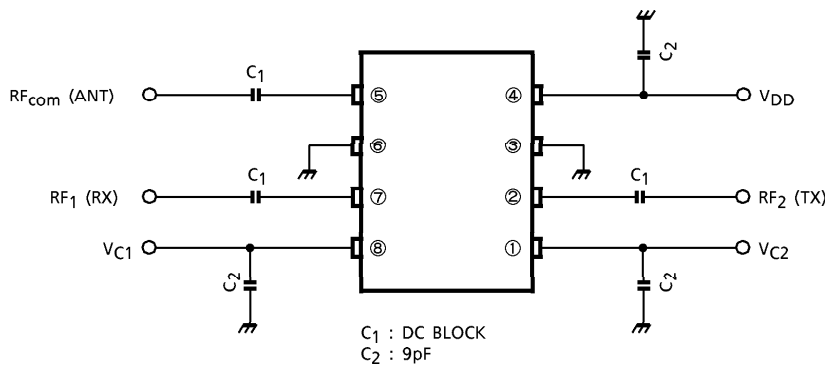

RF TEST CONDITION ($V_{DD} = 3V$, $f = 1.907GHz$, $T_a = 25^{\circ}C$, $Z_g = Z_l = 50\Omega$)

	RF _{com} (ANT)	RF ₁ (RX)	RF ₂ (TX)	INPUT POWER	V _{C1}	V _{C2}
LOSS (1)	P _O	50Ω TERMINATION	P _i	22dBmW	3V	0V
LOSS (2)	P _i	P _O	50Ω TERMINATION	0dBmW	0V	3V
ISL (1)	50Ω TERMINATION	P _O	P _i	22dBmW	3V	0V
ISL (2)	P _i	50Ω TERMINATION	P _O	0dBmW	0V	3V
P _O 1dB	P _O	50Ω TERMINATION	P _i	—	3V	0V
Padj	P _O	50Ω TERMINATION	P _i	22dBmW	3V	0V

CAUTION

This device is electrostatic sensitivity. Please handle with caution.

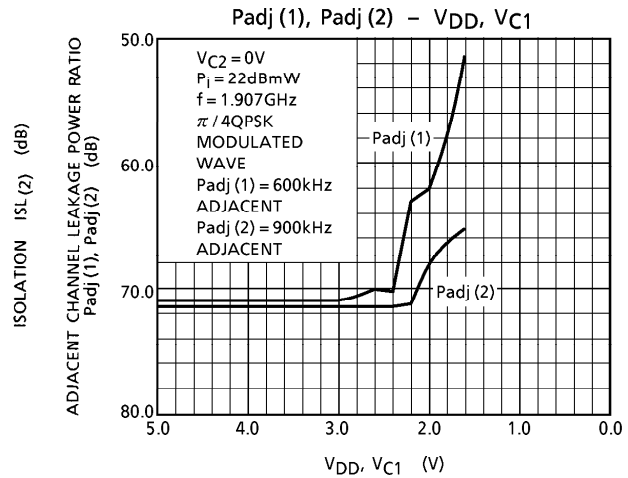
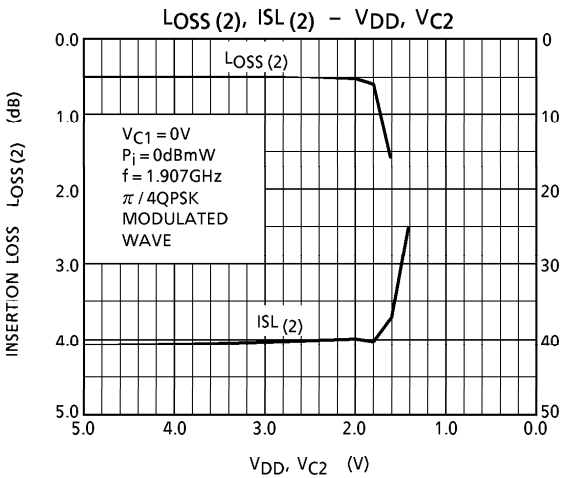
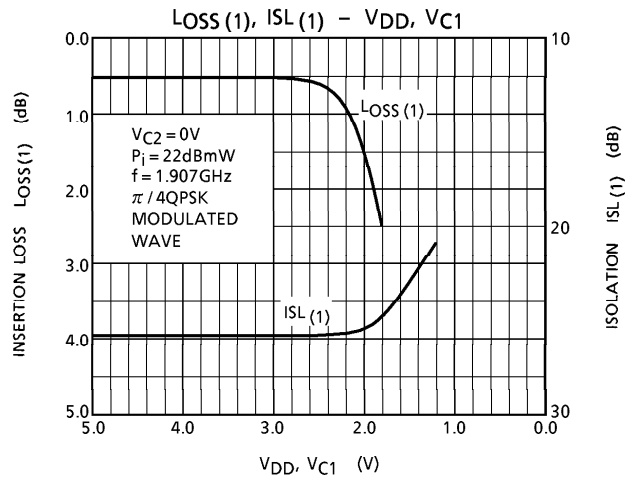
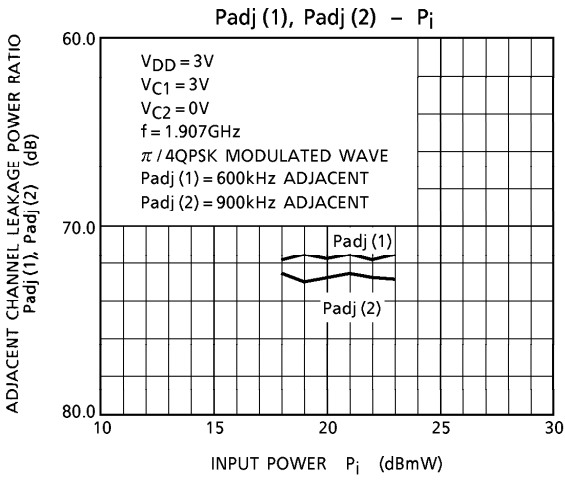
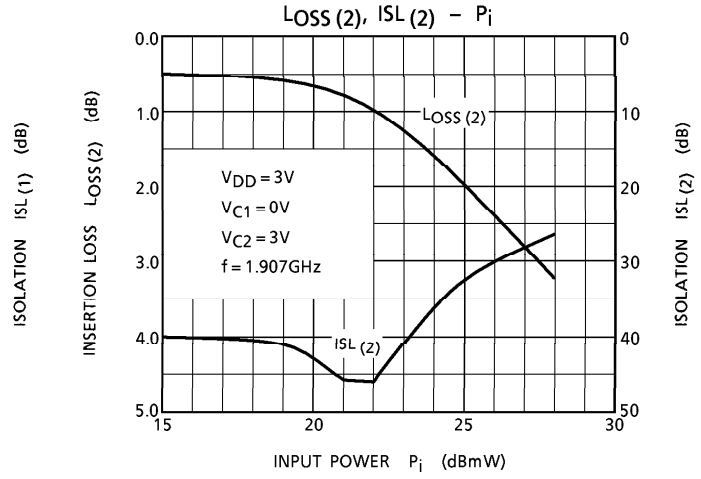
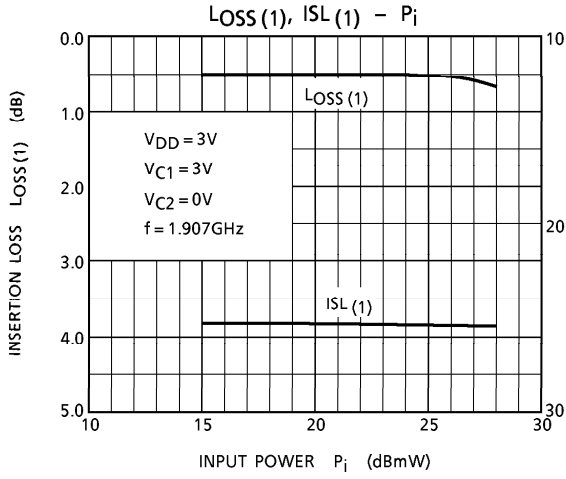

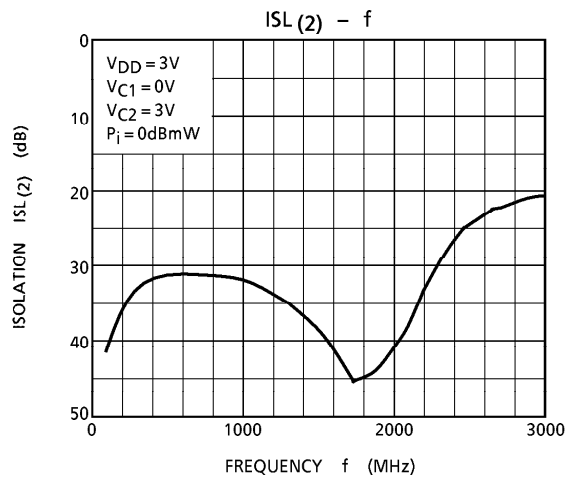
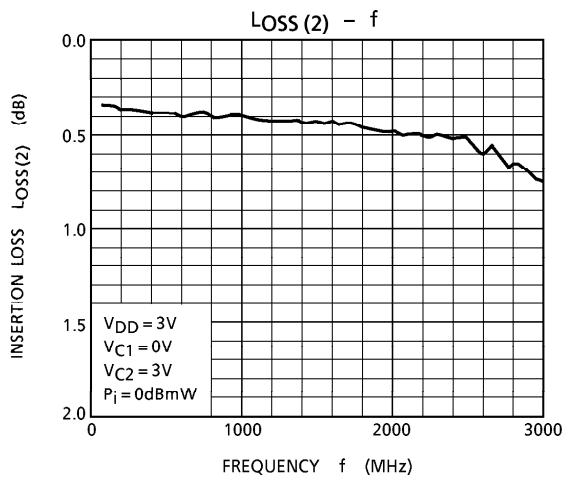
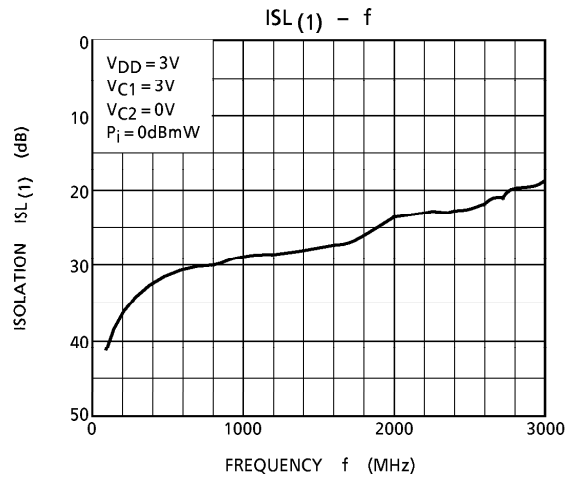
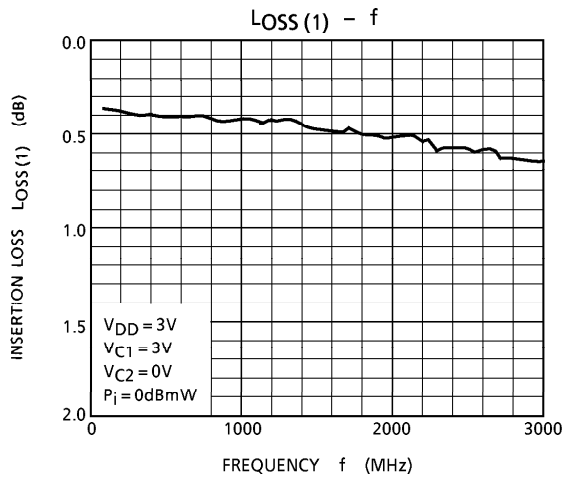

OUTLINE DRAWING
SSOP8-P-0.65

Unit : mm

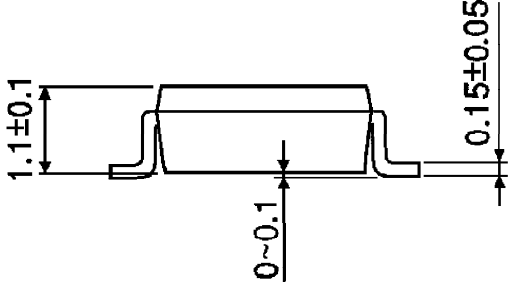
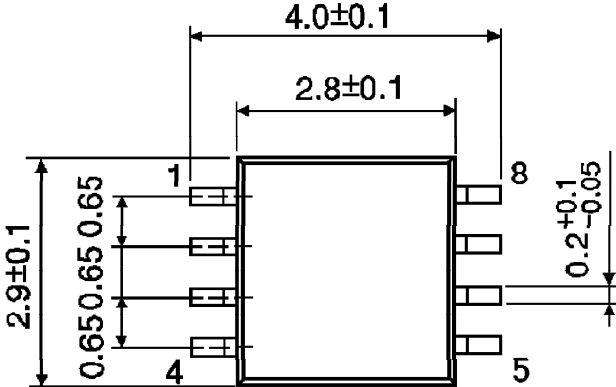

Weight : 0.02g (Typ.)