

### General Description

The AAT4610 SmartSwitch™ is a member of AnalogicTech's Application Specific Power MOSFET™ (ASPM™) product family. It is a Current Limited P-channel MOSFET power switch designed for high-side load-switching applications. This switch operates with inputs ranging from 2.7V to 5.5V, making it ideal for both 3V and 5V systems. An integrated current-limiting circuit protects the input supply against large currents which may cause the supply to fall out of regulation. The AAT4610 is also protected from thermal overload which limits power dissipation and junction temperatures. It can be used to control loads that require up to 1 A. Current limit threshold is programmed with a resistor from SET to ground. The quiescent supply current is typically a low 15µA max. In shutdown mode, the supply current decreases to less than 1µA.

The AAT4610 is available in a 5 pin SOT-23 specified over -40 to 85°C.

The AAT4600 Series is a family of adjustable and fixed SmartSwitch™ with a range of current handling capabilities. Available are single versions in adj. current limit (AAT4600, AAT4601) as well as in fixed current limit (AAT4602, AAT4625). Dual versions (AAT4620, AAT4626) are also available.

### Features

- 2.7V to 5.5V Input voltage range
- Programmable over current threshold
- Fast transient response:
  - <1µs response to short circuit
- Low quiescent current
  - 15µA typical
  - 1µA max with Switch off
- 160mΩ typical  $R_{DS(ON)}$
- Only 2.5V needed for ON/OFF Control
- Undervoltage Lockout
- Thermal shutdown
- Temp range -40 to 85°C
- 4kV ESD Rating
- UL Approved—File No. E217765
- 5 pin SOT-23 package

### Applications

- Peripheral ports
- Notebook computers
- Personal communication devices
- Hot swap supplies



UL Recognized Component

### Typical Application

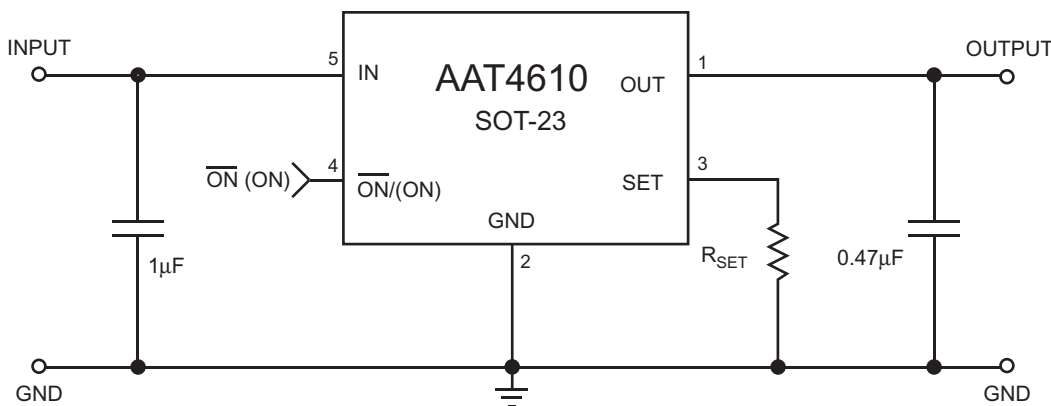

## Pin Configuration

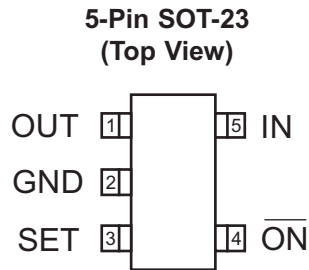

## Pin Descriptions

Pin #	Symbol	Function
1	OUT	P-channel MOSFET drain. Connect 0.47 $\mu$ F capacitor from OUT to GND.
2	GND	Ground connection
3	SET	Current-Limit Set Input. A resistor from SET to ground sets the current limit for the switch.
4	$\overline{\text{ON}}$	Enable Input. Two versions are available, active-high and active-low. See ordering information for details.
5	IN	P-channel MOSFET source. Connect 1 $\mu$ F capacitor from IN to GND.

### Absolute Maximum Ratings ( $T_A=25^\circ\text{C}$ unless otherwise noted)

Symbol	Description	Value	Units
$V_{IN}$	IN to GND	-0.3 to 6	V
$V_{ON}$	ON(ON) to GND	-0.3 to $V_{IN}+0.3$	V
$V_{SET}, V_{OUT}$	SET, OUT to GND	-0.3 to $V_{IN}+0.3$	V
$I_{MAX}$	Maximum Continuous Switch Current	2	A
$T_J$	Operating Junction Temperature Range	-40 to 150	$^\circ\text{C}$
$T_{LEAD}$	Maximum Soldering Temperature (at Leads)	300	$^\circ\text{C}$
$V_{ESD}$	ESD Rating <sup>1</sup> - HBM	4000	V

Note: Stresses above those listed in Absolute Maximum Ratings may cause permanent damage to the device. Functional operation at conditions other than the operating conditions specified is not implied. Only one Absolute Maximum rating should be applied at any one time.

Note 1: Human body model is a 100pF capacitor discharged through a 1.5k $\Omega$  resistor into each pin.

### Thermal Characteristics

Symbol	Description	Value	Units
$\theta_{JA}$	Thermal Resistance <sup>2</sup>	150	$^\circ\text{C}/\text{W}$
$P_D$	Power Dissipation <sup>2</sup>	667	mW

Note 2: Mounted on a demo board.

### Electrical Characteristics ( $V_{IN} = 5\text{V}$ , $T_A = -40$ to $85^\circ\text{C}$ unless otherwise noted. Typical values are at $T_A=25^\circ\text{C}$ )

Symbol	Description	Conditions	Min	Typ	Max	Units
$V_{IN}$	Operation Voltage		2.7		5.5	V
$I_Q$	Quiescent Current	$V_{IN} = 5\text{V}$ , ON ( $\overline{\text{ON}}$ ) = active, $I_{OUT} = 0$		15	30	$\mu\text{A}$
$I_{Q(OFF)}$	Off Supply Current	ON ( $\overline{\text{ON}}$ ) = inactive, $V_{IN} = 5.5\text{V}$			1	$\mu\text{A}$
$I_{SD(OFF)}$	Off Switch Current	ON ( $\overline{\text{ON}}$ ) = inactive, $V_{IN} = 5.5\text{V}$ , $V_{OUT} = 0$		.03	15	$\mu\text{A}$
$V_{UVLO}$	Undervoltage Lockout	Rising edge, 1% hysteresis,	2.0	2.3	2.7	V
$R_{DS(ON)}$	On-Resistance	$V_{IN}=5.0\text{V}$		160	180	m $\Omega$
		$V_{IN}=4.5\text{V}$		165		m $\Omega$
		$V_{IN}=3.0\text{V}$		195	230	m $\Omega$
$I_{LIM}$	Current Limit	$R_{SET} = 6.8\text{k}\Omega$	.75	1	1.25	A
$I_{LIM(MIN)}$	Minimum Current Limit			150		mA
$V_{ON(L)}$	ON ( $\overline{\text{ON}}$ ) Input Low Voltage				0.8	V
$V_{ON(H)}$	ON ( $\overline{\text{ON}}$ ) Input High Voltage	$V_{IN}=2.7\text{V}$ to $3.6\text{V}$	2.0			V
		$V_{IN}=4.5\text{V}$ to $5.5\text{V}$	2.4			V
$I_{ON(SINK)}$	ON ( $\overline{\text{ON}}$ ) Input leakage	$V_{ON} = 5.5\text{V}$		0.01	1	$\mu\text{A}$
$T_{RESP}$	Current Limit Response Time	$V_{IN}=5\text{V}$		0.8		$\mu\text{s}$
$T_{OFF}$	Turn-Off Time	$V_{IN}=5\text{V}$ , $R_L=10\Omega$		0.4	2	$\mu\text{s}$
$T_{ON}$	Turn-On Time	$V_{IN}=5\text{V}$ , $R_L=10\Omega$		40	200	$\mu\text{s}$

### Typical Characteristics

(Unless otherwise noted,  $V_{IN} = 5V$ ,  $T_A = 25^\circ C$ )

**Quiescent Current vs. Temperature**

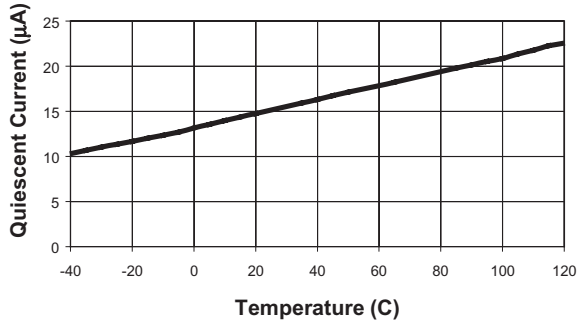

**Quiescent Current**

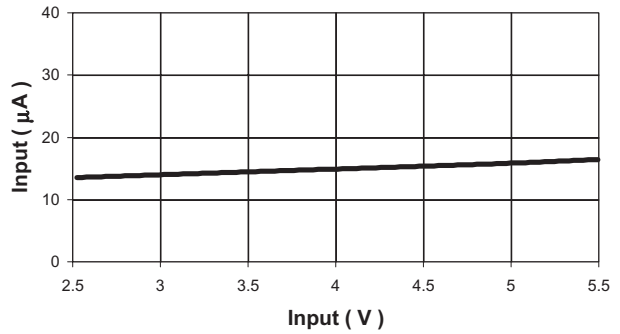

**Output Current vs  $V_{OUT}$**

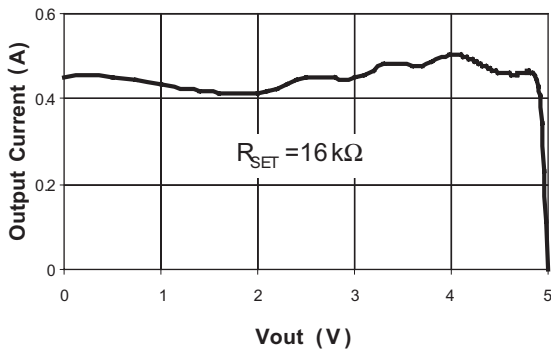

**$R_{DS(ON)}$  vs. Temperature**

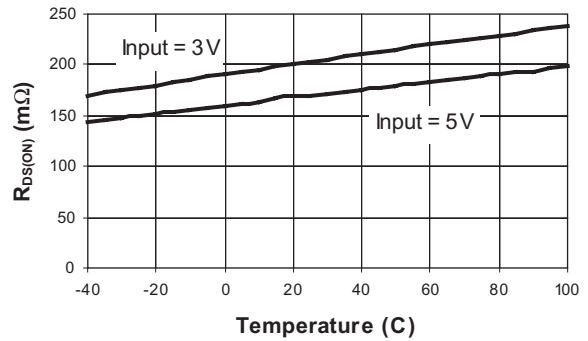

**Off-Supply Current vs. Temperature**

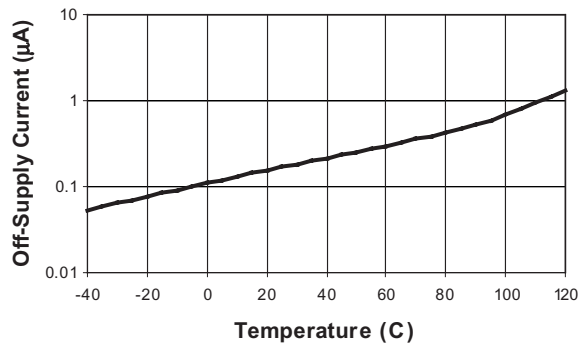

**Off-Switch Current vs. Temperature**

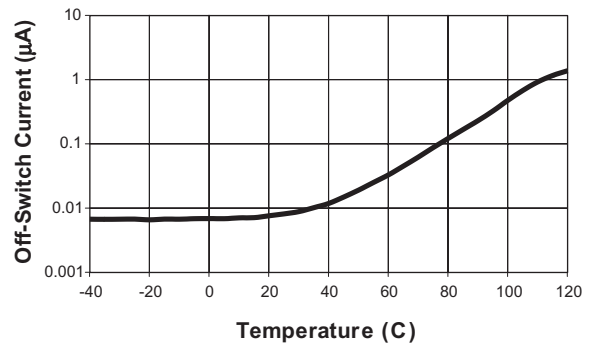

(Unless otherwise noted,  $V_{IN} = 5V$ ,  $T_A = 25^\circ C$ )

**Turn-ON vs. Temperature**

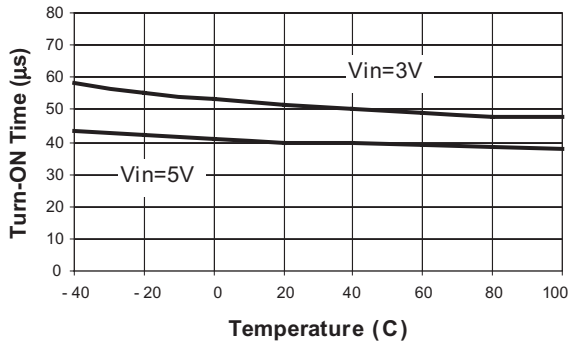

**Turn-OFF vs. Temperature**

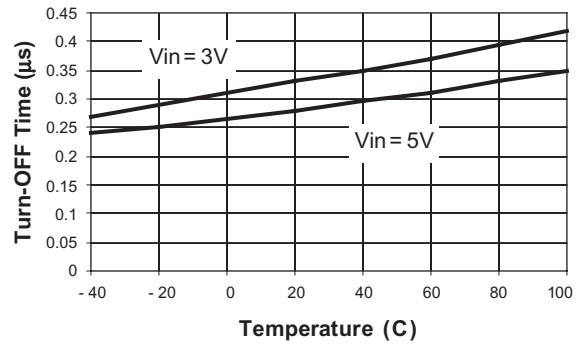

**Turn-On**  
 $R_L = 10\Omega$ ,  $C_L = 0.47\mu F$

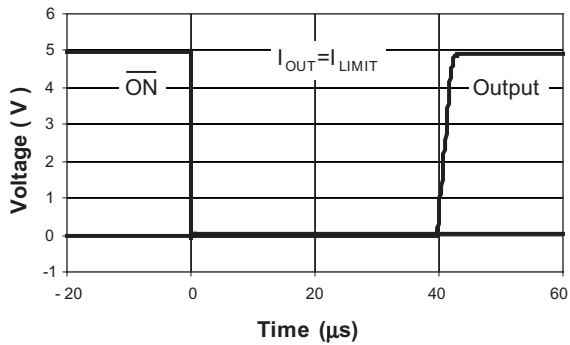

**Turn-Off**  
 $R_L = 10\Omega$

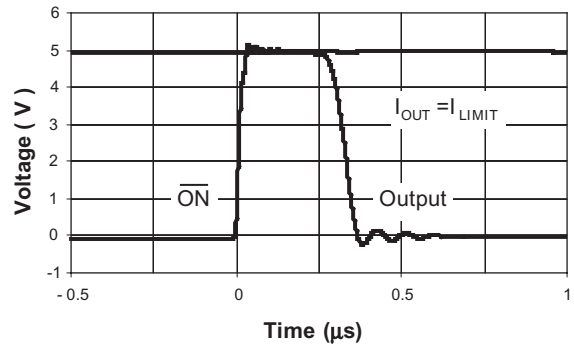

**Short Circuit through 0.3Ω**

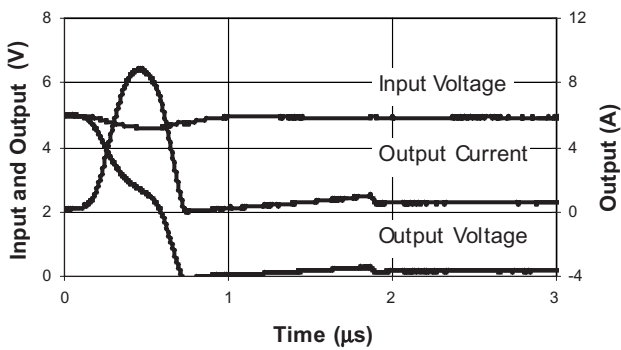

**Short Circuit through 0.6Ω**

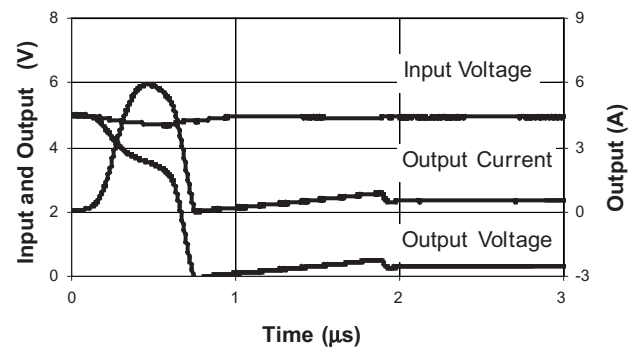



(Unless otherwise noted,  $V_{IN} = 5V$ ,  $T_A = 25^\circ C$ )

**$R_{SET}$  vs  $I_{LIM}$**

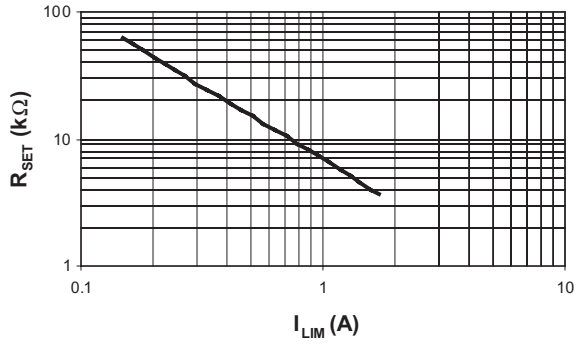

**$R_{SET}$  coefficient vs  $I_{LIM}$**

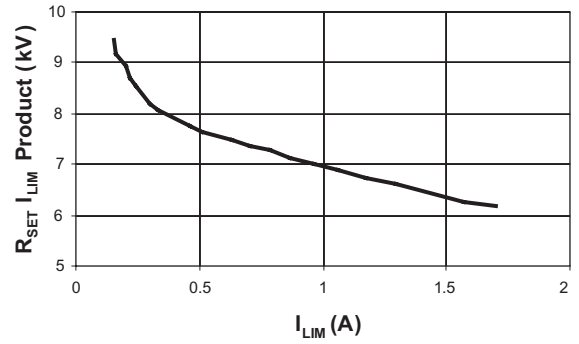

**Current Limit v. Temperature**

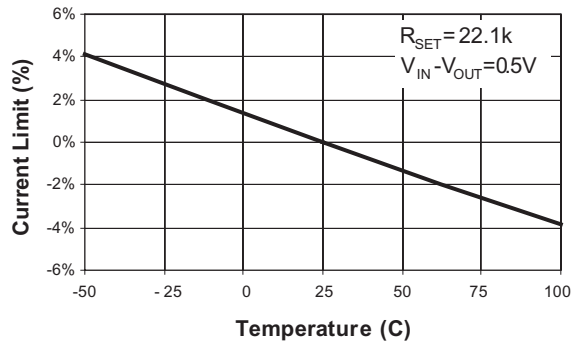

**Functional Block Diagram**

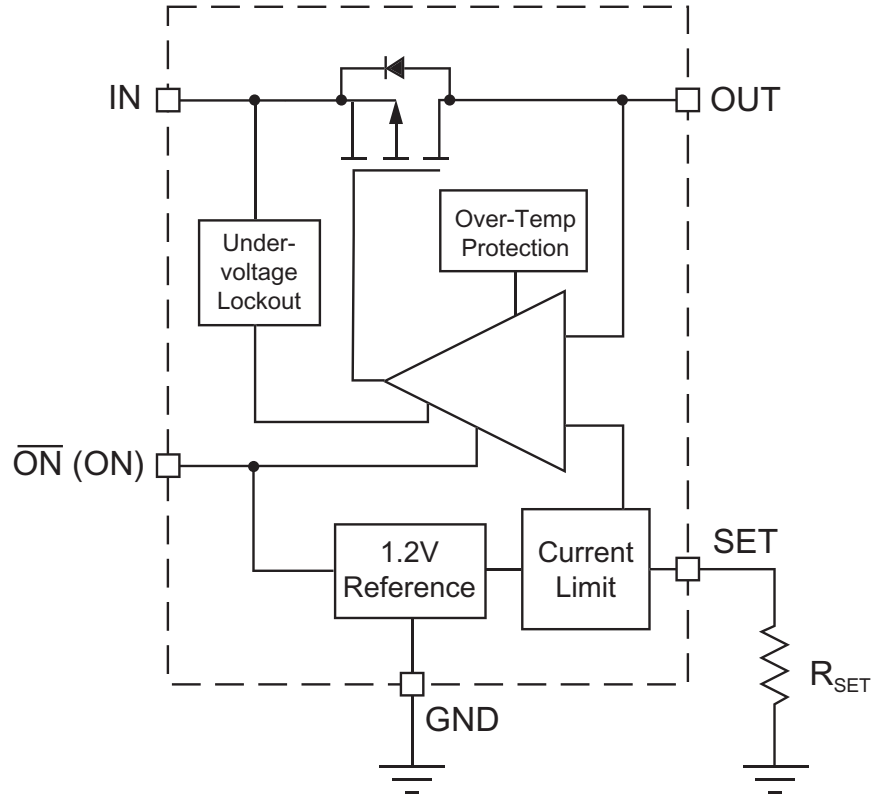

## Applications Information

### Setting Current Limit

In most applications, the variation in  $I_{LIM}$  must be taken into account when determining  $R_{SET}$ . The  $I_{LIM}$  variation is due to processing variations from part to part, as well as variations in the voltages at IN (pin 5) and OUT (pin 3), plus the operating temperature. See charts "Current Limit vs. Temperature", and "Output Current vs.  $V_{OUT}$ ". Together these three factors add up to a  $\pm 25\%$  tolerance (see  $I_{LIM}$  specification in Electrical Characteristics section). In the figure below, a cold device with a statistically higher current limit, and a hot device with a statistically lower current limit, both with  $R_{SET}$  equal to  $10.5k\Omega$  are shown. While the chart, " $R_{SET}$  vs.  $I_{LIM}$ " indicates an  $I_{LIM}$  of  $0.7A$  with an  $R_{SET}$  of  $10.5k\Omega$ , this figure shows that the actual current limit will be at least  $0.525A$ , and no greater than  $0.880A$ .

Current Limit Using  $10.5k\Omega$

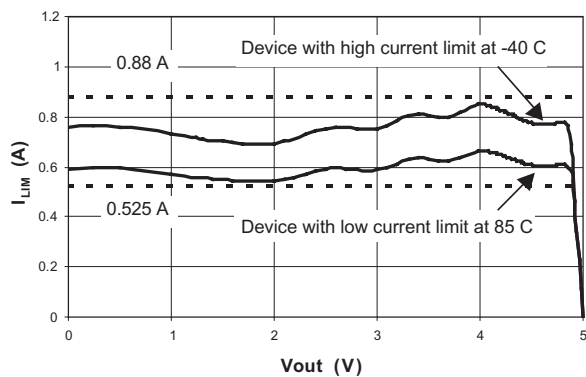

To determine  $R_{SET}$ , start with the maximum current drawn by the load, and multiply it by 1.33. (typical  $I_{LIM} = \text{minimum } I_{LIM} / 0.75$ ) This is the typical current limit value. Next, refer to " $R_{SET}$  vs.  $I_{LIM}$ " and find the  $R_{SET}$  that corresponds to the typical current limit value. Choose the largest resistor available

that is less than or equal to it. For greater precision, the value of  $R_{SET}$  may also be calculated using the  $I_{LIM} R_{SET}$  product found in the chart " $R_{SET}$  coefficient vs.  $I_{LIM}$ ". The maximum current is derived by multiplying the typical current for the chosen  $R_{SET}$  in the chart by 1.25. A few standard resistor values are listed in the table "Current Limit  $R_{SET}$  Values".

### Current Limit $R_{SET}$ Values

$R_{SET}$ (k $\Omega$ )	Current Limit typ (mA)	Device will not current limit below: (mA)	Device always current limits below: (mA)
40.2	200	150	250
30.9	250	188	313
24.9	300	225	375
22.1	350	263	438
19.6	400	300	500
17.8	450	338	563
16.2	500	375	625
14.7	550	413	688
13.0	600	450	750
10.5	700	525	875
8.87	800	600	1000
7.50	900	675	1125
6.81	1000	750	1250
6.04	1100	825	1375
5.49	1200	900	1500
4.99	1300	975	1625
4.64	1400	1050	1750

Example: A USB port requires  $0.5A$ .  $0.5A$  multiplied by 1.33 is  $0.665A$ . From the chart named " $R_{SET}$  vs.  $I_{LIM}$ ",  $R_{SET}$  should be less than  $11k\Omega$ .  $10.5k\Omega$  is a standard value that is a little less than  $11k\Omega$  but very close. The chart reads approximately  $0.700A$  as a typical  $I_{LIM}$  value for  $10.5k\Omega$ . Multiplying  $0.700A$  by  $0.75$  and  $1.25$  shows that the AAT4610 will limit the load current to greater than  $0.525A$  but less than  $0.875A$ .



### Overload Operation

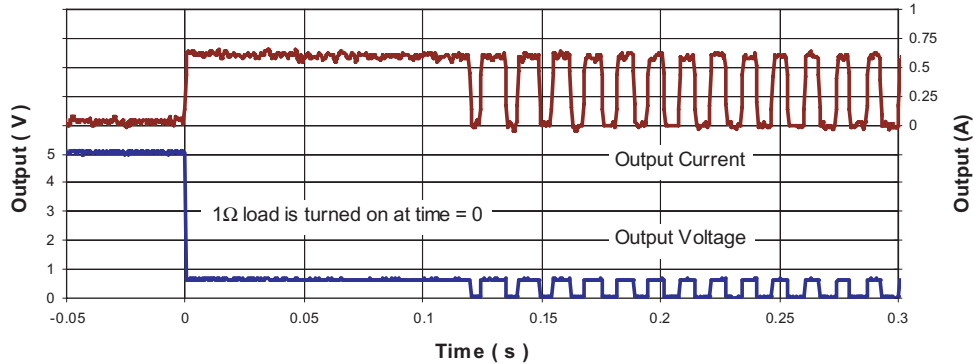

### Operation in Current Limit

When a heavy load is applied to the output of the AAT4610, the load current is limited to the value of  $I_{LIM}$  determined by  $R_{SET}$ . See the figure "Overload Operation". Since the load is demanding more current than  $I_{LIM}$ , the voltage at the output drops. This causes the AAT4610 to dissipate a larger than normal quantity of power, and its die temperature to increase. When the die temperature exceeds an over temperature limit, the AAT4610 will shut down until it has cooled sufficiently, at which point it will startup again. The AAT4610 will continue to cycle on and off until the load is removed, power is removed, or until a logic high level is applied to ON (pin 4).

### Enable Input

In many systems, power planes are controlled by integrated circuits which run at lower voltages than the power plane itself. The enable input ON (pin 4) of the AAT4610 has low and high threshold voltages that accommodate this condition. The threshold voltages are compatible with 5 volt TTL, and 2.5 volt to 5 volt CMOS.

### Reverse Voltage

The AAT4610 is designed to control current flowing from IN to OUT. If a voltage is applied to OUT which is greater than the voltage on IN, large currents may flow. This could cause damage to the AAT4610.

### Ordering Information

Package	Enable	Marking	Part Number	
			Bulk	Tape and Reel
SOT-23-5	$\overline{\text{ON}}$ (active low)		N/A	AAT4610IGV-T1
SOT-23-5	ON (active high)		N/A	AAT4610IGV-1-T1

### Package Information

#### SOT-23-5

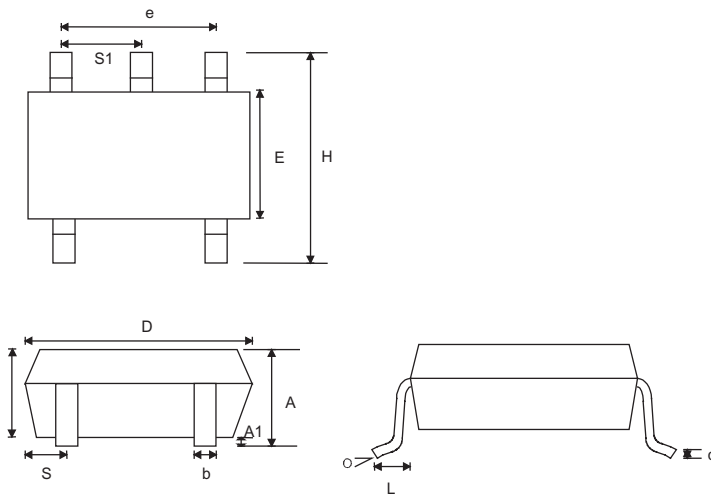

Dim	Millimeters		Inches	
	Min	Max	Min	Max
A	0.95	1.45	0.037	0.057
A1	0.05	0.15	0.002	0.006
A2	0.90	1.30	0.035	0.051
b	0.35	0.50	0.014	0.019
c	0.08	0.20	0.003	0.078
D	2.84	3.00	0.112	0.112
E	1.50	1.70	0.059	0.067
e	1.90		0.0748	
H	2.60	3.00	0.102	0.118
L	0.35	0.55	.0137	.0216
S	0.47	0.55	0.019	.0216
S1	.95		0.037	
$\Theta$	0°	10°	0°	10°