

## FEATURES

- **Guaranteed 20 ppm/°C Drift (H Package and Z Package)**
- **Guaranteed 40 ppm/°C Drift (SO-8 Package)**
- **20 $\mu$ A to 20mA Operation (1.2V)**
- Dynamic Impedance: 1 $\Omega$
- 7V, 100 $\mu$ A Reference

## APPLICATIONS

- Portable Meters
- Precision Regulators
- Calibrators

## DESCRIPTION

The LT<sup>®</sup>1034 is a micropower, precision 1.2V/2.5V reference combined with a 7V auxiliary reference. The 1.2V/2.5V reference is a trimmed, thin-film, band-gap, voltage reference with 1% initial tolerance and guaranteed 20ppm/°C temperature drift. Operating on only 20 $\mu$ A, the LT1034 offers guaranteed drift, low temperature cycling hysteresis and good long-term stability. The low dynamic impedance makes the LT1034 easy to use from unregulated supplies. The 7V reference is a subsurface zener device for less demanding applications.

The LT1034 reference can be used as a high performance upgrade of the LM385 or LT1004, where guaranteed temperature drift is desired.

LT, LTC and LT are registered trademarks of Linear Technology Corporation.

## TYPICAL APPLICATION AND BLOCK DIAGRAM

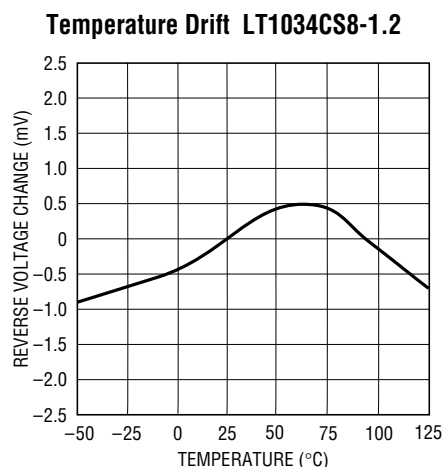
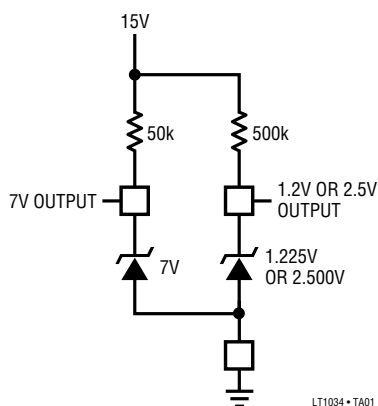

## RELATED PARTS

PART NUMBER	DESCRIPTION	COMMENTS
LT1004	Low Cost Precision Band-Gap	Micropower, SO-8, Industrial Temperature Options
LT1019	Precision Series or Shunt Band-Gap	Low Dropout, Multiple Output Options
LT1236	Precision Series or Shunt Buried Zener	Low Noise, Low Power, Multiple Output Options

# LT1034-1.2/LT1034-2.5

## ABSOLUTE MAXIMUM RATINGS

Operating Current ..... 20mA  
 Forward Current (Note 1) ..... 20mA  
 Storage Temperature Range ..... -65°C to 150°C  
 Lead Temperature (Soldering, 10 sec) ..... 300°C

Operating Temperature  
 Commercial ..... 0° to 70°C  
 Industrial ..... -40°C to 85°C  
 Military ..... -55°C to 125°C

## PACKAGE/ORDER INFORMATION

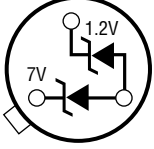
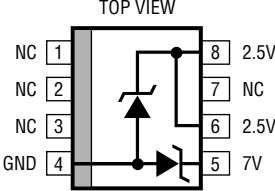
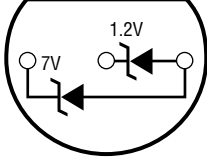
 <p>BOTTOM VIEW</p> <p>H PACKAGE 3-LEAD TO-46 METAL CAN T<sub>JMAX</sub> = 150°C, θ<sub>JA</sub> = 440°C/W, θ<sub>JC</sub> = 80°C/W</p>	ORDER PART NUMBER	 <p>TOP VIEW</p> <p>S8 PACKAGE 8-LEAD PLASTIC SO T<sub>JMAX</sub> = 175°C, θ<sub>JA</sub> = 150°C/W</p>	ORDER PART NUMBER
	LT1034BCH-1.2 LT1034BCH-2.5 LT1034BMH-1.2 LT1034BMH-2.5 LT1034CH-1.2 LT1034CH-2.5 LT1034MH-1.2 LT1034MH-2.5		LT1034CS8-1.2 LT1034CS8-2.5 LT1034IS8-1.2 LT1034IS8-2.5
 <p>BOTTOM VIEW</p> <p>Z PACKAGE 3-LEAD TO-92 PLASTIC T<sub>JMAX</sub> = 100°C, θ<sub>JA</sub> = 160°C/W</p>	ORDER PART NUMBER		PART MARKING
	LT1034BCZ-1.2 LT1034BCZ-2.5 LT1034BIZ-1.2 LT1034BIZ-2.5 LT1034CZ-1.2 LT1034CZ-2.5 LT1034IZ-1.2 LT1034IZ-2.5		3401 3402 34I01 34I02

## ELECTRICAL CHARACTERISTICS

T<sub>A</sub> = 25°C, unless otherwise specified.

PARAMETER	CONDITIONS		LT1034-1.2			LT1034-2.5			UNITS
			MIN	TYP	MAX	MIN	TYP	MAX	
Reverse Breakdown Voltage	I <sub>R</sub> = 100μA	●	1.210	1.225	1.240	2.46	2.5	2.54	V
			1.205	1.225	1.245	2.43	2.5	2.57	V
Reverse Breakdown Change with Current	Note 3 2mA ≤ I <sub>R</sub> ≤ 20mA	●		0.5	2.0		1.0	3.0	mV
		●		1.0	4.0		1.5	6.0	mV
		●		4.0	8.0		6.0	16.0	mV
		●		6.0	15.0		10.0	20.0	mV
Minimum Operating Current		●		10	20		15	30	μA
Temperature Coefficient	I <sub>R</sub> = 100μA LT1034B LT1034	●		10	20		10	20	ppm/°C
				20	40		20	40	ppm/°C
Reverse Dynamic Impedance (Note 2)	I <sub>R</sub> = 100μA	●		0.25	1.0		0.5	1.5	Ω
				0.50	2.0		1.0	2.5	Ω
Low Frequency Noise	I <sub>R</sub> = 100μA, 0.1Hz ≤ F ≤ 10Hz	●		4			6	μV <sub>p-p</sub>	
Long-Term Stability	I <sub>R</sub> = 100μA			20			20	ppm√khrs	

**ELECTRICAL CHARACTERISTICS** 7V Reference.  $T_A = 25^\circ\text{C}$ , unless otherwise specified.

PARAMETER	CONDITIONS	MIN	TYP	MAX	UNITS	
Reverse Breakdown Voltage	$I_R = 100\mu\text{A}$	●	6.80	7.0	7.3	V
			6.75	7.0	7.4	V
Reverse Breakdown Change with Current	$100\mu\text{A} \leq I_R \leq 1\text{mA}$		90	140	mV	
	$100\mu\text{A} \leq I_R \leq 1\text{mA}$	●	100	190	mV	
	$1\text{mA} \leq I_R \leq 20\text{mA}$	●	160	250	mV	
	$1\text{mA} \leq I_R \leq 20\text{mA}$	●	200	350	mV	
Temperature Coefficient	$I_R = 100\mu\text{A}$	●	40		ppm/ $^\circ\text{C}$	
Long-Term Stability	$I_R = 100\mu\text{A}$		20		ppm/ $\sqrt{\text{khrs}}$	

The ● denotes specifications which apply over the full operating temperature range.

**Note 1:** Forward biasing either diode will affect the operation of the other diode.

**Note 2:** This parameter guaranteed by “reverse breakdown change with current” test.

**Note 3:** For the LT1034-1.2:  $20\mu\text{A} \leq I_R \leq 2\text{mA}$ . For the LT1034-2.5:  $30\mu\text{A} \leq I_R \leq 2\text{mA}$ .

**TYPICAL PERFORMANCE CHARACTERISTICS**

Reverse Voltage Change 1.2V

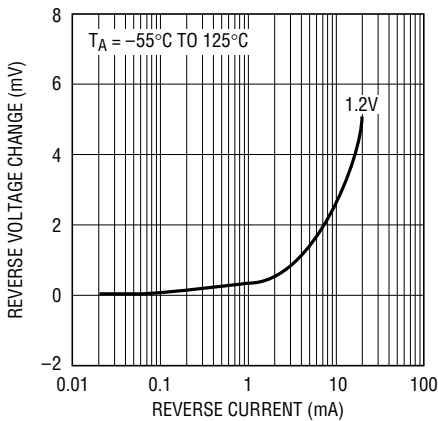

LT1034 • TPC01

Reverse Voltage Change 7V

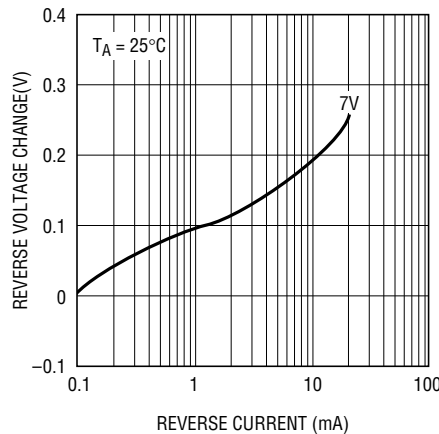

LT1034 • TPC02

0.1Hz to 10Hz Noise 1.2V

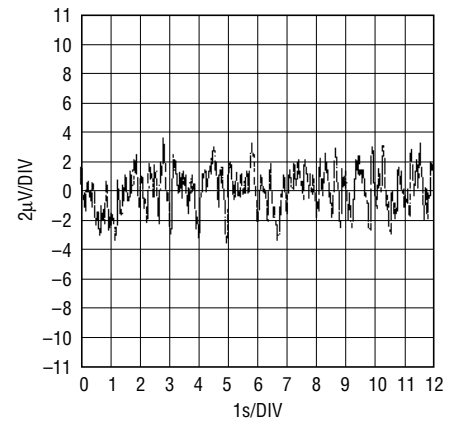

LT1034 • TPC03

Reverse Dynamic Impedance 1.2V

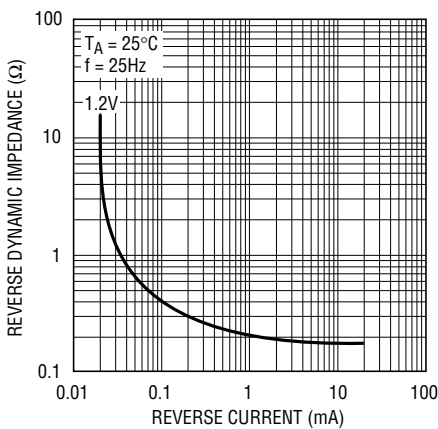

LT1034 • TPC04

Reverse Dynamic Impedance 2.5V

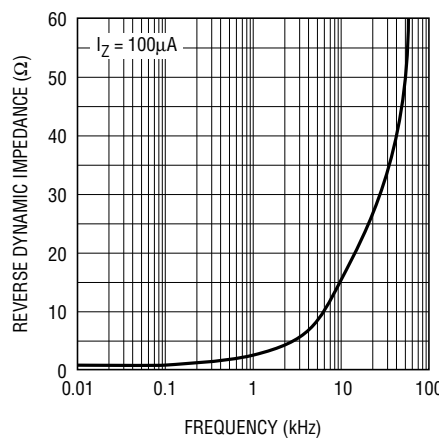

LT1034 • TPC05

Reverse Dynamic Impedance 7V

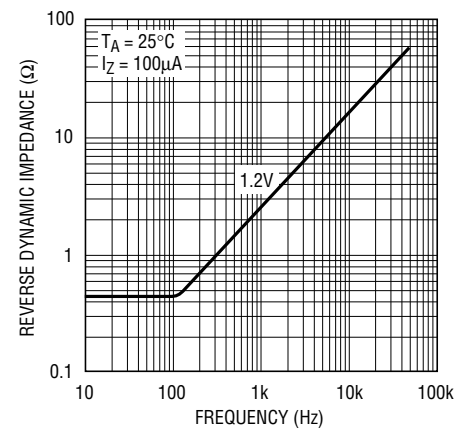

LT1034 • TPC06

# TYPICAL PERFORMANCE CHARACTERISTICS

Reverse Characteristics 1.2V

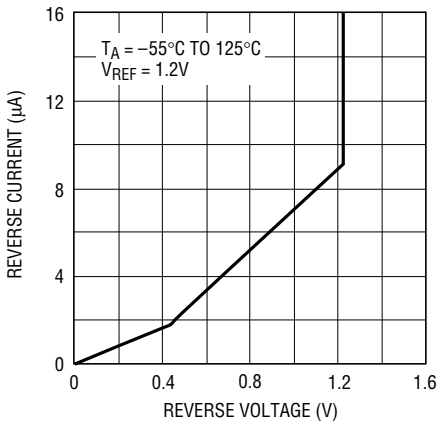

LT1034 • TPC07

Reverse Characteristics 2.5V

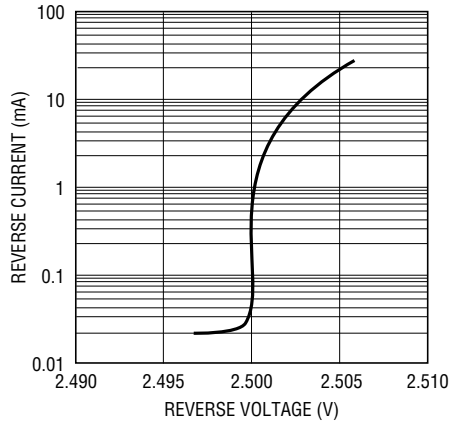

LT1034 • TPC02

Reverse Characteristics 7V

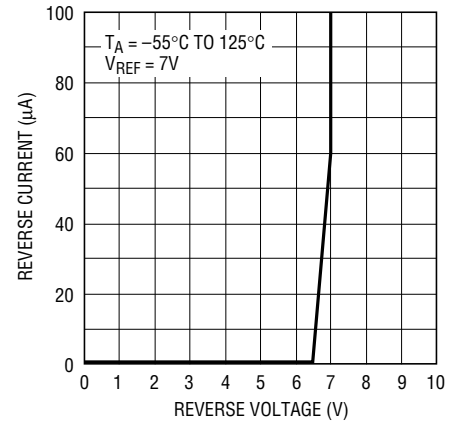

LT1034 • TPC09

Forward Characteristics

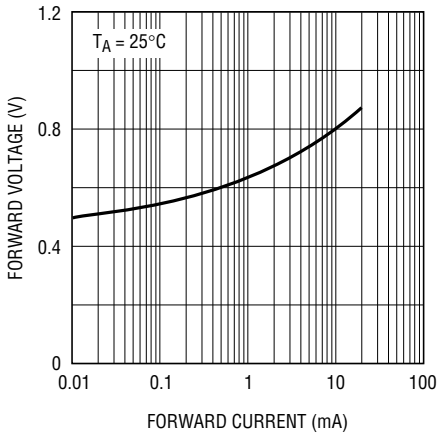

LT1034 • TPC10

Response Time

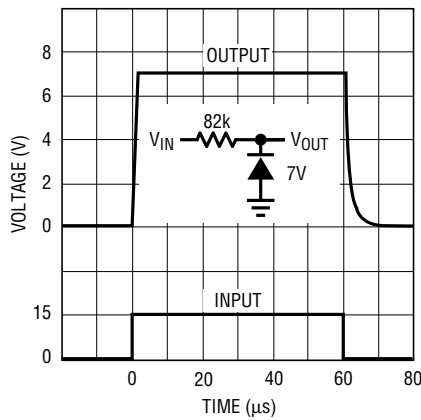

LT1180A • TPC11

Response Time

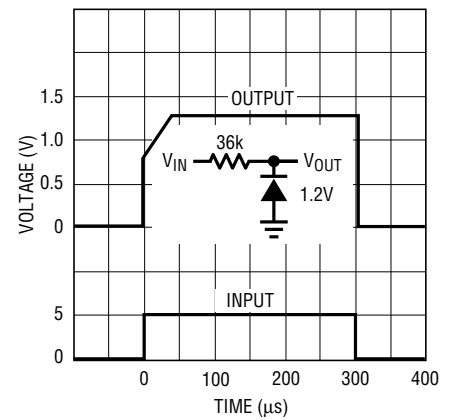

LT1180A • TPC12

## PACKAGE DESCRIPTION

Dimension in inches (millimeters) unless otherwise noted.

H Package  
Metal Can

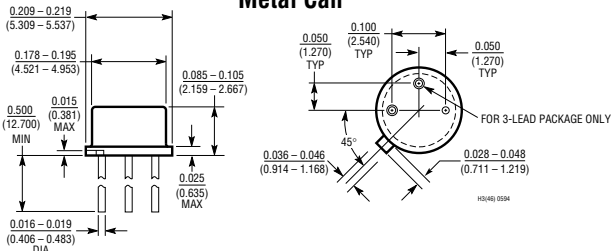

S8 Package  
8-Lead Plastic SO

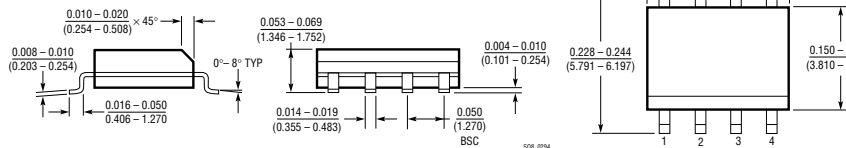

Z Package  
Plastic

