

FEATURES

- 100MHz Gain Bandwidth
- 750V/ μ s Slew Rate
- 3.6mA Maximum Supply Current per Amplifier
- 8nV/ $\sqrt{\text{Hz}}$ Input Noise Voltage
- Unity-Gain Stable
- 1.5mV Maximum Input Offset Voltage
- 4 μ A Maximum Input Bias Current
- 400nA Maximum Input Offset Current
- 40mA Minimum Output Current, $V_{OUT} = \pm 3V$
- $\pm 3.5V$ Minimum Input CMR, $V_S = \pm 5V$
- Specified at $\pm 5V$, Single 5V
- Available in MS8 and SO-8 Packages

APPLICATIONS

- Wideband Amplifiers
- Buffers
- Active Filters
- Video and RF Amplification
- Cable Drivers
- Data Acquisition Systems

DESCRIPTION

The LT[®]1813 is a low power, high speed, very high slew rate operational amplifier with excellent DC performance. The LT1813 features reduced supply current, lower input offset voltage, lower input bias current and higher DC gain than other devices with comparable bandwidth. The circuit topology is a voltage feedback amplifier with the slewing characteristics of a current feedback amplifier.

The output drives a 100 Ω load to $\pm 3.5V$ with $\pm 5V$ supplies. On a single 5V supply, the output swings from 1.1V to 3.9V with a 100 Ω load connected to 2.5V. The amplifier is stable with a 1000pF capacitive load which makes it useful in buffer and cable driver applications.

The LT1813 is manufactured on Linear Technology's advanced low voltage complementary bipolar process. For higher supply voltage single, dual and quad operational amplifiers with up to 70MHz gain bandwidth, see the LT1351 through LT1365 data sheets.

 LTC and LT are registered trademarks of Linear Technology Corporation.

TYPICAL APPLICATION

4MHz, 4th Order Butterworth Filter

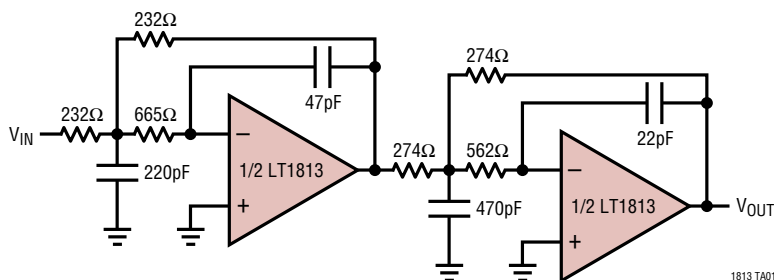

Filter Frequency Response

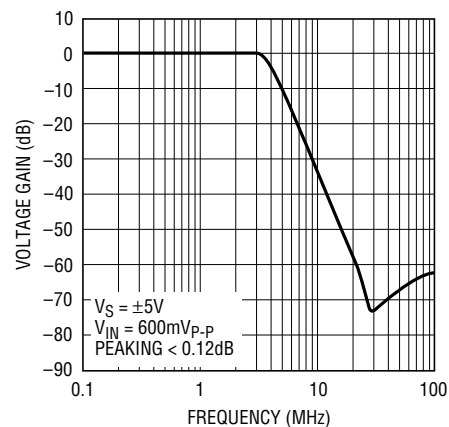

1813 TA02

ABSOLUTE MAXIMUM RATINGS (Note 1)

Total Supply Voltage (V^+ to V^-)	12.6V	Specified Temperature Range	
Differential Input Voltage (Transient Only, Note 2) ...	$\pm 3V$	(Notes 8, 9)	$-40^{\circ}C$ to $85^{\circ}C$
Input Voltage	$\pm V_S$	Maximum Junction Temperature	$150^{\circ}C$
Output Short-Circuit Duration (Note 3)	Indefinite	Storage Temperature Range	$-65^{\circ}C$ to $150^{\circ}C$
Operating Temperature Range	$-40^{\circ}C$ to $85^{\circ}C$	Lead Temperature (Soldering, 10 sec)	$300^{\circ}C$

PACKAGE/ORDER INFORMATION

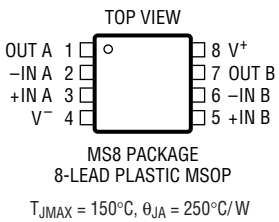
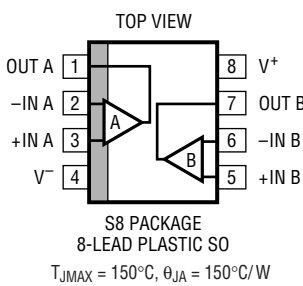
 <p>MS8 PACKAGE 8-LEAD PLASTIC MSOP $T_{JMAX} = 150^{\circ}C$, $\theta_{JA} = 250^{\circ}C/W$</p>	ORDER PART NUMBER	 <p>S8 PACKAGE 8-LEAD PLASTIC SO $T_{JMAX} = 150^{\circ}C$, $\theta_{JA} = 150^{\circ}C/W$</p>	ORDER PART NUMBER
	LT1813DMS8*		LT1813CS8 LT1813IS8 LT1813DS8*
	MS8 PART MARKING		S8 PART MARKING
	LTGZ		1813 1813I 1813D

Consult factory for Military grade parts. *See note 9.

ELECTRICAL CHARACTERISTICS $T_A = 25^{\circ}C$, $V_S = \pm 5V$, $V_{CM} = 0V$ unless otherwise noted.

SYMBOL	PARAMETER	CONDITIONS	MIN	TYP	MAX	UNITS
V_{OS}	Input Offset Voltage	(Note 4)		0.5	1.5	mV
I_{OS}	Input Offset Current			50	400	nA
I_B	Input Bias Current			-0.9	± 4	μA
e_n	Input Noise Voltage	$f = 10kHz$		8		nV/\sqrt{Hz}
i_n	Input Noise Current	$f = 10kHz$		1		pA/\sqrt{Hz}
R_{IN}	Input Resistance	$V_{CM} = \pm 3.5V$ Differential	3	10 1.5		$M\Omega$ $M\Omega$
C_{IN}	Input Capacitance			2		pF
	Input Voltage Range (High)		3.5	4.2		V
	Input Voltage Range (Low)			-4.2	-3.5	V
CMRR	Common Mode Rejection Ratio	$V_{CM} = \pm 3.5V$	75	85		dB
PSRR	Power Supply Rejection Ratio	$V_S = \pm 2V$ to $\pm 5.5V$	78	96		dB
A_{VOL}	Large-Signal Voltage Gain	$V_{OUT} = \pm 3V$, $R_L = 500\Omega$ $V_{OUT} = \pm 3V$, $R_L = 100\Omega$	1.5 1.0	3.0 2.5		V/mV V/mV
V_{OUT}	Output Swing	$R_L = 500\Omega$, 30mV Overdrive $R_L = 100\Omega$, 30mV Overdrive	± 3.80 ± 3.35	± 4.0 ± 3.5		V V
I_{OUT}	Output Current	$V_{OUT} = \pm 3V$, 30mV Overdrive	± 40	± 60		mA
I_{SC}	Short-Circuit Current	$V_{OUT} = 0V$, $V_{IN} = \pm 1V$	± 75	± 100		mA
SR	Slew Rate	$A_V = -1$ (Note 5)	500	750		V/ μs
	Full Power Bandwidth	3V Peak (Note 6)		40		MHz

ELECTRICAL CHARACTERISTICS

$T_A = 25^\circ\text{C}$, $V_S = \pm 5\text{V}$, $V_{CM} = 0\text{V}$ unless otherwise noted.

SYMBOL	PARAMETER	CONDITIONS	MIN	TYP	MAX	UNITS
GBW	Gain Bandwidth	$f = 200\text{kHz}$	75	100		MHz
t_r, t_f	Rise Time, Fall Time	$A_V = 1$, 10% to 90%, 0.1V , $R_L = 100\Omega$		2		ns
	Overshoot	$A_V = 1$, 0.1V , $R_L = 100\Omega$		25		%
	Propagation Delay	50% V_{IN} to 50% V_{OUT} , 0.1V , $R_L = 100\Omega$		2.8		ns
R_O	Output Resistance	$A_V = 1$, $f = 1\text{MHz}$		0.4		Ω
	Channel Separation	$V_{OUT} = \pm 3\text{V}$, $R_L = 100\Omega$	82	90		dB
I_S	Supply Current	Per Amplifier		3	3.6	mA

$T_A = 25^\circ\text{C}$, $V_S = 5\text{V}$, $V_{CM} = 2.5\text{V}$, R_L to 2.5V unless otherwise noted.

SYMBOL	PARAMETER	CONDITIONS	MIN	TYP	MAX	UNITS
V_{OS}	Input Offset Voltage	(Note 4)		0.7	2	mV
I_{OS}	Input Offset Current			50	400	nA
I_B	Input Bias Current			-1	± 4	μA
e_n	Input Noise Voltage	$f = 10\text{kHz}$		8		$\text{nV}/\sqrt{\text{Hz}}$
i_n	Input Noise Current	$f = 10\text{kHz}$		1		$\text{pA}/\sqrt{\text{Hz}}$
R_{IN}	Input Resistance	$V_{CM} = 1.5\text{V}$ to 3.5V Differential	3	20		$\text{M}\Omega$ $\text{M}\Omega$
C_{IN}	Input Capacitance			2		pF
	Input Voltage Range (High)		3.5	4		V
	Input Voltage Range (Low)			1	1.5	V
CMRR	Common Mode Rejection Ratio	$V_{CM} = 1.5\text{V}$ to 3.5V	73	82		dB
A_{VOL}	Large-Signal Voltage Gain	$V_{OUT} = 1.5\text{V}$ to 3.5V , $R_L = 500\Omega$ $V_{OUT} = 1.5\text{V}$ to 3.5V , $R_L = 100\Omega$	1.0 0.7	2.0 1.5		V/mV V/mV
V_{OUT}	Output Swing (High)	$R_L = 500\Omega$, 30mV Overdrive $R_L = 100\Omega$, 30mV Overdrive	3.9 3.7	4.1 3.9		V V
	Output Swing (Low)	$R_L = 500\Omega$, 30mV Overdrive $R_L = 100\Omega$, 30mV Overdrive		0.9 1.1	1.1 1.3	V V
I_{OUT}	Output Current	$V_{OUT} = 3.5\text{V}$ or 1.5V , 30mV Overdrive	± 25	± 35		mA
I_{SC}	Short-Circuit Current	$V_{OUT} = 2.5\text{V}$, $V_{IN} = \pm 1\text{V}$	± 55	± 75		mA
SR	Slew Rate	$A_V = -1$ (Note 5)	200	350		$\text{V}/\mu\text{s}$
	Full Power Bandwidth	1V Peak (Note 6)		55		MHz
GBW	Gain Bandwidth	$f = 200\text{kHz}$	65	94		MHz
t_r, t_f	Rise Time, Fall Time	$A_V = 1$, 10% to 90%, 0.1V , $R_L = 100\Omega$		2.1		ns
	Overshoot	$A_V = 1$, 0.1V , $R_L = 100\Omega$		25		%
	Propagation Delay	50% V_{IN} to 50% V_{OUT} , 0.1V , $R_L = 100\Omega$		3		ns
R_O	Output Resistance	$A_V = 1$, $f = 1\text{MHz}$		0.45		Ω
	Channel Separation	$V_{OUT} = 1.5\text{V}$ to 3.5V , $R_L = 100\Omega$	81	92		dB
I_S	Supply Current	Per Amplifier		2.9	3.6	mA

ELECTRICAL CHARACTERISTICS

The ● denotes the specifications which apply over the temperature range

$0^\circ\text{C} \leq T_A \leq 70^\circ\text{C}$. $V_S = \pm 5\text{V}$, $V_{CM} = 0\text{V}$ unless otherwise noted (Note 9).

SYMBOL	PARAMETER	CONDITIONS	MIN	TYP	MAX	UNITS
V_{OS}	Input Offset Voltage	(Note 4)			2	mV
	Input V_{OS} Drift	(Note 7)		10	15	$\mu\text{V}/^\circ\text{C}$
I_{OS}	Input Offset Current				500	nA
I_B	Input Bias Current				± 5	μA

ELECTRICAL CHARACTERISTICS The ● denotes the specifications which apply over the temperature range $0^{\circ}\text{C} \leq T_A \leq 70^{\circ}\text{C}$. $V_S = \pm 5\text{V}$, $V_{CM} = 0\text{V}$ unless otherwise noted (Note 9).

SYMBOL	PARAMETER	CONDITIONS	MIN	TYP	MAX	UNITS
	Input Voltage Range (High) Input Voltage Range (Low)		● ●	3.5	-3.5	V V
CMRR	Common Mode Rejection Ratio	$V_{CM} = \pm 3.5\text{V}$	●	73		dB
PSRR	Power Supply Rejection Ratio	$V_S = \pm 2\text{V}$ to $\pm 5.5\text{V}$	●	76		dB
A_{VOL}	Large-Signal Voltage Gain	$V_{OUT} = \pm 3\text{V}$, $R_L = 500\Omega$ $V_{OUT} = \pm 3\text{V}$, $R_L = 100\Omega$	● ●	1.0 0.7		V/mV V/mV
V_{OUT}	Output Swing	$R_L = 500\Omega$, 30mV Overdrive $R_L = 100\Omega$, 30mV Overdrive	● ●	± 3.70 ± 3.25		V V
I_{OUT}	Output Current	$V_{OUT} = \pm 3\text{V}$, 30mV Overdrive	●	± 35		mA
I_{SC}	Short-Circuit Current	$V_{OUT} = 0\text{V}$, $V_{IN} = \pm 1\text{V}$	●	± 60		mA
SR	Slew Rate	$A_V = -1$ (Note 5)	●	400		V/ μs
GBW	Gain Bandwidth	$f = 200\text{kHz}$	●	65		MHz
	Channel Separation	V_{OUT} , $\pm 3\text{V}$, $R_L = 100\Omega$	●	81		dB
I_S	Supply Current	Per Amplifier	●		4.5	mA

$0^{\circ}\text{C} \leq T_A \leq 70^{\circ}\text{C}$, $V_S = 5\text{V}$, $V_{CM} = 2.5\text{V}$, R_L to 2.5V unless otherwise noted (Note 9).

V_{OS}	Input Offset Voltage	(Note 4)	●		2.5	mV
	Input V_{OS} Drift	(Note 7)	●	10	15	$\mu\text{V}/^{\circ}\text{C}$
I_{OS}	Input Offset Current		●		500	nA
I_B	Input Bias Current		●		± 5	μA
	Input Voltage Range (High) Input Voltage Range (Low)		● ●	3.5	1.5	V V
CMRR	Common Mode Rejection Ratio	$V_{CM} = 1.5\text{V}$ to 3.5V	●	71		dB
A_{VOL}	Large-Signal Voltage Gain	$V_{OUT} = 1.5\text{V}$ to 3.5V , $R_L = 500\Omega$ $V_{OUT} = 1.5\text{V}$ to 3.5V , $R_L = 100\Omega$	● ●	0.7 0.5		V/mV V/mV
V_{OUT}	Output Swing (High)	$R_L = 500\Omega$, 30mV Overdrive $R_L = 100\Omega$, 30mV Overdrive	● ●	3.8 3.6		V V
	Output Swing (Low)	$R_L = 500\Omega$, 30mV Overdrive $R_L = 100\Omega$, 30mV Overdrive	● ●		1.2 1.4	V V
I_{OUT}	Output Current	$V_{OUT} = 3.5\text{V}$ or 1.5V , 30mV Overdrive	●	± 20		mA
I_{SC}	Short-Circuit Current	$V_{OUT} = 2.5\text{V}$, $V_{IN} = \pm 1\text{V}$	●	± 45		mA
SR	Slew Rate	$A_V = -1$ (Note 5)	●	150		V/ μs
GBW	Gain Bandwidth	$f = 200\text{kHz}$	●	55		MHz
	Channel Separation	V_{OUT} , 1.5V to 3.5V, $R_L = 100\Omega$	●	80		dB
I_S	Supply Current	Per Amplifier	●		4.5	mA

$-40^{\circ}\text{C} \leq T_A \leq 85^{\circ}\text{C}$. $V_S = \pm 5\text{V}$, $V_{CM} = 0\text{V}$ unless otherwise noted (Notes 8, 9).

SYMBOL	PARAMETER	CONDITIONS	MIN	TYP	MAX	UNITS
V_{OS}	Input Offset Voltage	(Note 4)	●		3	mV
	Input V_{OS} Drift	(Note 7)	●	10	30	$\mu\text{V}/^{\circ}\text{C}$
I_{OS}	Input Offset Current		●		600	nA
I_B	Input Bias Current		●		± 6	μA
	Input Voltage Range (High) Input Voltage Range (Low)		● ●	3.5	-3.5	V V
CMRR	Common Mode Rejection Ratio	$V_{CM} = \pm 3.5\text{V}$	●	72		dB
PSRR	Power Supply Rejection Ratio	$V_S = \pm 2\text{V}$ to $\pm 5.5\text{V}$	●	75		dB

ELECTRICAL CHARACTERISTICS The ● denotes the specifications which apply over the temperature range $-40^{\circ}\text{C} \leq T_A \leq 85^{\circ}\text{C}$. $V_S = \pm 5\text{V}$, $V_{CM} = 0\text{V}$ unless otherwise noted (Notes 8, 9).

SYMBOL	PARAMETER	CONDITIONS	MIN	TYP	MAX	UNITS
A _{VOL}	Large-Signal Voltage Gain	V _{OUT} = ±3V, R _L = 500Ω	●	0.8		V/mV
		V _{OUT} = ±3V, R _L = 100Ω	●	0.6		V/mV
V _{OUT}	Output Swing	R _L = 500Ω, 30mV Overdrive	●	±3.60		V
		R _L = 100Ω, 30mV Overdrive	●	±3.15		V
I _{OUT}	Output Current	V _{OUT} = ±3V, 30mV Overdrive	●	±30		mA
I _{SC}	Short-Circuit Current	V _{OUT} = 0V, V _{IN} = ±1V	●	±55		mA
SR	Slew Rate	A _V = -1 (Note 5)	●	350		V/μs
GBW	Gain Bandwidth	f = 200kHz	●	60		MHz
	Channel Separation	V _{OUT} , ±3V, R _L = 100Ω	●	80		dB
I _S	Supply Current	Per Amplifier	●		5	mA

$-40^{\circ}\text{C} \leq T_A \leq 85^{\circ}\text{C}$, $V_S = 5\text{V}$, $V_{CM} = 2.5\text{V}$, R_L to 2.5V unless otherwise noted (Notes 8, 9).

V _{OS}	Input Offset Voltage	(Note 4)	●		3.5	mV
	Input V _{OS} Drift	(Note 7)	●	10	30	μV/°C
I _{OS}	Input Offset Current		●		600	nA
I _B	Input Bias Current		●		±6	μA
	Input Voltage Range (High) Input Voltage Range (Low)		● ●	3.5	1.5	V V
CMRR	Common Mode Rejection Ratio	V _{CM} = 1.5V to 3.5V	●	70		dB
A _{VOL}	Large-Signal Voltage Gain	V _{OUT} = 1.5V to 3.5V, R _L = 500Ω	●	0.6		V/mV
		V _{OUT} = 1.5V to 3.5V, R _L = 100Ω	●	0.4		V/mV
V _{OUT}	Output Swing (High)	R _L = 500Ω, 30mV Overdrive R _L = 100Ω, 30mV Overdrive	● ●	3.7 3.5		V V
	Output Swing (Low)	R _L = 500Ω, 30mV Overdrive R _L = 100Ω, 30mV Overdrive	● ●		1.3 1.5	V V
I _{OUT}	Output Current	V _{OUT} = 3.5V or 1.5V, 30mV Overdrive	●	±17		mA
I _{SC}	Short-Circuit Current	V _{OUT} = 2.5V, V _{IN} = ±1V	●	±40		mA
SR	Slew Rate	A _V = -1 (Note 5)	●	125		V/μs
GBW	Gain Bandwidth	f = 200kHz	●	50		MHz
	Channel Separation	V _{OUT} , 1.5V to 3.5V, R _L = 100Ω	●	79		dB
I _S	Supply Current	Per Amplifier	●		5	mA

Note 1: Absolute Maximum Ratings are those values beyond which the life of a device may be impaired.

Note 2: Differential inputs of ±3V are appropriate for transient operation only, such as during slewing. Large sustained differential inputs can cause excessive power dissipation and may damage the part.

Note 3: A heat sink may be required to keep the junction temperature below absolute maximum when the output is shorted indefinitely.

Note 4: Input offset voltage is pulse tested and is exclusive of warm-up drift.

Note 5: Slew rate is measured between ±2V on the output with ±3V input for ±5V supplies and 2V_{P-P} on the output with a 3V_{P-P} input for single 5V supplies.

Note 6: Full power bandwidth is calculated from the slew rate:

$$\text{FPBW} = \text{SR}/2\pi V_P$$

Note 7: This parameter is not 100% tested.

Note 8: The LT1813C is guaranteed to meet specified performance from 0°C to 70°C and is designed, characterized and expected to meet these extended temperature limits, but is not tested at -40°C and 85°C. The LT1813I is guaranteed to meet the extended temperature limits.

Note 9: The LT1813D is 100% production tested at 25°C. It is designed, characterized and expected to meet the 0°C to 70°C specifications although it is not tested or QA sampled at these temperatures. The LT1813D is guaranteed functional from -40°C to 85°C but may not meet those specifications.

TYPICAL PERFORMANCE CHARACTERISTICS

Supply Current vs Temperature

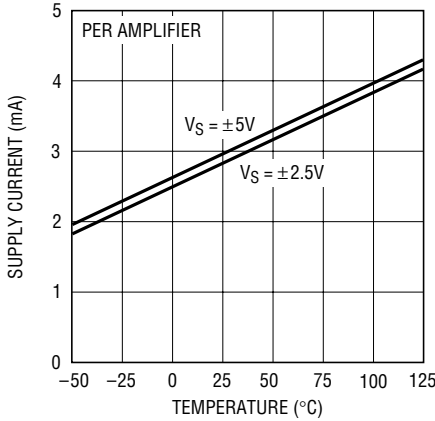

1813 G01

Input Common Mode Range vs Supply Voltage

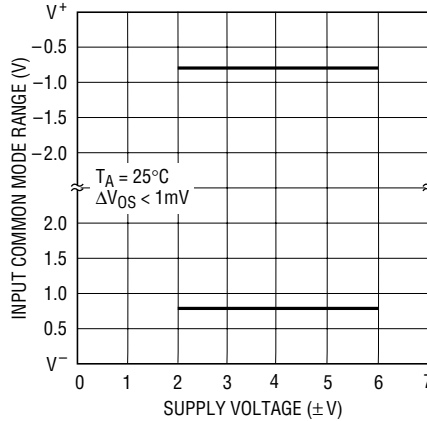

1813 G02

Input Bias Current vs Common Mode Voltage

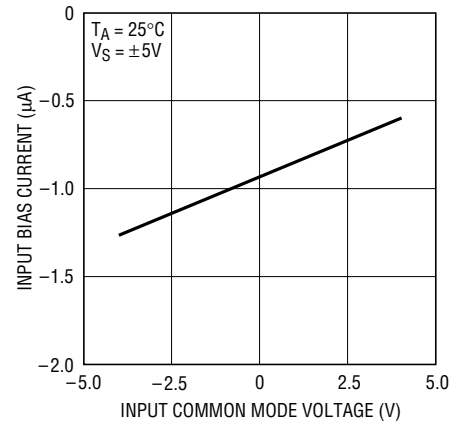

1813 G03

Input Bias Current vs Temperature

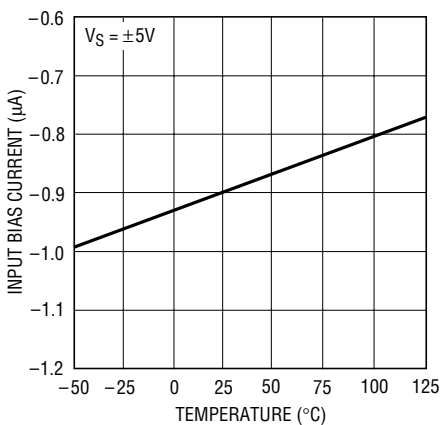

1813 G04

Input Noise Spectral Density

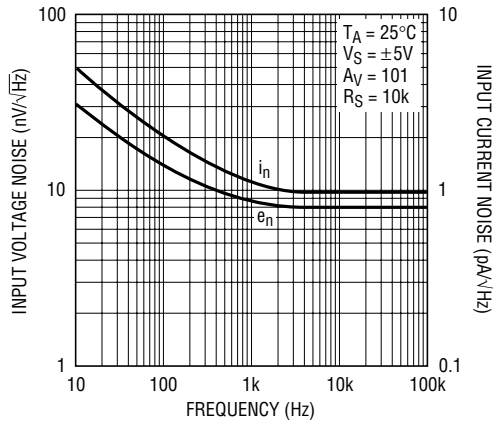

1813 G05

Open-Loop Gain vs Resistive Load

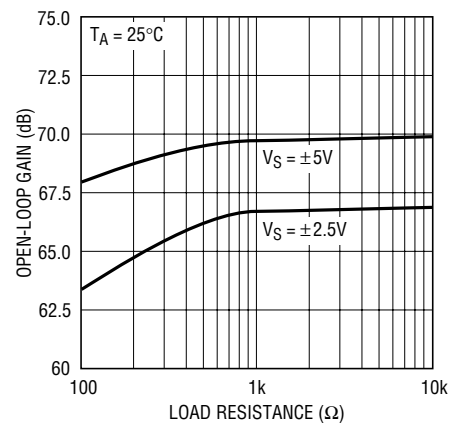

1813 G06

Open-Loop Gain vs Temperature

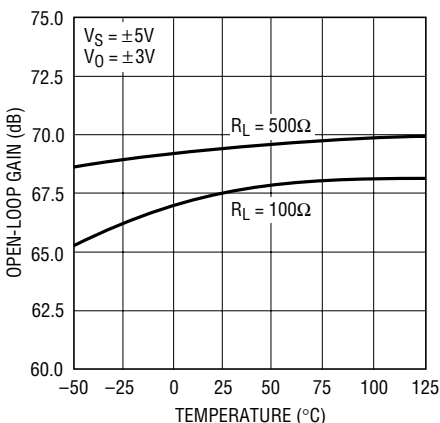

1813 G07

Output Voltage Swing vs Supply Voltage

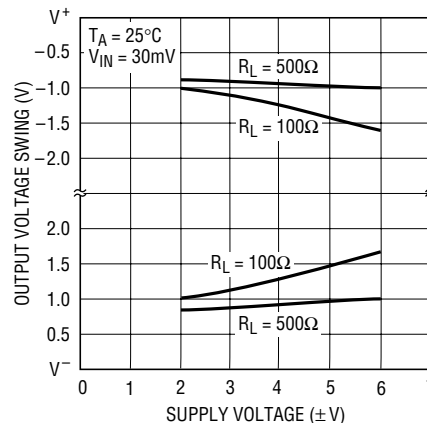

1813 G02

Output Voltage Swing vs Load Current

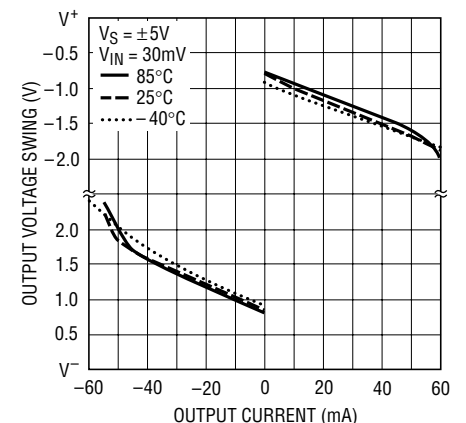

1813 G09

TYPICAL PERFORMANCE CHARACTERISTICS

Output Short-Circuit Current vs Temperature

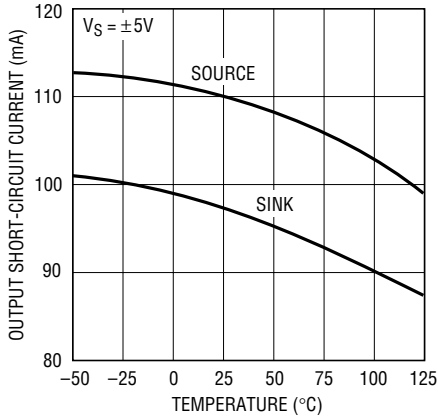

1813 G10

Settling Time vs Output Step

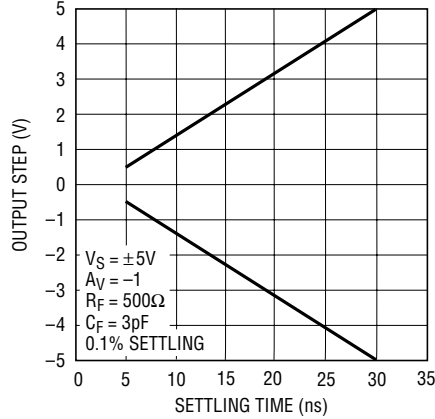

1813 G11

Output Impedance vs Frequency

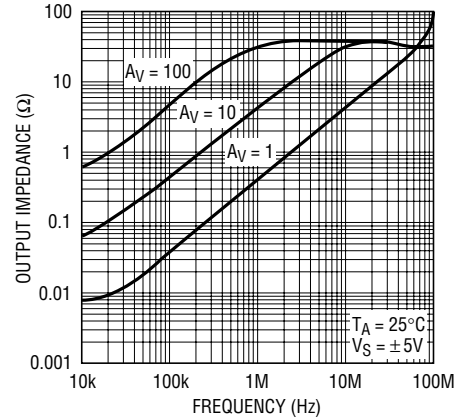

1813 G12

Gain and Phase vs Frequency

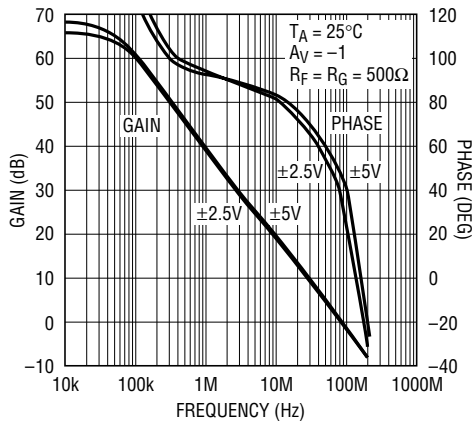

1813 G13

Crosstalk vs Frequency

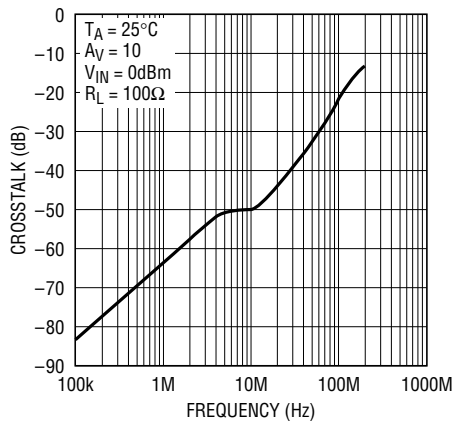

1813 G14

Gain Bandwidth and Phase Margin vs Temperature

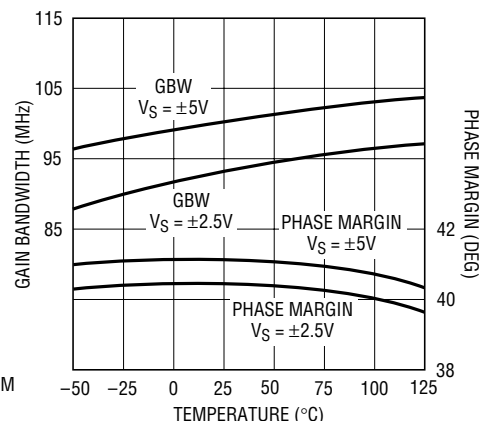

1813 G15

Frequency Response vs Supply Voltage, A_V = 1

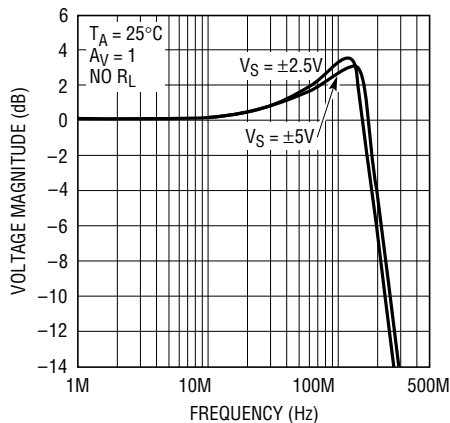

1813 G16

Frequency Response vs Supply Voltage, A_V = 2

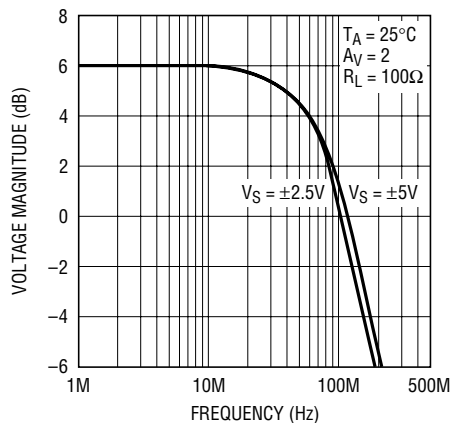

1813 G17

Frequency Response vs Capacitive Load, A_V = -1

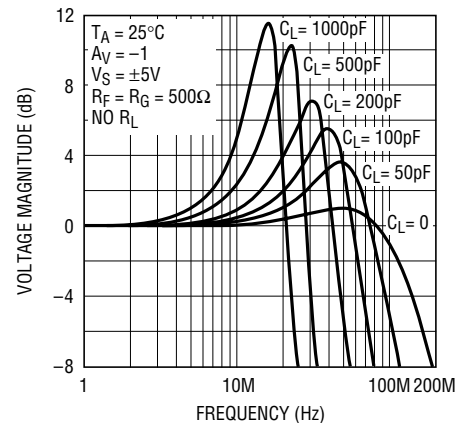

1813 G18

TYPICAL PERFORMANCE CHARACTERISTICS

Gain Bandwidth and Phase Margin vs Supply Voltage

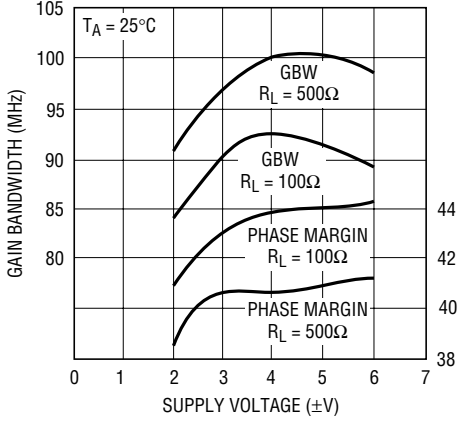

1813 G19

Power Supply Rejection Ratio vs Frequency

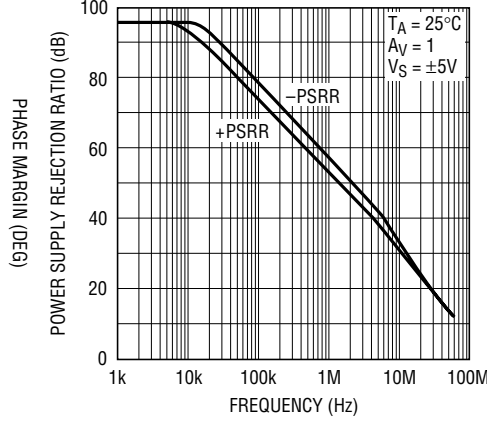

1813 G20

Common Mode Rejection Ratio vs Frequency

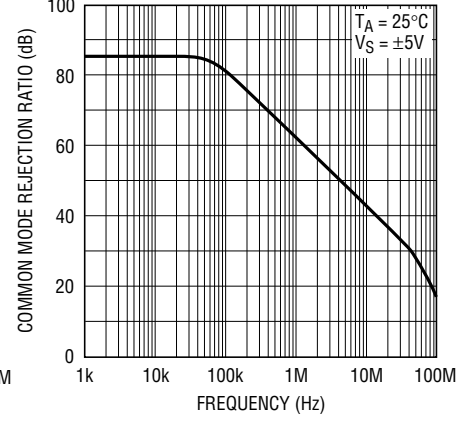

1813 G21

Slew Rate vs Supply Voltage

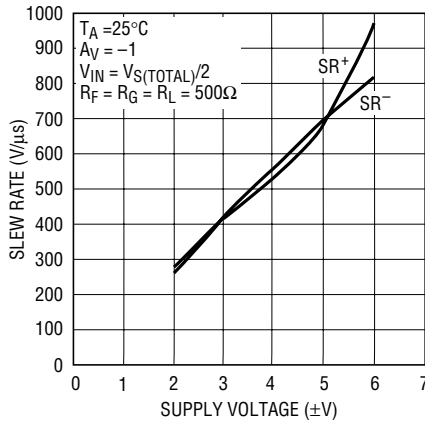

1813 G22

Slew Rate vs Supply Voltage

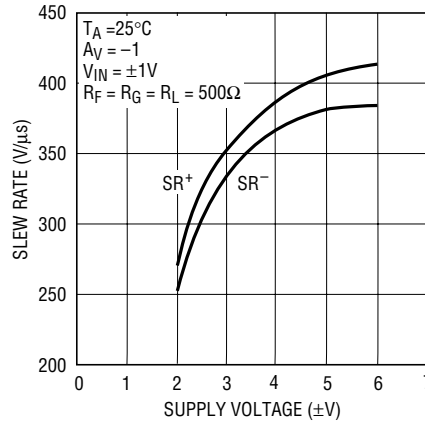

1813 G23

Slew Rate vs Input Level

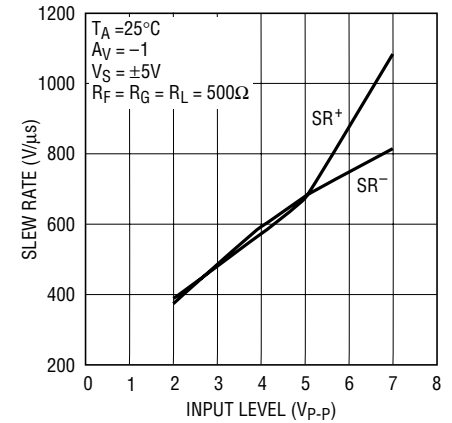

1813 G24

Slew Rate vs Temperature

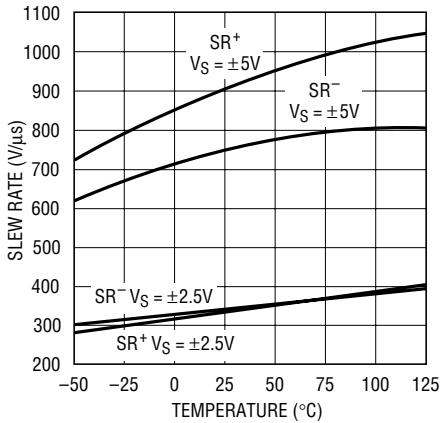

1813 G25

Total Harmonic Distortion + Noise vs Frequency

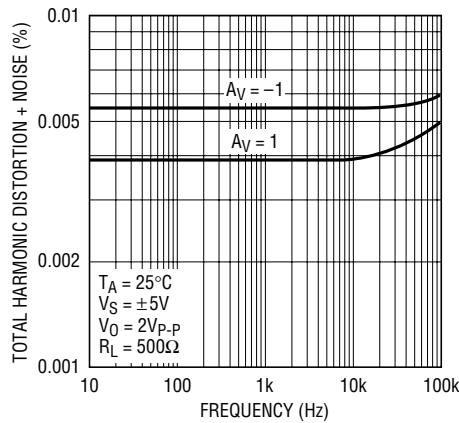

1813 G26

Undistorted Output Swing vs Frequency

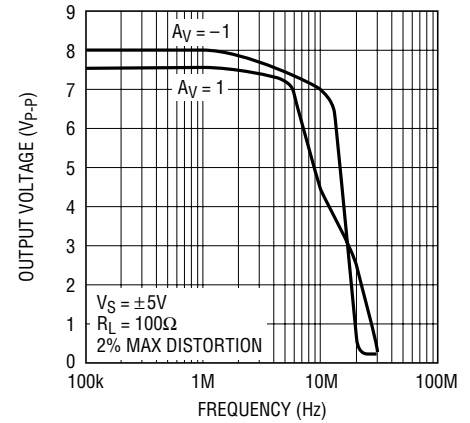

1813 G27

TYPICAL PERFORMANCE CHARACTERISTICS

2nd and 3rd Harmonic Distortion vs Frequency

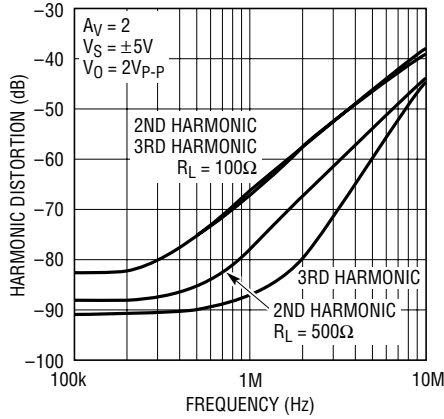

1813 G28

Differential Gain and Phase vs Supply Voltage

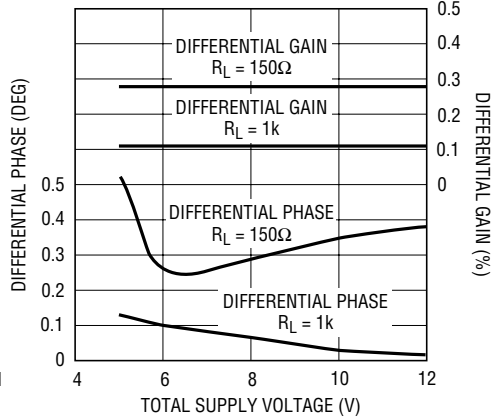

1813 G29

Capacitive Load Handling

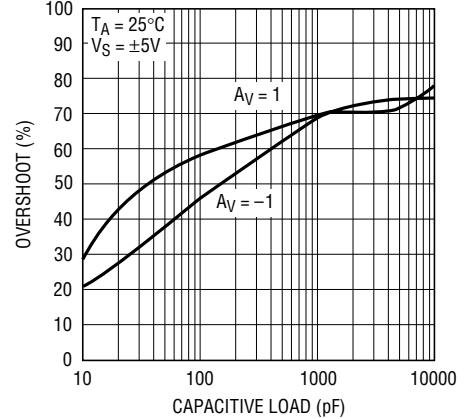

1813 G30

Small-Signal Transient ($A_V = 1$)

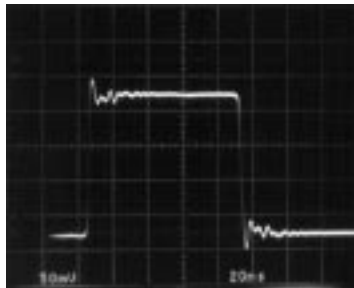

1813 G31

Small-Signal Transient ($A_V = -1$)

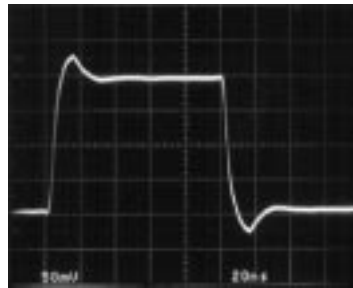

1813 G32

Small-Signal Transient ($A_V = 1$, $C_L = 100pF$)

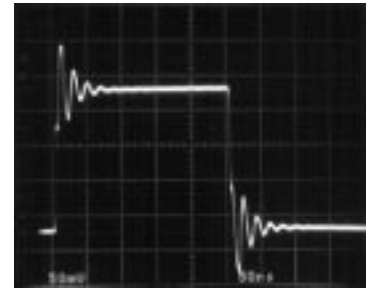

1813 G33

Large-Signal Transient ($A_V = 1$)

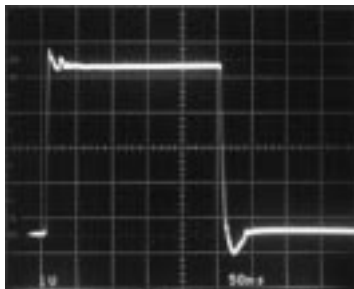

1813 G34

Large-Signal Transient ($A_V = -1$)



1813 G35

Large-Signal Transient ($A_V = -1$, $C_L = 200pF$)

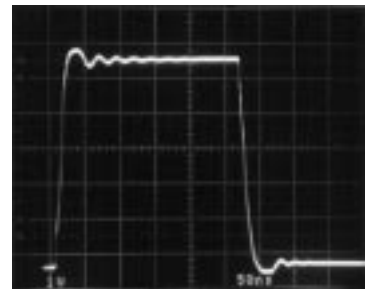

1813 G36

APPLICATIONS INFORMATION

Layout and Passive Components

The LT1813 amplifier is more tolerant of less than ideal layouts than other high speed amplifiers. For maximum performance (for example, fast settling) use a ground plane, short lead lengths and RF-quality bypass capacitors (0.01 μ F to 0.1 μ F). For high drive current applications, use low ESR bypass capacitors (1 μ F to 10 μ F tantalum).

The parallel combination of the feedback resistor and gain setting resistor on the inverting input combine with the input capacitance to form a pole that can cause peaking or oscillations. If feedback resistors greater than 2k are used, a parallel capacitor of value

$$C_F > R_G \cdot C_{IN}/R_F$$

should be used to cancel the input pole and optimize dynamic performance. For applications where the DC noise gain is 1 and a large feedback resistor is used, C_F should be greater than or equal to C_{IN} . An example would be an I-to-V converter.

Input Considerations

Each of the LT1813 amplifier inputs is the base of an NPN and PNP transistor whose base currents are of opposite polarity and provide first-order bias current cancellation. Because of variation in the matching of NPN and PNP beta, the polarity of the input current can be positive or negative. The offset current does not depend on beta matching and is well controlled. The use of balanced source resistance at each input is recommended for applications where DC accuracy must be maximized. The inputs can withstand differential input voltages of up to 3V without damage and need no clamping or source resistance for protection. Differential inputs generate the large supply currents (up to 40mA) required for high slew rates. Typically, power dissipation does not significantly increase in normal, closed-loop operation because of the low duty cycle of the transient inputs.

The device should not be used as a comparator because with sustained differential inputs, excessive power dissipation may result.

Capacitive Loading

The LT1813 is stable with a 1000pF capacitive load which is outstanding for a 100MHz amplifier. This is accomplished by sensing the load induced output pole and adding compensation at the amplifier gain node. As the capacitive load increases, both the bandwidth and phase margin decrease so there will be peaking in the frequency domain and in the transient response. Coaxial cable can be driven directly, but for best pulse fidelity, a resistor of value equal to the characteristic impedance of the cable (i.e., 75 Ω) should be placed in series with the output. The other end of the cable should be terminated with the same value resistor to ground.

Slew Rate

The slew rate is proportional to the differential input voltage. Highest slew rates are therefore seen in the lowest gain configurations. For example, a 5V output step in a gain of 10 has a 0.5V input step, whereas in unity gain there is a 5V input step. The LT1813 is tested for slew rate in a gain of -1. Lower slew rates occur in higher gain configurations.

Power Dissipation

The LT1813 combines high speed and large output drive in a small package. It is possible to exceed the maximum junction temperature under certain conditions. Maximum junction temperature (T_J) is calculated from the ambient temperature (T_A) and power dissipation (P_D) as follows:

$$\text{LT1813CS8: } T_J = T_A + (P_D \cdot 150^\circ\text{C/W})$$

Power dissipation is composed of two parts. The first is due to the quiescent supply current and the second is due to on-chip dissipation caused by the load current.

The worst-case load induced power occurs when the output voltage is at 1/2 of either supply voltage (or the maximum swing if less than 1/2 supply voltage). For each amplifier:

$$P_{D\text{MAX}} = (V^+ - V^-)(I_{S\text{MAX}}) + (V^+/2)^2/R_L \text{ or}$$

$$P_{D\text{MAX}} = (V^+ - V^-)(I_{S\text{MAX}}) + (V^+ - V_{O\text{MAX}})(V_{O\text{MAX}}/R_L)$$

APPLICATIONS INFORMATION

Example: LT1813 in SO-8 at 70°C, $V_S = \pm 5V$, $R_L = 100\Omega$

$$P_{D_{MAX}} = (10V)(4.5mA) + (2.5V)^2/100\Omega = 108mW$$

$$T_{J_{MAX}} = 70^\circ C + (2 \cdot 108mW)(150^\circ C/W) = 102^\circ C$$

Circuit Operation

The LT1813 circuit topology is a true voltage feedback amplifier that has the slewing behavior of a current feedback amplifier. The operation of the circuit can be understood by referring to the Simplified Schematic. The inputs are buffered by complementary NPN and PNP emitter followers which drive a 300Ω resistor. The input voltage appears across the resistor generating currents that are mirrored into the high impedance node.

Complementary followers form an output stage that buffers the gain node from the load. The bandwidth is set by the input resistor and the capacitance on the high impedance node. The slew rate is determined by the current available to charge the gain node capacitance. This current

is the differential input voltage divided by R1, so the slew rate is proportional to the input. Highest slew rates are therefore seen in the lowest gain configurations.

The RC network across the output stage is bootstrapped when the amplifier is driving a light or moderate load and has no effect under normal operation. When driving capacitive loads (or a low value resistive load) the network is incompletely bootstrapped and adds to the compensation at the high impedance node. The added capacitance slows down the amplifier which improves the phase margin by moving the unity-gain cross away from the pole formed by the output impedance and the capacitive load. The zero created by the RC combination adds phase to ensure that the total phase lag does not exceed 180 degrees (zero phase margin) and the amplifier remains stable. In this way, the LT1813 is stable with up to 1000pF capacitive loads in unity gain, and even higher capacitive loads in higher closed-loop gain configurations.

SIMPLIFIED SCHEMATIC

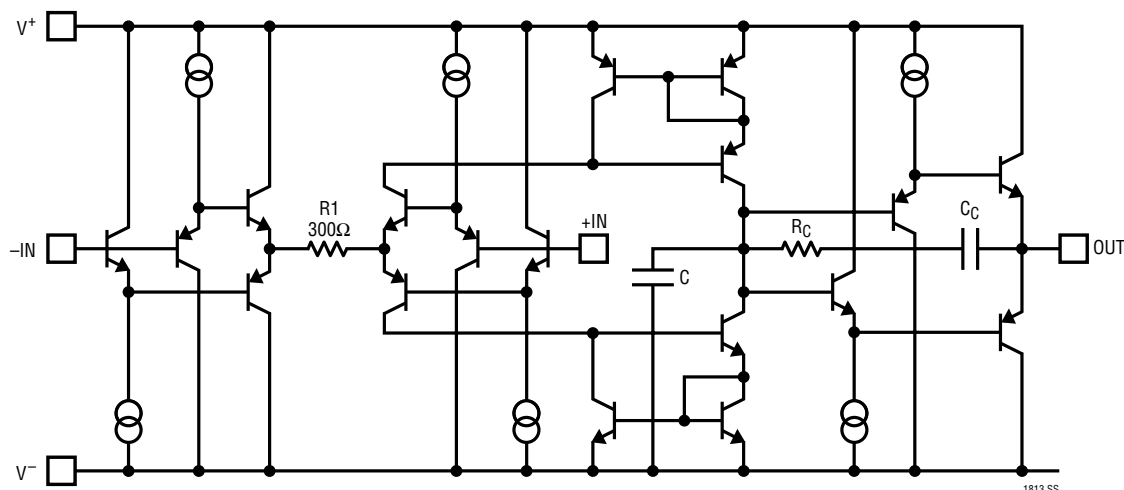

TYPICAL APPLICATION

Two Op Amp Instrumentation Amplifier

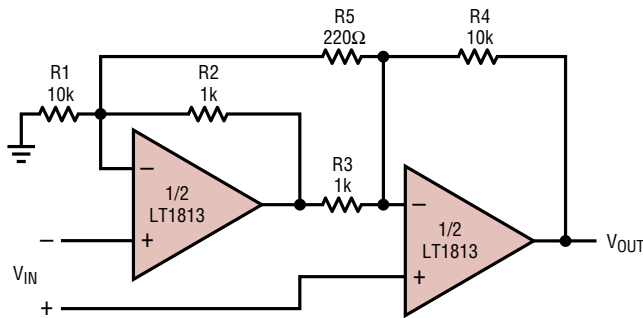

$$GAIN = \left[\frac{R4}{R3} \right] \left[1 + \left(\frac{1}{2} \right) \left(\frac{R2}{R1} + \frac{R3}{R4} \right) + \frac{(R2+R3)}{R5} \right] = 102$$

TRIM R5 FOR GAIN
 TRIM R1 FOR COMMON MODE REJECTION
 BW = 1MHz

1813 TA03

PACKAGE DESCRIPTION

MS8 Package
8-Lead Plastic MSOP
 (LTC DWG # 05-08-1660)

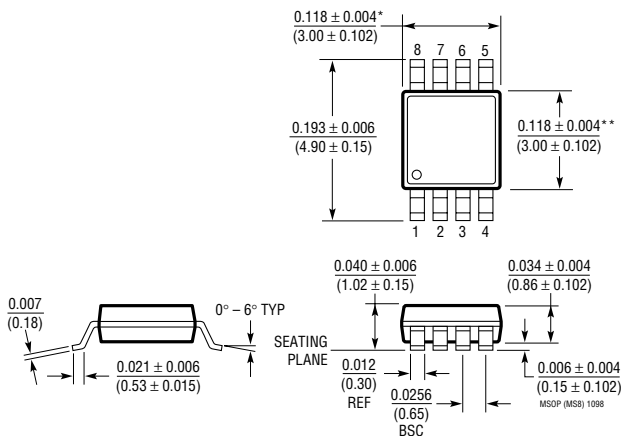

* DIMENSION DOES NOT INCLUDE MOLD FLASH, PROTRUSIONS OR GATE BURRS. MOLD FLASH, PROTRUSIONS OR GATE BURRS SHALL NOT EXCEED 0.006* (0.152mm) PER SIDE

** DIMENSION DOES NOT INCLUDE INTERLEAD FLASH OR PROTRUSIONS. INTERLEAD FLASH OR PROTRUSIONS SHALL NOT EXCEED 0.006* (0.152mm) PER SIDE

S8 Package
8-Lead Plastic Small Outline (Narrow 0.150)
 (LTC DWG # 05-08-1610)

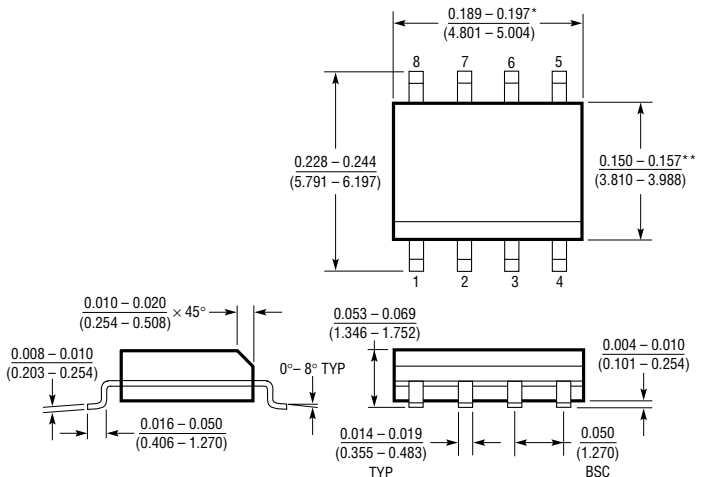

* DIMENSION DOES NOT INCLUDE MOLD FLASH. MOLD FLASH SHALL NOT EXCEED 0.006* (0.152mm) PER SIDE

** DIMENSION DOES NOT INCLUDE INTERLEAD FLASH. INTERLEAD FLASH SHALL NOT EXCEED 0.010* (0.254mm) PER SIDE

S08 1298

RELATED PARTS

PART NUMBER	DESCRIPTION	COMMENTS
LT1360/LT1361/LT1362	Single/Dual/Quad 50MHz, 800V/μs, C-Load™ Amplifiers	±15V Operation, 1mV Max V _{OS} , 1μA Max I _B
LT1363/LT1364/LT1365	Single/Dual/Quad 70MHz, 1000V/μs C-Load Amplifiers	±15V Operation, 1.5mV Max V _{OS} , 2μA Max I _B
LT1398/LT1399	Dual/Triple 300MHz Current Feedback Amplifiers	4.5mA Supply Current, 80mA Output Current, Shutdown

C-Load is a trademark of Linear Technology Corporation.