

PTB 20174

90 Watts, 1400–1600 MHz

RF Power Transistor

Description

The 20174 is an NPN, common emitter RF power transistor intended for 26 Vdc class AB operation from 1400 to 1600 MHz. Rated at 90 watts minimum output power, it may be used for both CW and PEP applications. Ion implantation, nitride surface passivation and gold metallization are used to ensure excellent device reliability. 100% lot traceability is standard.

- Class AB Characteristics
- Specified 26 Volts, 1490 MHz
 - Output Power = 90 Watts
 - IMD at 90 Watts = -28 dBc max.
 - Gain at 90 Watts = 7.5 dB min.
- Gold Metallization
- Silicon Nitride Passivated

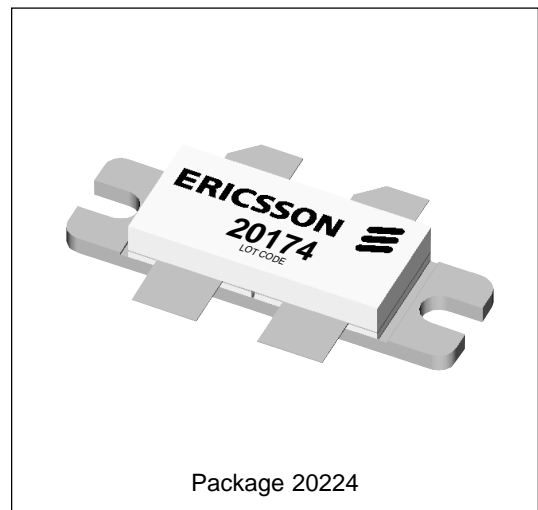
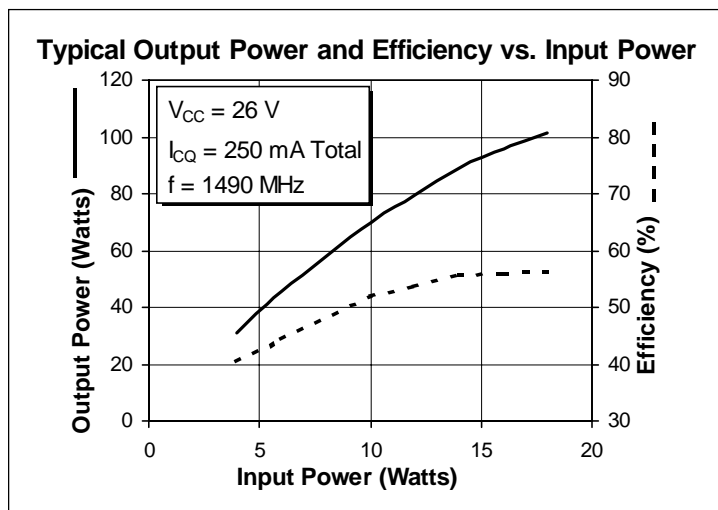

Maximum Ratings

Parameter	Symbol	Value	Unit
Collector-Emitter Voltage (collector shorted)	V_{CES}	52	Vdc
Collector-Base Voltage (emitter open)	V_{CBO}	50	Vdc
Emitter-Base Voltage (collector open)	V_{EBO}	4.0	Vdc
Collector Current (continuous)	I_C	15	Adc
Total Device Dissipation at $T_{flange} = 25^\circ\text{C}$ Above 25°C derate by	P_D	290 1.67	Watts W/ $^\circ\text{C}$
Storage Temperature	T_{STG}	150	$^\circ\text{C}$
Thermal Resistance ($T_{flange} = 70^\circ\text{C}$)	$R\theta_{JC}$	0.6	$^\circ\text{C/W}$

Electrical Characteristics (100% Tested)

Characteristic	Conditions	Symbol	Min	Typ	Max	Units
Breakdown Voltage C to E	$I_B = 0\text{ A}, I_C = 100\text{ mA}$	$V_{(BR)CEO}$	21	—	—	Volts
Breakdown Voltage C to E	$V_{BE} = 0\text{ V}, I_C = 100\text{ mA}$	$V_{(BR)CES}$	52	70	—	Volts
Breakdown Voltage E to B	$I_C = 0\text{ A}, I_E = 5\text{ mA}$	$V_{(BR)EBO}$	3.5	5	—	Volts
DC Current Gain	$V_{CE} = 5\text{ V}, I_C = 1\text{ A}$	h_{FE}	20	50	100	—

RF Specifications (100% Tested)

Characteristic	Symbol	Min	Typ	Max	Units
Gain ($V_{CC} = 26\text{ Vdc}, P_{out} = 90\text{ W}, I_{CQ} = 250\text{ mA Total}, f = 1491\text{ MHz}$)	G_{pe}	7.5	8.3	—	dB
Collector Efficiency ($V_{CC} = 26\text{ Vdc}, P_{out} = 90\text{ W}, I_{CQ} = 250\text{ mA Total}, f = 1491\text{ MHz}$)	η_C	40	45	—	%
Load Mismatch Tolerance ($V_{CC} = 26\text{ Vdc}, P_{out} = 45\text{ W}, I_{CQ} = 250\text{ mA Total}, f = 1491\text{ MHz}$ —at all phase angles)	Ψ	—	—	3:1	—

Impedance Data (data shown for fixed-tuned broadband circuit)

($V_{CC} = 26\text{ Vdc}, P_{out} = 90\text{ W}, I_{CQ} = 250\text{ mA Total}$)

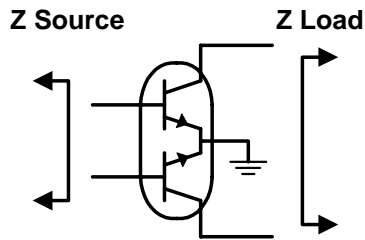

Frequency MHz	Z Source		Z Load	
	R	jX	R	jX
1400	10.0	-7.8	6.8	-6.8
1450	9.1	-6.7	5.5	-5.8
1500	8.9	-4.9	4.6	-4.8
1550	8.0	-2.7	4.2	-3.6
1600	8.0	1.0	3.6	-1.9

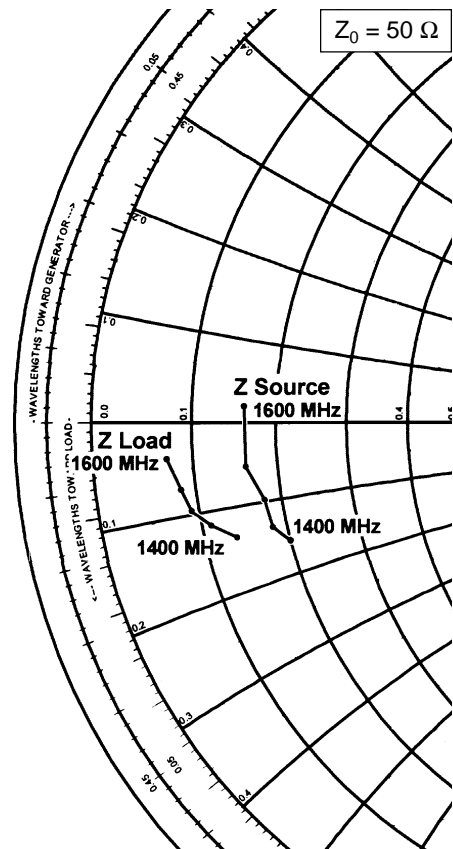

Typical Performance

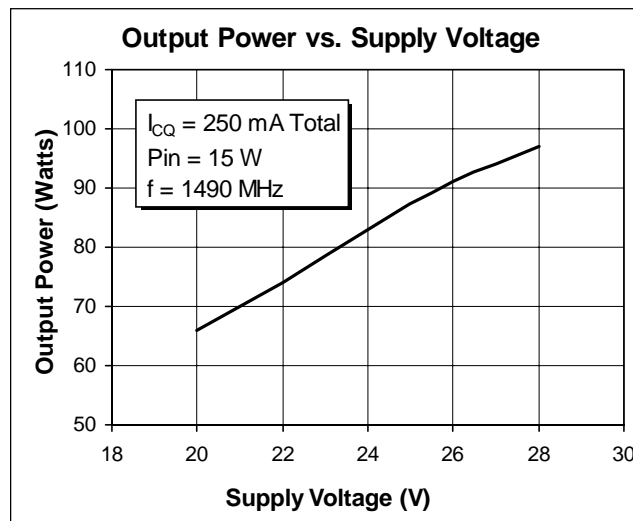
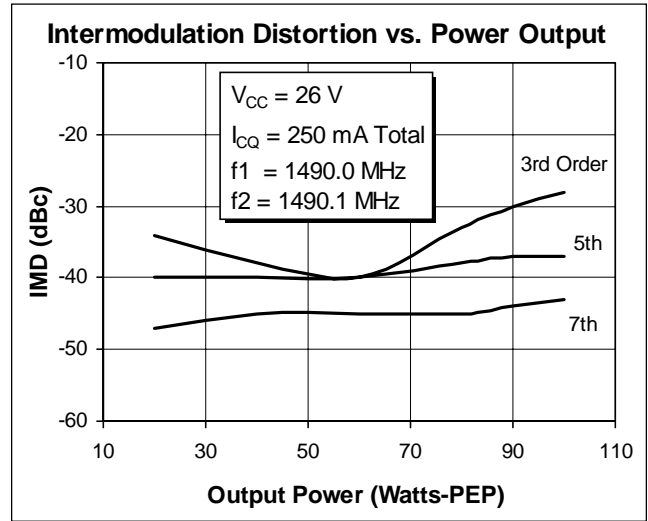
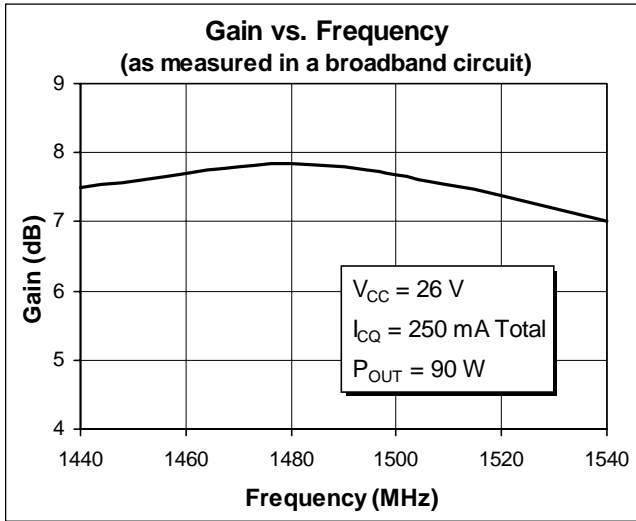

Test Circuit

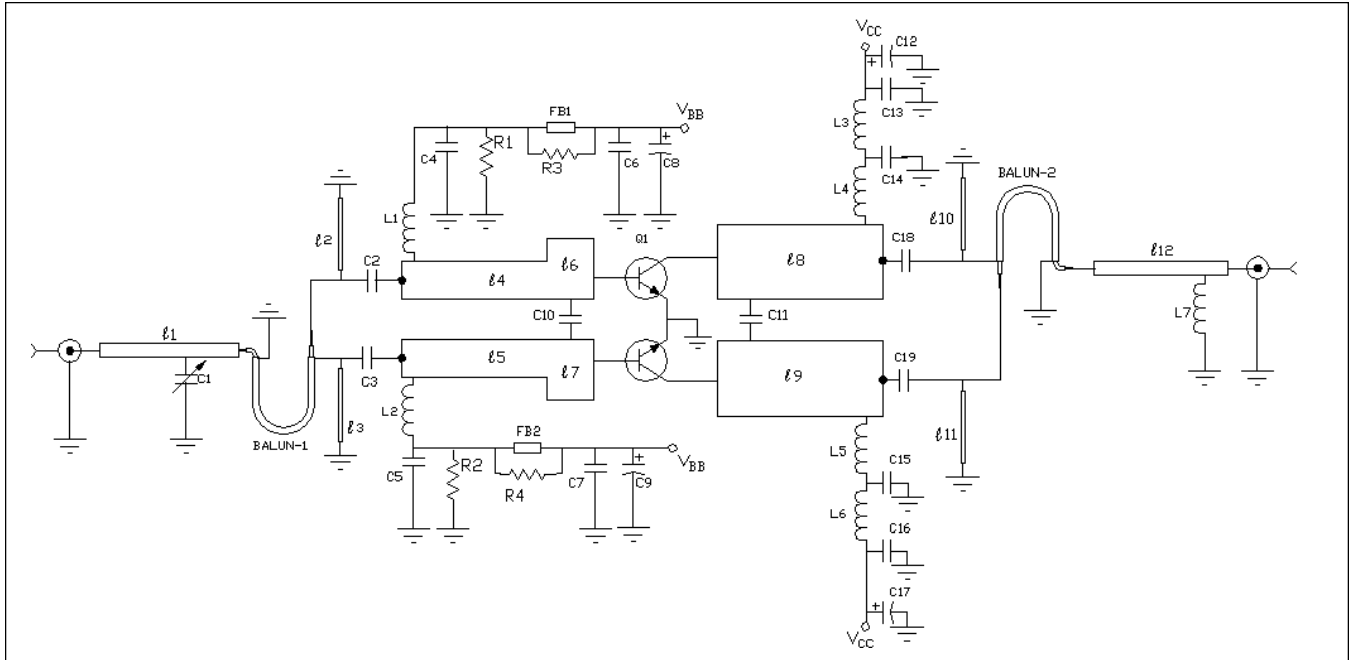

Block Diagram for $f = 1.49$ GHz

Q1	PTB 20174 — NPN RF Transistor	
l1	.410λ 1.49 GHz	Microstrip 50 Ω
l2, l3, l10, l11	.250λ 1.49 GHz	Microstrip 50 Ω
l4, l5	.190λ 1.49 GHz	Microstrip 22 Ω
l6, l7	.083λ 1.49 GHz	Microstrip 11.5 Ω
l8, l9	.225λ 1.49 GHz	Microstrip 10.5 Ω
l12	.210λ 1.49 GHz	Microstrip 50 Ω
Balun 1, 2	50 Ω Coax, Semi-Rigid, .047 O.D., 1.5" long	
C1	0.3 - 3.5 pF, Variable Capacitor Jaco 5801-PC	
C2, C3	18 pF, ATC 100 B	
C4, C5, C14, C15	33 pF, ATC 100 B	
C6, C7, C13, C16	1200 pF, ATC 100 B	
C8, C9	10 μF, 35 V Electrolytic Capacitor	
C10	0.3 pF, ATC 100 B	
C11	1.1 pF, ATC 100 B	
C12, C17	100 μF, 50 V Electrolytic Capacitor	
C18, C19	22 pF, ATC 100 B	
L1, L2, L4, L5	4 Turn, 24 AWG, .120" ID	
L3, L6	7 Turn, 24 AWG, .120" ID	
L7	1 Turn, 24 AWG, .100" ID	
R1, R2	22 Ω, 1/4 Watt Resistor	
R3, R4	12 Ω, 1/8 Watt Resistor	
FB1, FB2	Ferrite Bead	
Circuit Board	Copper Clad PTFE $\epsilon_r = 2.5$, .031" Thick	

Ericsson Components
RF Power Products
 675 Jarvis Drive
 Morgan Hill, CA 95037 USA
 Telephone: 408-778-9434

1-877-GOLDMOS
 (1-877-465-3667)
 e-mail: rfpower@ericsson.com
 www.ericsson.com/rfpower

Specifications subject to change without notice.
 LF
 © 1996 Ericsson Inc.
 EUS/KR 1301-PTB 20174 Uen Rev. D 09-28-98