

CNC1S171

Optoisolator

For isolated signal transmission

■ Features

- High current transfer ratio : CTR >50%
- High I/O isolation voltage : $V_{ISO} = 5000 V_{rms}$ (min.)
- Fast response : $t_r = 2 \mu s$, $t_f = 3 \mu s$ (typ.)
- Low dark current : $I_{CEO} < 100nA$
- VDE approved (VDE0884)
- UL listed (No. E79920)
- BSI certified (BS415 No. 7889, BS7002 No. 7890)
- SEMKO certified (No. 9625004)
- DEMKO certified (No. 305848)
- NEMKO certified (No. 199633176)
- FIMKO certified (No. 191784)
- CSA approved (No. CA109151)

■ Absolute Maximum Ratings (Ta = 25°C)

Parameter		Symbol	Ratings	Unit
Input (Light emitting diode)	Reverse voltage (DC)	V_R	6	V
	Forward current (DC)	I_F	50	mA
	Pulse forward current	I_{FP}^{*1}	1	A
	Power dissipation	P_D^{*2}	75	mW
Output (Photo transistor)	Collector current	I_C	50	mA
	Collector to emitter voltage	V_{CEO}	80	V
	Emitter to collector voltage	V_{ECO}	7	V
Collector power dissipation		P_C^{*3}	150	mW
Isolation voltage, input to output		V_{ISO}	5000	V_{rms}
Total power dissipation		P_T	200	mW
Operating ambient temperature		T_{opr}	-30 to +100	°C
Storage temperature		T_{stg}	-55 to +125	°C

■ Electrical Characteristics (Ta = 25°C)

Parameter		Symbol	Conditions	min	typ	max	Unit
Input characteristics	Reverse current (DC)	I_R	$V_R = 3V$			10	μA
	Forward voltage (DC)	V_F	$I_F = 50mA$		1.35	1.5	V
	Capacitance between pins	C_t	$V_R = 0V, f = 1MHz$			15	pF
Output characteristics	Collector cutoff current	I_{CEO}	$V_{CE} = 20V$		5	100	nA
	Collector to emitter voltage	V_{CEO}	$I_C = 100\mu A$	80			V
	Collector to emitter capacitance	C_C	$V_{CE} = 10V, f = 1MHz$		10		pF
Transfer characteristics	DC current transfer ratio	CTR^{*1*4}	$V_{CE} = 10V, I_F = 5mA$	50		600	%
	Isolation voltage, input to output	V_{ISO}	$t = 1 \text{ min.}, RH < 60\%$	5000			V_{rms}
	Isolation capacitance, input to output	C_{ISO}	$f = 1MHz$		0.7		pF
	Isolation resistance, input to output	R_{ISO}	$V_{ISO} = 500V$	10^{11}			Ω
	Rise time	t_r^{*2}	$V_{CC} = 10V, I_C = 5mA,$		2		μs
	Fall time	t_f^{*3}	$R_L = 100\Omega$		3		μs
Collector to emitter saturation voltage		$V_{CE(sat)}$	$I_F = 20mA, I_C = 1mA$	0.1	0.2		V

*1 DC current transfer ratio (CTR) is a ratio of output current against DC input current.

*2 t_r : Time required for the collector current to increase from 10% to 90% of its final value

*3 t_f : Time required for the collector current to decrease from 90% to 10% of its initial value

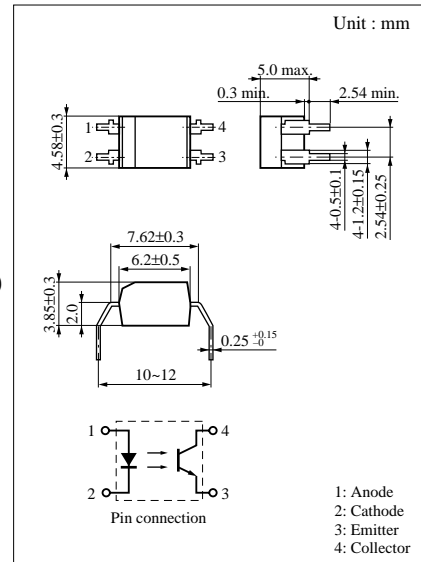

*1 Pulse width $\leq 100 \mu s$, repeat 100 pps

*2 Input power derating ratio is $0.75 \text{ mW}/^\circ\text{C}$ at $T_a \geq 25^\circ\text{C}$.

*3 Output power derating ratio is $1.5 \text{ mW}/^\circ\text{C}$ at $T_a \geq 25^\circ\text{C}$.

*4 CTR classifications

Class	Q	R	S
CTR (%)	50 to 120	100 to 250	200 to 600

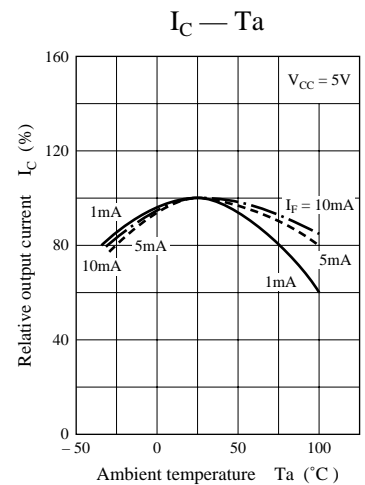
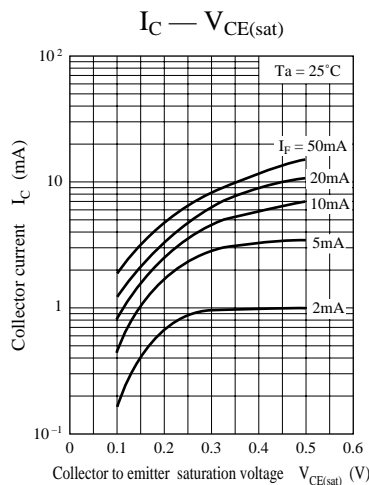
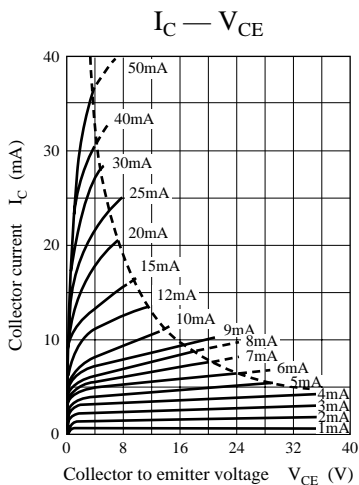
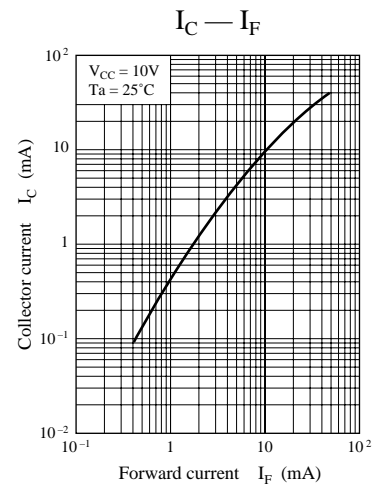
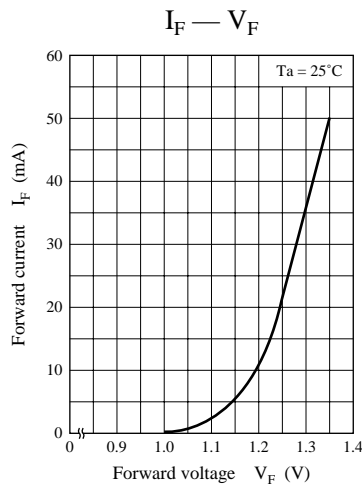
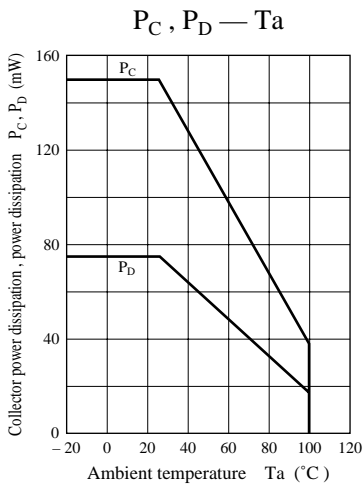

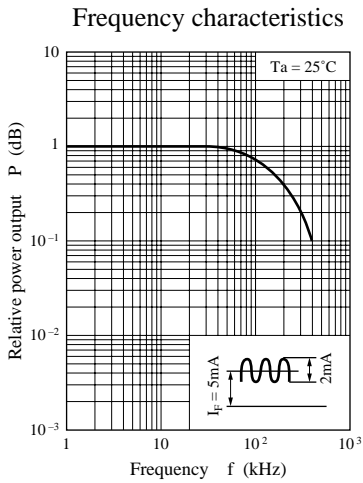
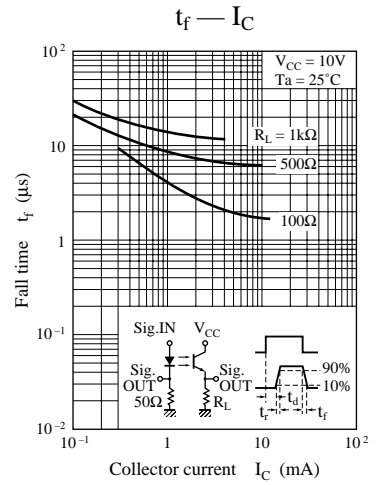
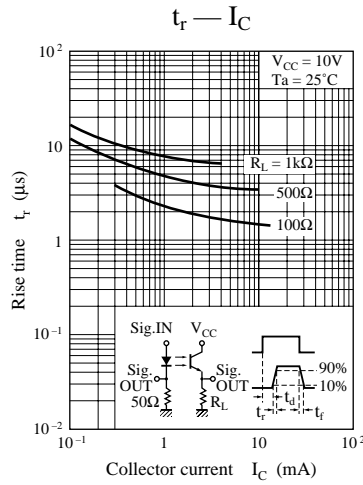
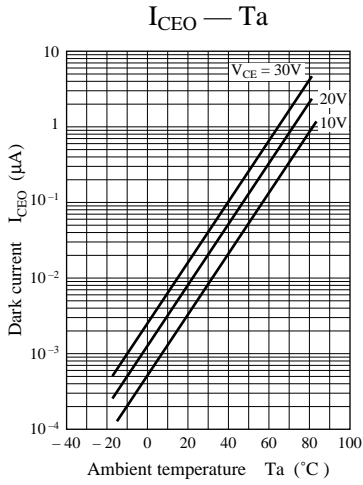

Measurement circuit of frequency characteristics

