



DISCRETE POWER DIODES and THYRISTORS
DATA BOOK



ST780C..L SERIES

PHASE CONTROL THYRISTORS

Hockey Puk Version

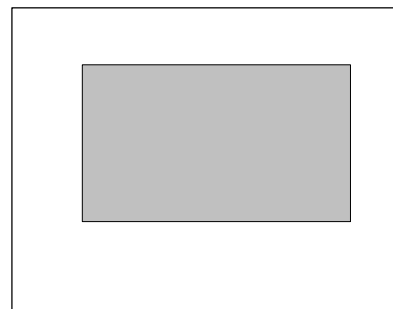
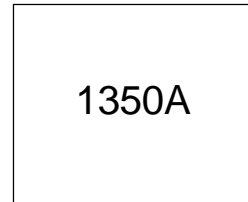

ST780C..L Series

ELECTRICAL SPECIFICATIONS

Voltage Ratings

Type number	Voltage Code	V_{DRM}/V_{RRM} , max. repetitive peak and off-state voltage V	V_{RSM} , maximum non-repetitive peak voltage V	I_{DRM}/I_{RRM} max. @ $T_J = T_J$ max mA
ST780C..L	04	400	500	80
	06	600	700	

On-state Conduction

Parameter	ST780C..L	Units	Conditions		
$I_{T(AV)}$ Max. average on-state current @ Heatsink temperature	1350 (500)	A	180° conduction, half sine wave		
	55 (85)	°C	double side (single side) cooled		
$I_{T(RMS)}$ Max. RMS on-state current	2700	A	DC @ 25°C heatsink temperature double side cooled		
I_{TSM} Max. peak, one-cycle non-repetitive surge current	24400		t = 10ms	No voltage	
	25600		t = 8.3ms	reapplied	
	20550		t = 10ms	100% V_{RRM}	
	21500	t = 8.3ms	reapplied		
I^2t Maximum I^2t for fusing	2986	KA ² s	t = 10ms	No voltage	Sinusoidal half wave, Initial $T_J = T_J$ max.
	2726		t = 8.3ms	reapplied	
	2112		t = 10ms	100% V_{RRM}	
	1928		t = 8.3ms	reapplied	
$I^2\sqrt{t}$ Maximum $I^2\sqrt{t}$ for fusing	29860	KA ² √s	t = 0.1 to 10ms, no voltage reapplied		
$V_{T(TO)1}$ Low level value of threshold voltage	0.80	V	($16.7\% \times \pi \times I_{T(AV)} < I < \pi \times I_{T(AV)}$), $T_J = T_J$ max.		
$V_{T(TO)2}$ High level value of threshold voltage	0.90		($I > \pi \times I_{T(AV)}$), $T_J = T_J$ max.		
r_{t1} Low level value of on-state slope resistance	0.14	mΩ	($16.7\% \times \pi \times I_{T(AV)} < I < \pi \times I_{T(AV)}$), $T_J = T_J$ max.		
r_{t2} High level value of on-state slope resistance	0.13		($I > \pi \times I_{T(AV)}$), $T_J = T_J$ max.		
V_{TM} Max. on-state voltage	1.31	V	$I_{pk} = 3600A$, $T_J = T_J$ max, $t_p = 10ms$ sine pulse		
I_H Maximum holding current	600	mA	$T_J = 25^\circ C$, anode supply 12V resistive load		
I_L Typical latching current	1000				

Switching

Parameter	ST780C..L	Units	Conditions
di/dt Max. non-repetitive rate of rise of turned-on current	1000	A/μs	Gate drive 20V, 20Ω, $t_r \leq 1\mu s$ $T_J = T_J$ max, anode voltage $\leq 80\% V_{DRM}$
t_d Typical delay time	1.0	μs	Gate current 1A, $di_g/dt = 1A/\mu s$ $V_d = 0.67\% V_{DRM}$, $T_J = 25^\circ C$
t_q Typical turn-off time	150		$I_{TM} = 750A$, $T_J = T_J$ max, $di/dt = 60A/\mu s$, $V_R = 50V$ $dv/dt = 20V/\mu s$, Gate 0V 100Ω, $t_p = 500\mu s$

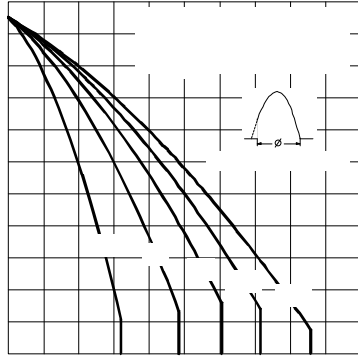

Fig. 3 - Current Ratings Characteristics

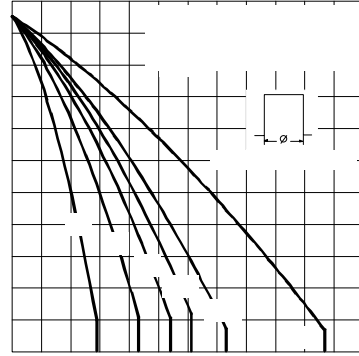

Fig. 4 - Current Ratings Characteristics

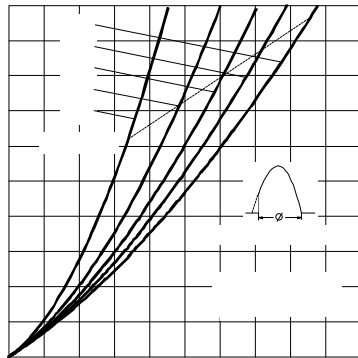

Fig. 5 - On-state Power Loss Characteristics

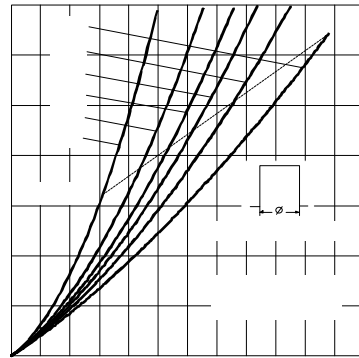

Fig. 6 - On-state Power Loss Characteristics

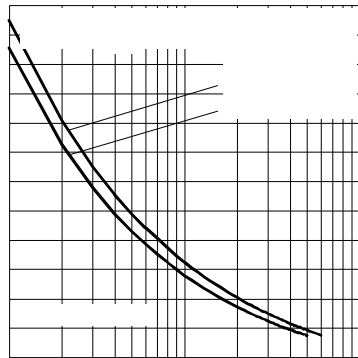

Fig. 7 - Maximum Non-Repetitive Surge Current
Single and Double Side Cooled

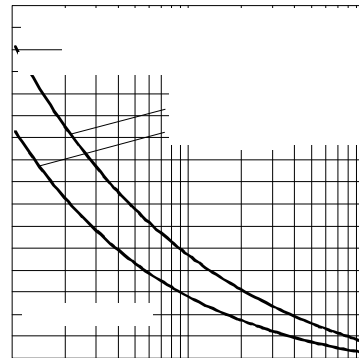

Fig. 8 - Maximum Non-Repetitive Surge Current
Single and Double Side Cooled

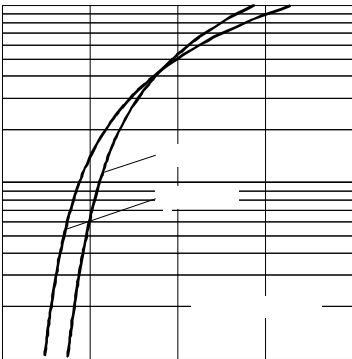

Fig. 9 - On-state Voltage Drop Characteristics

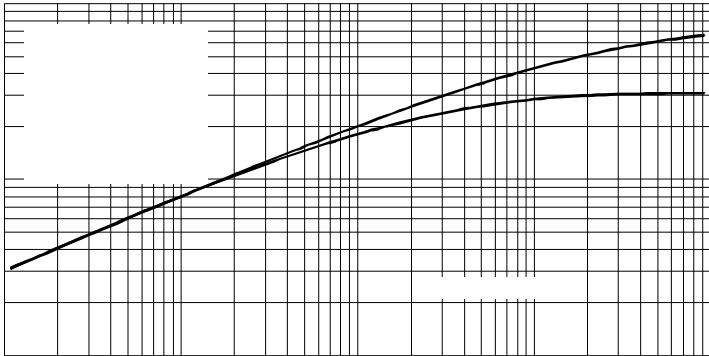

Fig. 10 - Thermal Impedance Z_{thJ-hs} Characteristics

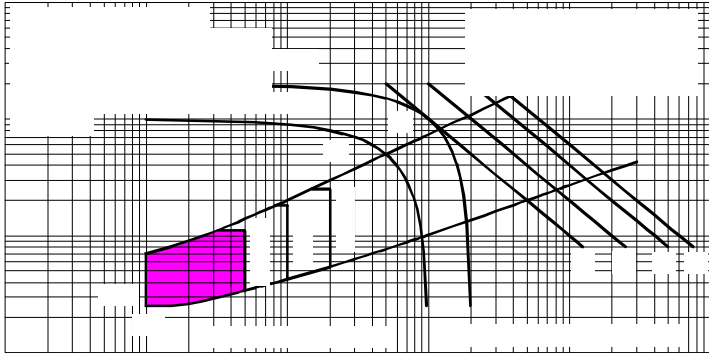

Fig. 11 - Gate Characteristics

Blocking

Parameter	ST780C..L	Units	Conditions
dv/dt Maximum critical rate of rise of off-state voltage	500	V/ μ s	$T_J = T_J$ max. linear to 80% rated V_{DRM}
I_{DRM} I_{RRM} Max. peak reverse and off-state leakage current	80	mA	$T_J = T_J$ max, rated V_{DRM}/V_{RRM} applied

Triggering

Parameter	ST780C..L	Units	Conditions
P_{GM} Maximum peak gate power	10.0	W	$T_J = T_J$ max, $t_p \leq 5$ ms
$P_{G(AV)}$ Maximum average gate power	2.0		$T_J = T_J$ max, $f = 50$ Hz, $d\% = 50$
I_{GM} Max. peak positive gate current	3.0	A	$T_J = T_J$ max, $t_p \leq 5$ ms
$+V_{GM}$ Maximum peak positive gate voltage	20	V	$T_J = T_J$ max, $t_p \leq 5$ ms
$-V_{GM}$ Maximum peak negative gate voltage	5.0		
I_{GT} DC gate current required to trigger	TYP.	MAX.	$T_J = -40^\circ\text{C}$ $T_J = 25^\circ\text{C}$ $T_J = 125^\circ\text{C}$ Max. required gate trigger/ current/ voltage are the lowest value which will trigger all units 12V anode-to-cathode applied
	200	-	
	100	200	
V_{GT} DC gate voltage required to trigger	2.5	-	$T_J = -40^\circ\text{C}$ $T_J = 25^\circ\text{C}$ $T_J = 125^\circ\text{C}$
	1.8	3.0	
	1.1	-	
I_{GD} DC gate current not to trigger	10	mA	$T_J = T_J$ max Max. gate current/voltage not to trigger is the max. value which will not trigger any unit with rated V_{DRM} anode-to-cathode applied
V_{GD} DC gate voltage not to trigger	0.25	V	

Thermal and Mechanical Specification

Parameter	ST780C..L	Units	Conditions
T_J Max. operating temperature range	-40 to 125	$^\circ\text{C}$	
T_{stg} Max. storage temperature range	-40 to 150		
R_{thJ-hs} Max. thermal resistance, junction to heatsink	0.073	K/W	DC operation single side cooled
	0.031		DC operation double side cooled
R_{thC-hs} Max. thermal resistance, case to heatsink	0.011	K/W	DC operation single side cooled
	0.006		DC operation double side cooled
F Mounting force, $\pm 10\%$	14700	N	
	(1500)	(Kg)	
wt Approximate weight	255	g	
Case style	TO - 200AC (B-PUK)		See Outline Table

ST780C..L Series

ΔR_{thJ-hs} Conduction

(The following table shows the increment of thermal resistance R_{thJ-hs} when devices operate at different conduction angles than DC)

Conduction angle	Sinusoidal conduction		Rectangular conduction		Units	Conditions
	Single Side	Double Side	Single Side	Double Side		
180°	0.009	0.009	0.006	0.006	K/W	$T_J = T_{J \text{ max.}}$
120°	0.011	0.011	0.011	0.011		
90°	0.014	0.014	0.015	0.015		
60°	0.020	0.020	0.021	0.021		
30°	0.036	0.036	0.036	0.036		

Ordering Information Table

Device Code							
ST	78	0	C	06	L	1	
①	②	③	④	⑤	⑥	⑦	⑧
1	- Thyristor	2	- Essential part number	3	- 0 = Converter grade	4	- C = Ceramic Puk
5	- Voltage code: Code x 100 = V_{RRM} (See Voltage Rating Table)	6	- L = Puk Case TO-200AC (B-PUK)	7	- 0 = Eyelet terminals (Gate and Auxiliary Cathode Unsoldered Leads) 1 = Fast-on terminals (Gate and Auxiliary Cathode Unsoldered Leads) 2 = Eyelet terminals (Gate and Auxiliary Cathode Soldered Leads) 3 = Fast-on terminals (Gate and Auxiliary Cathode Soldered Leads)	8	- Critical dv/dt: None = 500V/ μ sec (Standard selection) L = 1000V/ μ sec (Special selection)

Outline Table

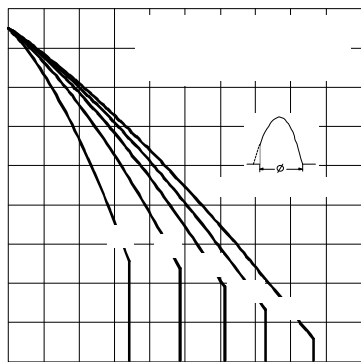
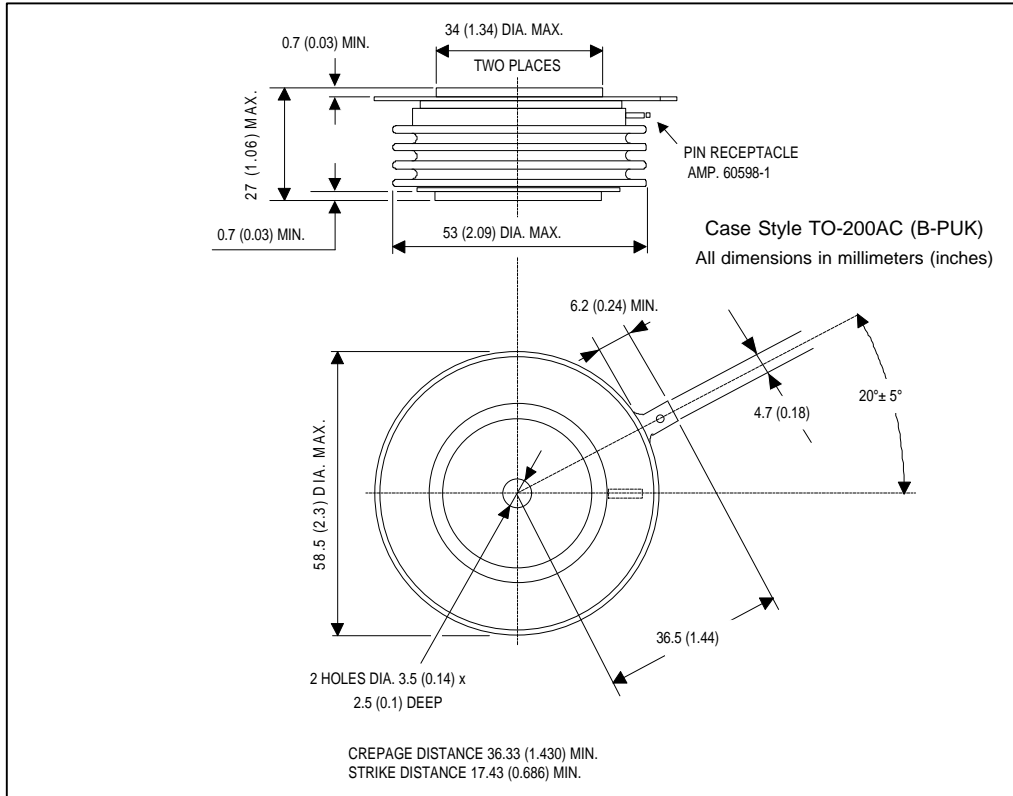

Fig. 1 - Current Ratings Characteristics

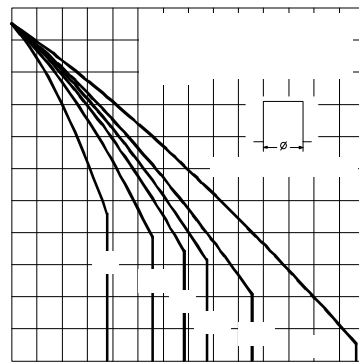

Fig. 2 - Current Ratings Characteristics