



# STGD3NB60SD

## N-CHANNEL 3A - 600V DPAK Power MESH™ IGBT

PRELIMINARY DATA

TYPE	V <sub>CES</sub>	V <sub>CE(sat)</sub>	I <sub>C</sub>
STGD3NB60SD	600 V	< 1.5 V	3 A

- HIGH INPUT IMPEDANCE (VOLTAGE DRIVEN)
- VERY LOW ON-VOLTAGE DROP (V<sub>cesat</sub>)
- HIGH CURRENT CAPABILITY
- OFF LOSSES INCLUDE TAIL CURRENT
- INTEGRATED FREEWHEELING DIODE
- SURFACE-MOUNTING DPAK (TO-252) POWER PACKAGE IN TAPE & REEL (SUFFIX "T4")

### DESCRIPTION

Using the latest high voltage technology based on a patented strip layout, STMicroelectronics has designed an advanced family of IGBTs, the PowerMESH™ IGBTs, with outstanding performances. The suffix "S" identifies a family optimized to achieve minimum on-voltage drop for low frequency applications (<1kHz).

### APPLICATIONS

- GAS DISCHARGE LAMP
- STATIC RELAYS
- MOTOR CONTROL

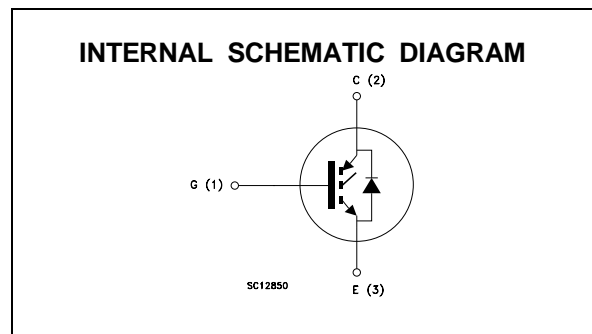
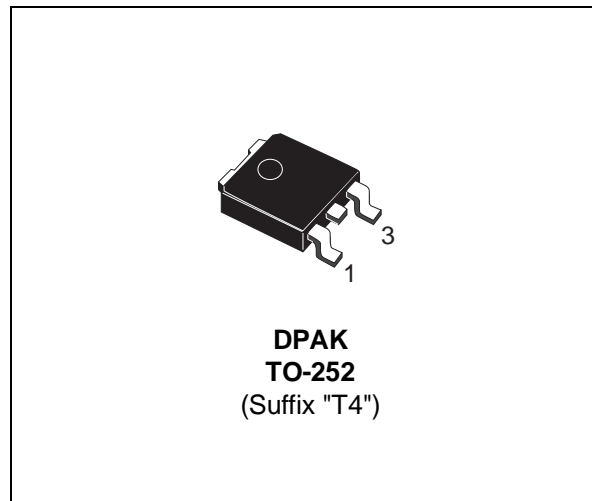

### ABSOLUTE MAXIMUM RATINGS

Symbol	Parameter	Value	Unit
V <sub>CES</sub>	Collector-Emitter Voltage (V <sub>GS</sub> = 0)	600	V
V <sub>GE</sub>	Gate-Emitter Voltage	± 20	V
I <sub>C</sub>	Collector Current (continuous) at T <sub>c</sub> = 25 °C	6	A
I <sub>C</sub>	Collector Current (continuous) at T <sub>c</sub> = 100 °C	3	A
I <sub>CM</sub> (•)	Collector Current (pulsed)	25	A
P <sub>tot</sub>	Total Dissipation at T <sub>c</sub> = 25 °C	48	W
	Derating Factor	0.32	W/°C
T <sub>stg</sub>	Storage Temperature	-65 to 175	°C
T <sub>j</sub>	Max. Operating Junction Temperature	175	°C

(•) Pulse width limited by safe operating area

## STGD3NB60SD

### THERMAL DATA

R <sub>thj-case</sub>	Thermal Resistance Junction-case	Max	3.125	°C/W
R <sub>thj-amb</sub>	Thermal Resistance Junction-ambient	Max	100	°C/W
R <sub>thc-sink</sub>	Thermal Resistance Case-sink	Typ	1.5	°C/W

### ELECTRICAL CHARACTERISTICS (T<sub>j</sub> = 25 °C unless otherwise specified)

OFF

Symbol	Parameter	Test Conditions	Min.	Typ.	Max.	Unit
V <sub>BR(CES)</sub>	Collector-Emitter Breakdown Voltage	I <sub>C</sub> = 250 μA V <sub>GE</sub> = 0	600			V
I <sub>CES</sub>	Collector cut-off (V <sub>GE</sub> = 0)	V <sub>CE</sub> = Max Rating T <sub>j</sub> = 25 °C V <sub>CE</sub> = Max Rating T <sub>j</sub> = 125 °C			10 100	μA μA
I <sub>GES</sub>	Gate-Emitter Leakage Current (V <sub>CE</sub> = 0)	V <sub>GE</sub> = ± 20 V V <sub>CE</sub> = 0			± 100	nA

ON (\*)

Symbol	Parameter	Test Conditions	Min.	Typ.	Max.	Unit
V <sub>GE(th)</sub>	Gate Threshold Voltage	V <sub>CE</sub> = V <sub>GE</sub> I <sub>C</sub> = 250 μA	2.5		5	V
V <sub>CE(SAT)</sub>	Collector-Emitter Saturation Voltage	V <sub>GE</sub> = 15 V I <sub>C</sub> = 1.5 A V <sub>GE</sub> = 15 V I <sub>C</sub> = 3 A V <sub>GE</sub> = 15 V I <sub>C</sub> = 3 A T <sub>j</sub> = 125 °C		1 1.2 1.1	1.5	V V V

### DYNAMIC

Symbol	Parameter	Test Conditions	Min.	Typ.	Max.	Unit
g <sub>fs</sub>	Forward Transconductance	V <sub>CE</sub> = 25 V I <sub>C</sub> = 3 A	1.7	2.5		S
C <sub>ies</sub> C <sub>oes</sub> C <sub>res</sub>	Input Capacitance Output Capacitance Reverse Transfer Capacitance	V <sub>CE</sub> = 25 V f = 1 MHz V <sub>GE</sub> = 0		255 30 5.6	330 40 7	pF pF pF
Q <sub>G</sub> Q <sub>GE</sub> Q <sub>GC</sub>	Total Gate Charge Gate-Emitter Charge Gate-Collector Charge	V <sub>CE</sub> = 480 V I <sub>C</sub> = 3 A V <sub>GE</sub> = 15 V		18 5.4 5.5		nC nC nC
I <sub>CL</sub>	Latching Current	V <sub>clamp</sub> = 480 V R <sub>G</sub> = 1kΩ T <sub>j</sub> = 150 °C	12			A

### SWITCHING ON

Symbol	Parameter	Test Conditions	Min.	Typ.	Max.	Unit
t <sub>d(on)</sub> t <sub>r</sub>	Delay Time Rise Time	V <sub>CC</sub> = 480 V I <sub>C</sub> = 3 A V <sub>GE</sub> = 15 V R <sub>G</sub> = 1kΩ		125 150		ns ns
(di/dt) <sub>on</sub>	Turn-on Current Slope	V <sub>CC</sub> = 480 V I <sub>C</sub> = 3 A R <sub>G</sub> = 1kΩ V <sub>GE</sub> = 15 V		50		A/μs
E <sub>on</sub>	Turn-on Switching Losses	T <sub>j</sub> = 125 °C		1100		μJ

**ELECTRICAL CHARACTERISTICS** (continued)

**SWITCHING OFF**

Symbol	Parameter	Test Conditions	Min.	Typ.	Max.	Unit
$t_c$	Cross-Over Time	$V_{CC} = 480\text{ V}$ $R_{GE} = 1\text{ k}\Omega$ $I_C = 3\text{ A}$ $V_{GE} = 15\text{ V}$		1.8		$\mu\text{S}$
$t_r(V_{off})$	Off Voltage Rise Time			1.0		$\mu\text{S}$
$t_{d(off)}$	Delay Time			3.4		$\mu\text{S}$
$t_f$	Fall Time			0.72		$\mu\text{S}$
$E_{off(**)}$	Turn-off Switching Loss			1.15		mJ
$t_c$	Cross-Over Time	$V_{CC} = 480\text{ V}$ $R_{GE} = 1\text{ k}\Omega$ $T_j = 125\text{ }^\circ\text{C}$ $I_C = 3\text{ A}$ $V_{GE} = 15\text{ V}$		2.8		$\mu\text{S}$
$t_r(V_{off})$	Off Voltage Rise Time			1.45		$\mu\text{S}$
$t_{d(off)}$	Delay Time			3.6		$\mu\text{S}$
$t_f$	Fall Time			1.2		$\mu\text{S}$
$E_{off(**)}$	Turn-off Switching Loss			1.8		mJ

**COLLECTOR-EMITTER DIODE**

Symbol	Parameter	Test Conditions	Min.	Typ.	Max.	Unit
$I_f$	Forward Current				3	A
$I_{fm}$	Forward Current pulsed				25	A
$V_f$	Forward On-Voltage	$I_f = 3\text{ A}$		1.55	1.9	V
		$I_f = 1\text{ A}$		1.15		V
$t_{rr}$	Reverse Recovery Time	$I_f = 3\text{ A}$ $dI/dt = 100\text{ A}/\mu\text{S}$ $V_R = 200\text{ V}$ $T_j = 125\text{ }^\circ\text{C}$		1700		ns
$Q_{rr}$	Reverse Recovery Charge			4500		nC
$I_{rrm}$	Reverse Recovery Current			9.5		A

- (●) Pulse width limited by max. junction temperature
- (\*) Pulsed: Pulse duration = 300  $\mu\text{s}$ , duty cycle 1.5 %
- (\*\*) Losses Include Also The Tail (Jedec Standardization)

**Thermal Impedance**

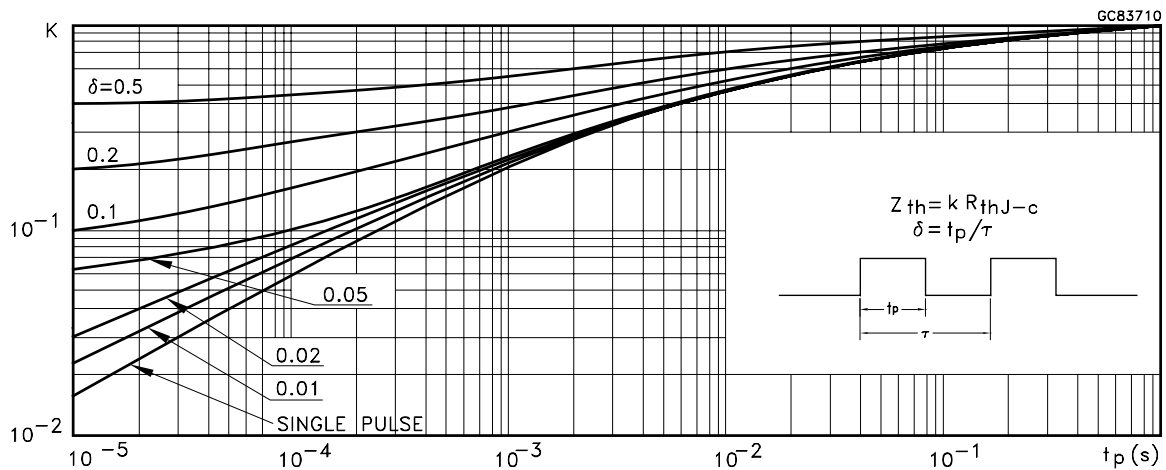

Output Characteristics

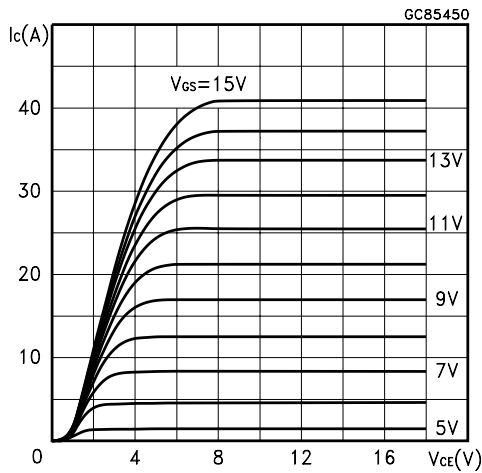

Transfer Characteristics

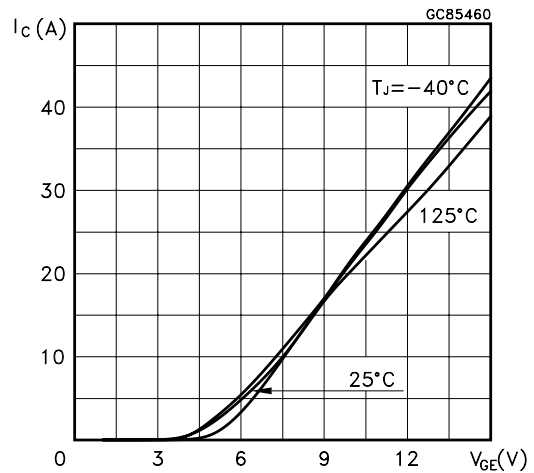

Transconductance

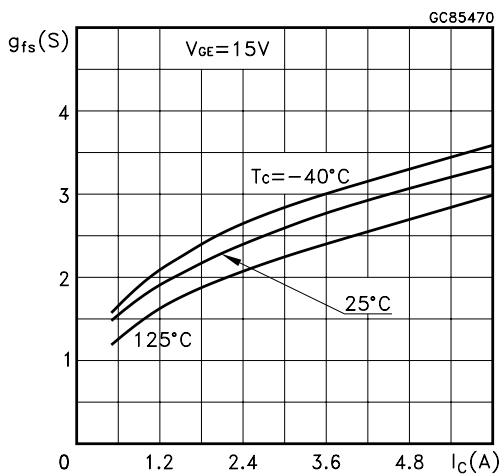

Collector-Emitter On Voltage vs Temperature

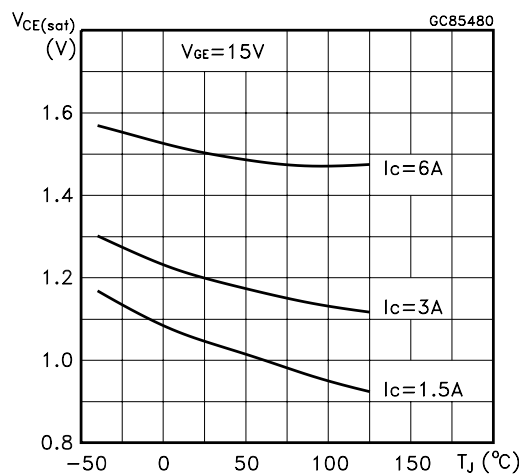

Collector-Emitter On Voltage vs Collector Current

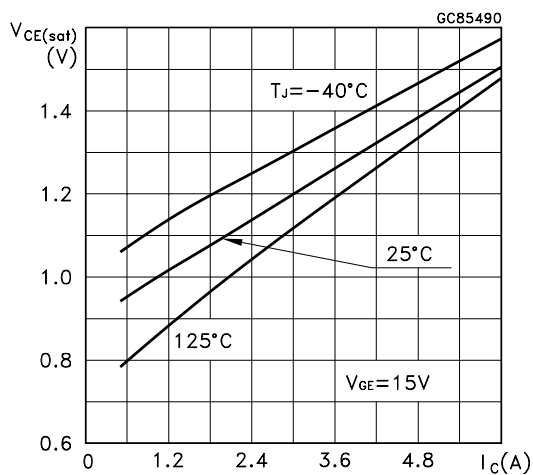

Gate Threshold vs Temperature

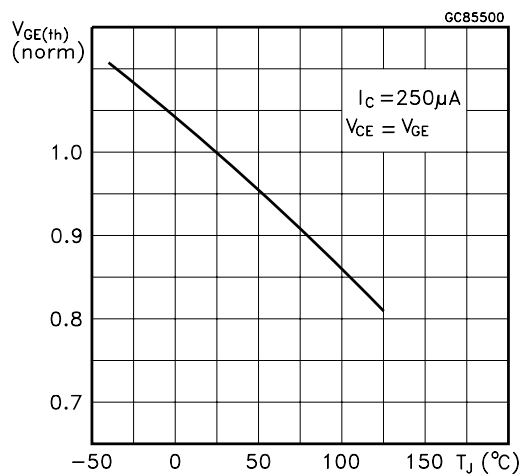

Normalized Breakdown Voltage vs Temperature

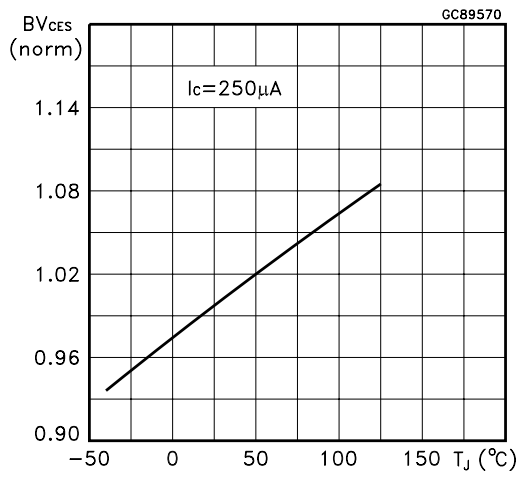

Capacitance Variations

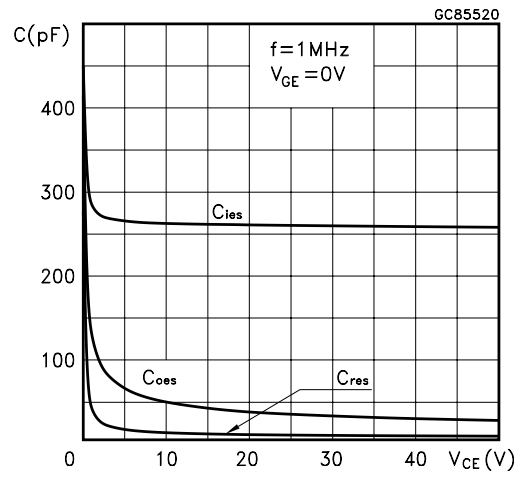

Gate Charge vs Gate-Emitter Voltage

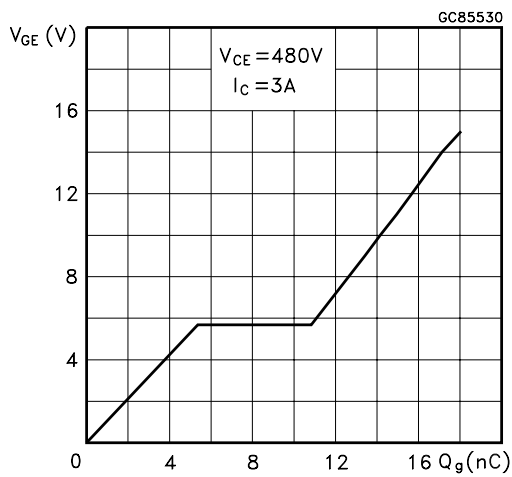

Off Switching Losses vs Ic

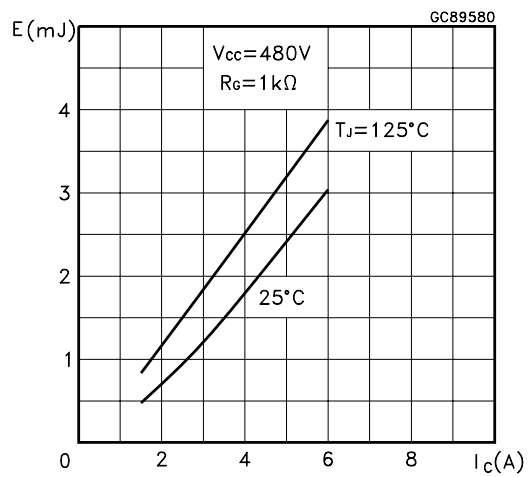

Off Switching Losses vs Tj

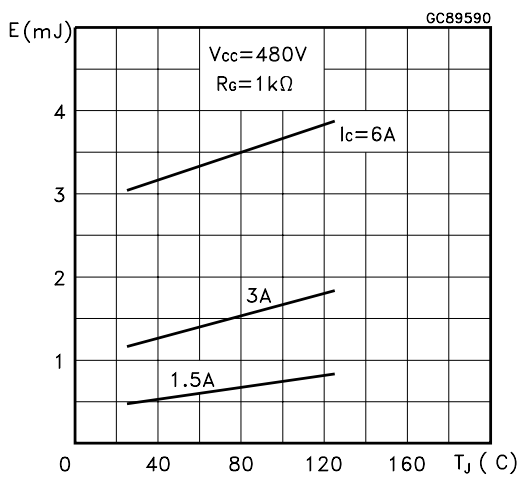

Switching Off Safe Operatin Area

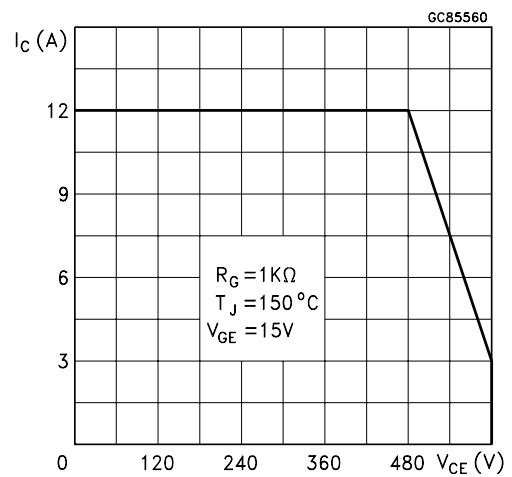



**TO-252 (DPAK) MECHANICAL DATA**

DIM.	mm			inch		
	MIN.	TYP.	MAX.	MIN.	TYP.	MAX.
A	2.2		2.4	0.086		0.094
A1	0.9		1.1	0.035		0.043
A2	0.03		0.23	0.001		0.009
B	0.64		0.9	0.025		0.035
B2	5.2		5.4	0.204		0.212
C	0.45		0.6	0.017		0.023
C2	0.48		0.6	0.019		0.023
D	6		6.2	0.236		0.244
E	6.4		6.6	0.252		0.260
G	4.4		4.6	0.173		0.181
H	9.35		10.1	0.368		0.397
L2		0.8			0.031	
L4	0.6		1	0.023		0.039

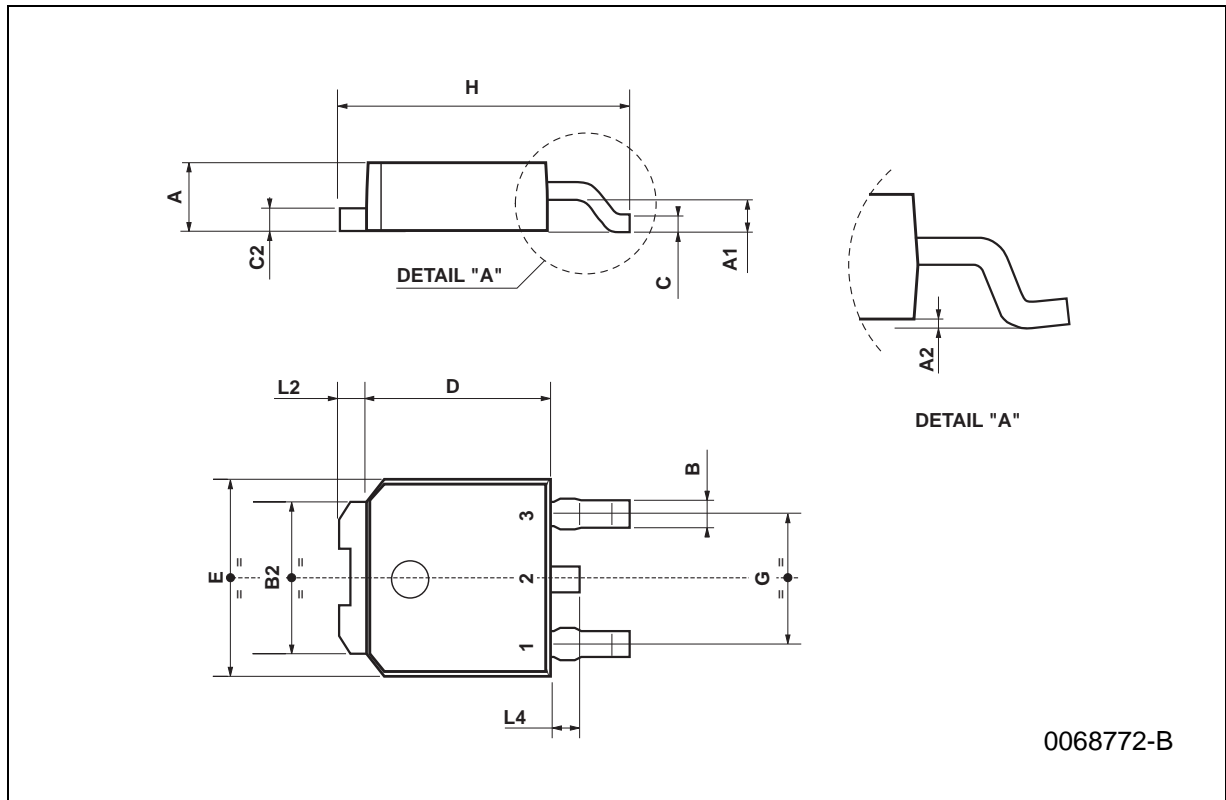

Information furnished is believed to be accurate and reliable. However, STMicroelectronics assumes no responsibility for the consequences of use of such information nor for any infringement of patents or other rights of third parties which may result from its use. No license is granted by implication or otherwise under any patent or patent rights of STMicroelectronics. Specification mentioned in this publication are subject to change without notice. This publication supersedes and replaces all information previously supplied. STMicroelectronics products are not authorized for use as critical components in life support devices or systems without express written approval of STMicroelectronics.

The ST logo is a trademark of STMicroelectronics

© 1999 STMicroelectronics – Printed in Italy – All Rights Reserved  
STMicroelectronics GROUP OF COMPANIES

Australia - Brazil - China - Finland - France - Germany - Hong Kong - India - Italy - Japan - Malaysia - Malta - Morocco -  
Singapore - Spain - Sweden - Switzerland - United Kingdom - U.S.A.

<http://www.st.com>