

TD62381P, TD62381F

8CH LOW SATURATION SINK DRIVER

The TD62381P and TD62381F are comprised of eight NPN low saturation drivers. These devices are specifically designed for multiplexed digit driving of eight digit common-cathode LED and also can be employed as a sink driver for multiplexed LED displays using with the TD62785P and TD62785F at standard supply voltage, 5V. Applications include relay, hammer, lamp and LED display drivers.

FEATURES

- Low saturation output voltage : $V_{CE(sat)} = 0.9V$ (Max.) @ $I_{out} = 500mA$
- Output rating 15V (Min.) / 500mA (Max.)
- Input compatible with TTL and 5V CMOS
- Low level active inputs
- Standard supply voltage
- Package type-P : DIP-18pin
- Package type-F : SOP-18pin

PIN CONNECTION (TOP VIEW)

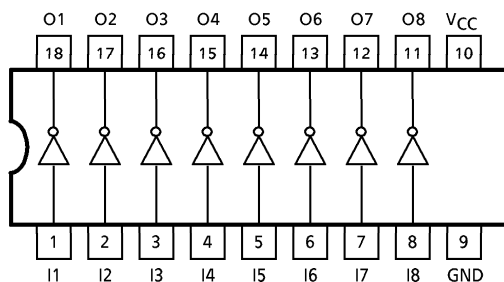

SCHEMATICS (EACH DRIVER)

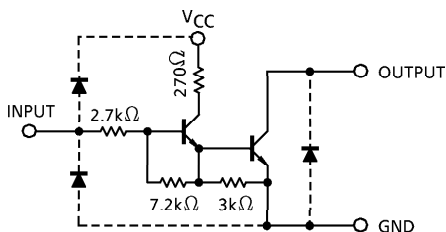

(Note) The input and output parasitic diodes cannot be used as clamp diodes.

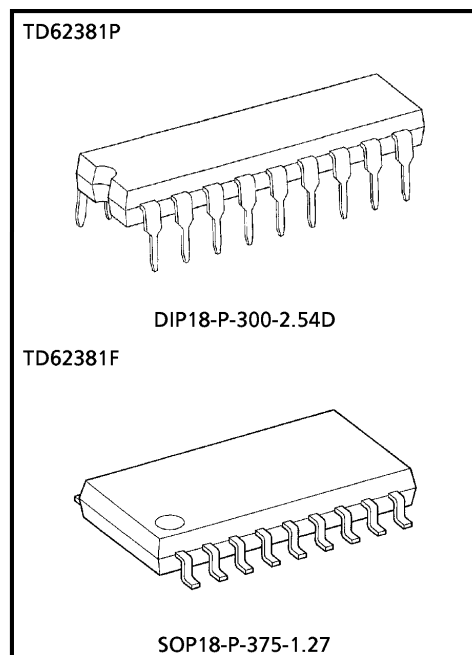

Weight
 DIP18-P-300-2.54D : 1.47g (Typ.)
 SOP18-P-375-1.27 : 0.41g (Typ.)

961001EBA2

● TOSHIBA is continually working to improve the quality and the reliability of its products. Nevertheless, semiconductor devices in general can malfunction or fail due to their inherent electrical sensitivity and vulnerability to physical stress. It is the responsibility of the buyer, when utilizing TOSHIBA products, to observe standards of safety, and to avoid situations in which a malfunction or failure of a TOSHIBA product could cause loss of human life, bodily injury or damage to property. In developing your designs, please ensure that TOSHIBA products are used within specified operating ranges as set forth in the most recent products specifications. Also, please keep in mind the precautions and conditions set forth in the TOSHIBA Semiconductor Reliability Handbook.

MAXIMUM RATINGS (Ta = 25°C)

CHARACTERISTIC	SYMBOL	RATING	UNIT	
Supply Voltage	V _{CC}	7	V	
Output Sustaining Voltage	V _{CE (SUS)}	15	V	
Output Current	I _{OUT}	500	mA / ch	
Input Voltage	V _{IN}	7	V	
Input Current	I _{IN}	5	mA	
Power Dissipation	P	P _D	1.47	W
	F	(Note)	0.96	
Operating Temperature	T _{opr}	-40~85	°C	
Storage Temperature	T _{stg}	-55~150	°C	

(Note) Delated above 25°C in the proportion of 11.7mW/°C (P-Type), 7.7mW/°C (F-Type).

RECOMMENDED OPERATING CONDITIONS (Ta = -40~85°C)

CHARACTERISTIC	SYMBOL	CONDITION	MIN.	TYP.	MAX.	UNIT		
Supply Voltage	V _{CC}	—	4.5	5.0	5.5	V		
Output Voltage	V _{OUT}	—	—	—	12	V		
Output Current	P	DC 1 Circuit, Ta = 25°C	—	—	400	mA / ch		
							F	—
	P		T _{pw} ≤ 25ms 8 Circuit On	Duty = 10%	0			
							F	Ta = 85°C T _j = 120°C
	P		—	Duty = 10%	0			
							F	—
Input Voltage	Output On	V _{IN}	—	—	V _{CC}	V		
		V _{IN (ON)}	—	2.4	V _{CC}			
		V _{IN (OFF)}	—	0	0.4			
Power Dissipation	P	P _D	—	—	0.52	W		
							F	—

ELECTRICAL CHARACTERISTICS (Ta = 25°C, V_{CC} = 5V)

CHARACTERISTIC	SYMBOL	TEST CIRCUIT	TEST CONDITION	MIN.	TYP.	MAX.	UNIT
Output Leakage Current	I _{CEX}	1	V _{IN} = OPEN V _{OUT} = 12V, Ta = 85°C	—	—	100	μA
Output Saturation Voltage	V _{CE (sat)}	2	I _{OUT} = 500mA	—	—	0.9	V
			I _{OUT} = 350mA	—	—	0.7	
Input Current	I _{IN (ON)}	3	V _{CC} = 5V, V _{IN} = 2.4V	—	0.4	0.7	mA
Input Voltage (Output On)	V _{IN (ON)}	—	V _{CC} = 5V	—	—	2.4	V
Supply Current	I _{CC}	4	V _{CC} = V _{IN} = 5V	—	—	17	mA / ch
Turn-On Delay	t _{ON}	5	V _{OUT} = 10V, R _L = 20Ω C _L = 15pF	—	0.1	—	μs
Turn-Off Delay	t _{OFF}			—	1.2	—	μs

961001EBA2'

- The products described in this document are subject to foreign exchange and foreign trade control laws.
- The information contained herein is presented only as a guide for the applications of our products. No responsibility is assumed by TOSHIBA CORPORATION for any infringements of intellectual property or other rights of the third parties which may result from its use. No license is granted by implication or otherwise under any intellectual property or other rights of TOSHIBA CORPORATION or others.
- The information contained herein is subject to change without notice.

TEST CIRCUIT

1. I_{CEX}

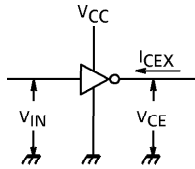

2. $V_{CE(sat)}$

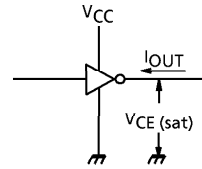

3. $I_{IN(ON)}$

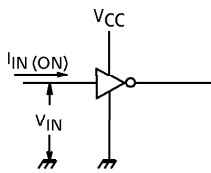

4. I_{CC}

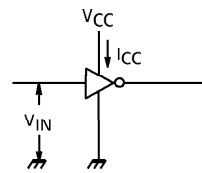

5. t_{ON}, t_{OFF}

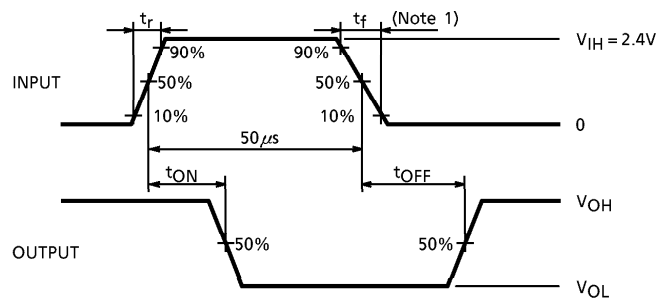
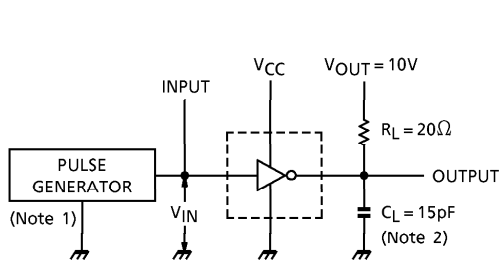

- (Note 1) Pulse Width $50\mu s$, Duty Cycle 10%
Output Impedance 50Ω , $t_r \leq 5ns$, $t_f \leq 10ns$
- (Note 2) C_L includes probe and jig capacitance.

PRECAUTIONS for USING

Utmost care is necessary in the design of the output line, V_{CC} and GND line since IC may be destroyed due to short-circuit between outputs, air contamination fault, or fault by improper grounding.

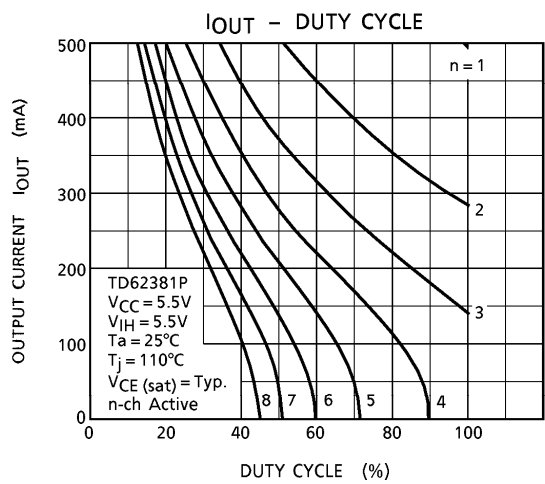
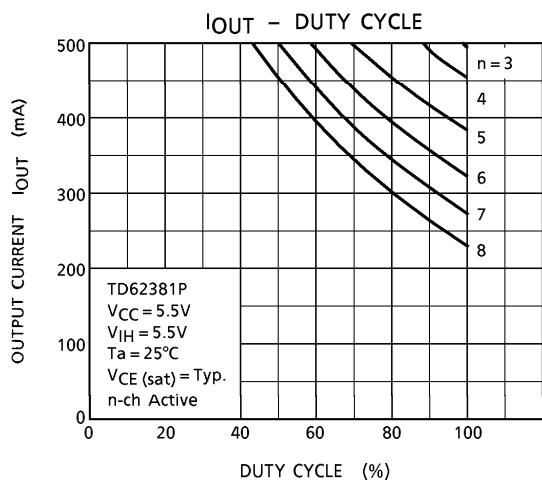
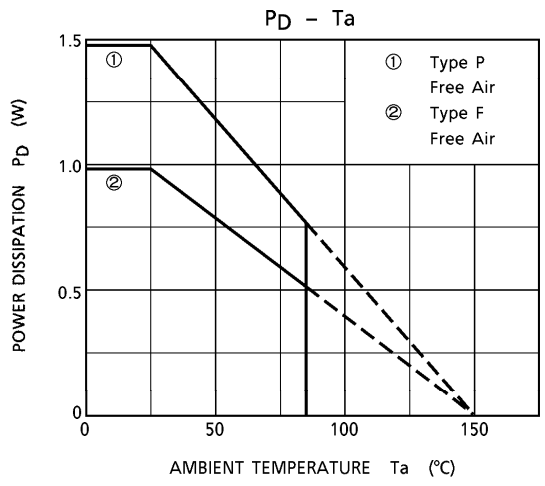
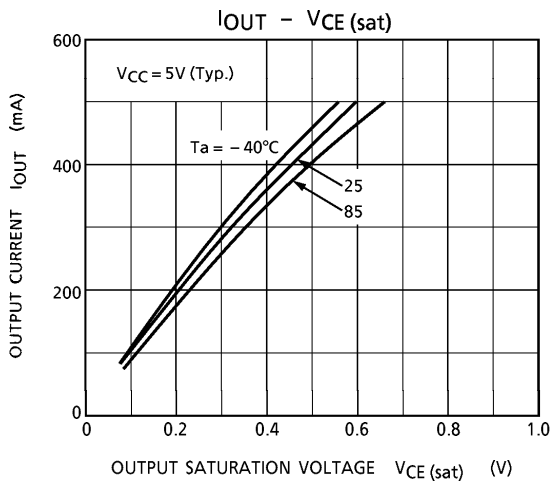
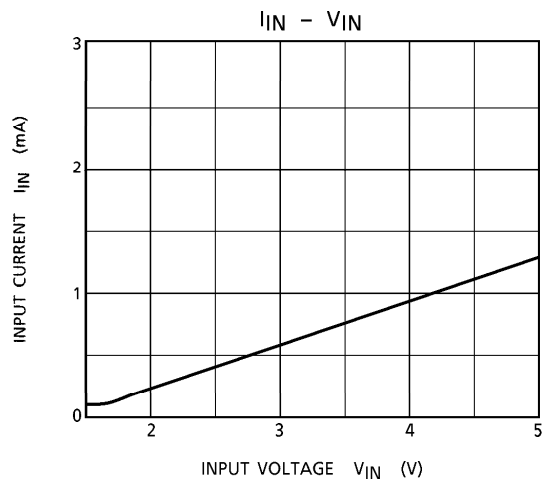
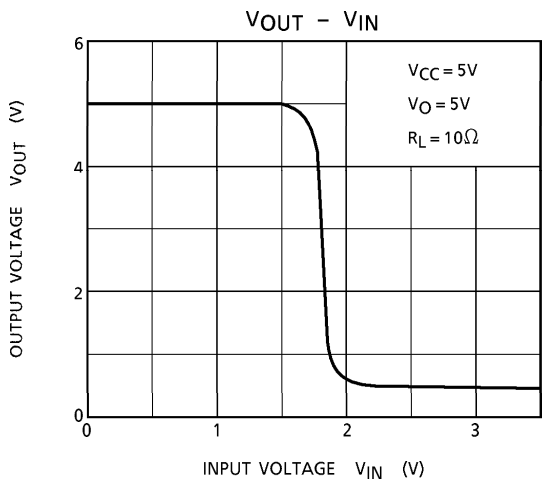

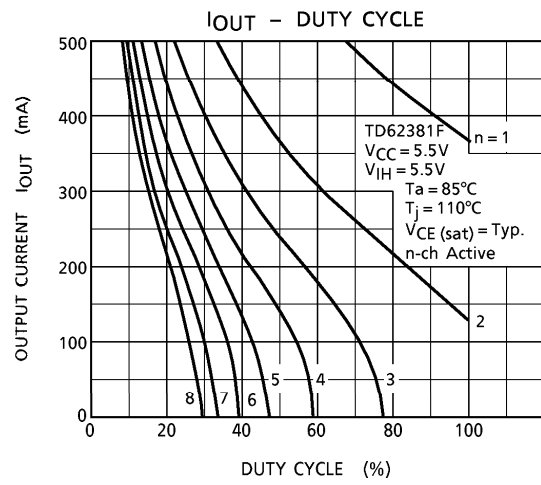
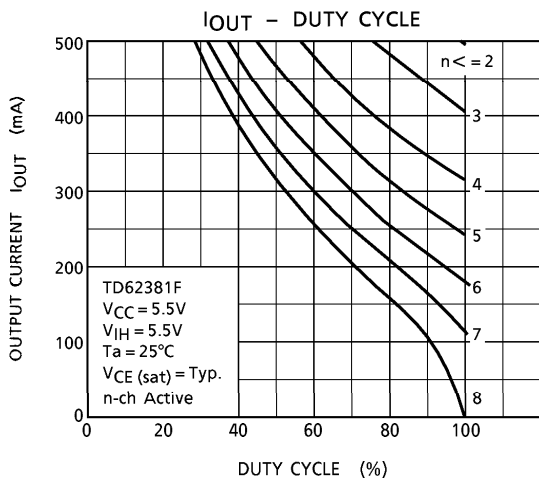

OUTLINE DRAWING
DIP18-P-300-2.54D

Unit : mm

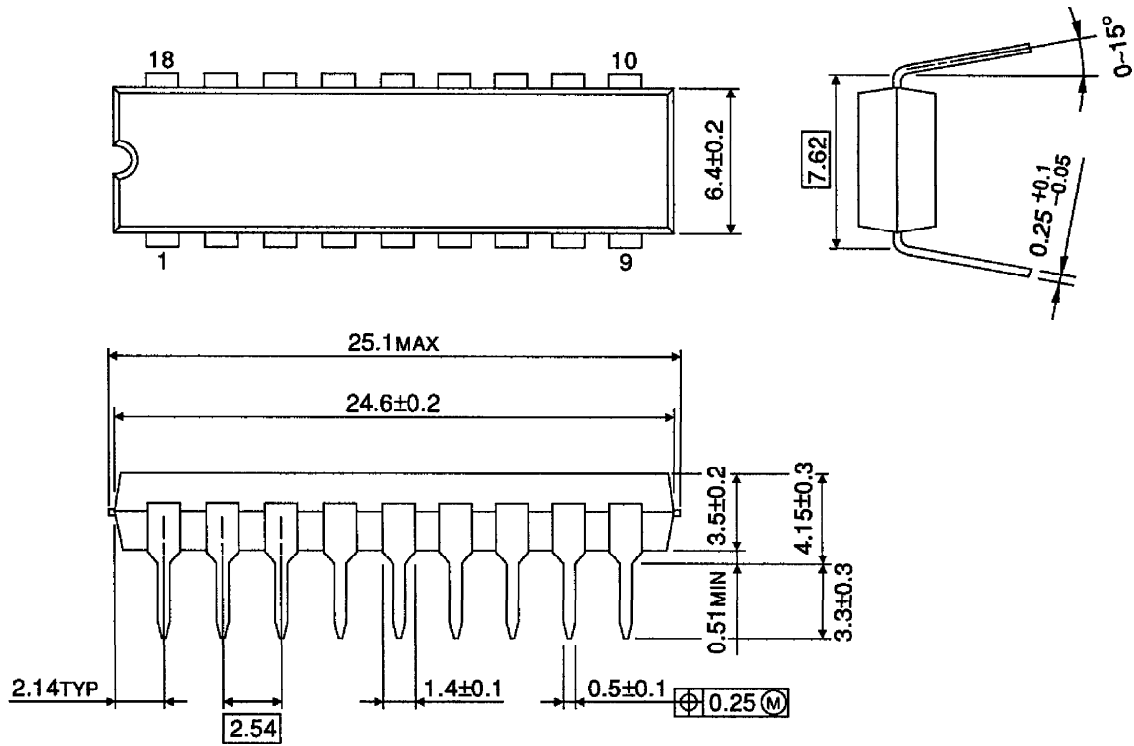

Weight : 1.47g (Typ.)

OUTLINE DRAWING
SOP18-P-375-1.27

Unit : mm

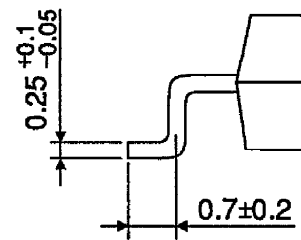
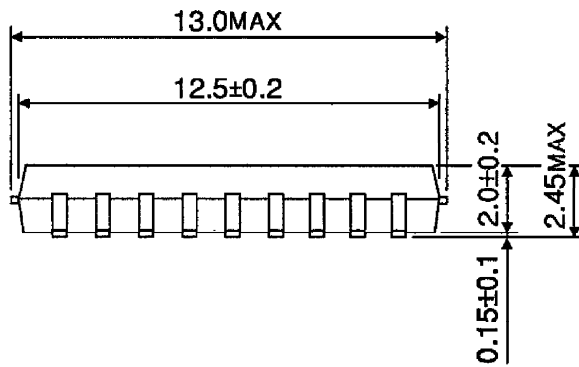
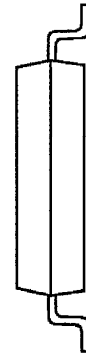
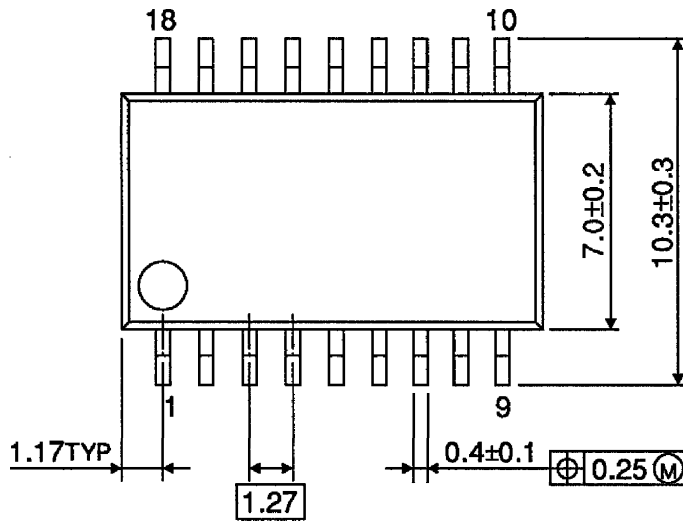

Weight : 0.41g (Typ.)