

**Features**

- Unity or + 2-gain bandwidth of 80 MHz
- 70 dB off-channel isolation at 4 MHz
- Directly drives high-impedance or 75Ω loads
- .02% and .02° differential gain and phase errors
- 8 ns switching time
- < 100 mV switching glitch
- 0.2% loaded gain error
- Compatible with ±3V to ±15V supplies
- 160 mW maximum dissipation at ±5V supplies

**Ordering Information**

Part No.	Temp. Range	Package	Outline
EL4421CN	-40°C to +85°C	8-Pin PDIP	MDP0031
EL4421CS	-40°C to +85°C	8-Pin SO	MDP0027
EL4422CN	-40°C to +85°C	8-Pin PDIP	MDP0031
EL4422CS	-40°C to +85°C	8-Pin SO	MDP0027
EL4441CN	-40°C to +85°C	14-Pin PDIP	MDP0031
EL4441CS	-40°C to +85°C	14-Pin SO	MDP0027
EL4442CN	-40°C to +85°C	14-Pin PDIP	MDP0031
EL4442CS	-40°C to +85°C	14-Pin SO	MDP0027
EL4443CN	-40°C to +85°C	14-Pin PDIP	MDP0031
EL4443CS	-40°C to +85°C	14-Pin SO	MDP0027
EL4444CN	-40°C to +85°C	14-Pin PDIP	MDP0031
EL4444CS	-40°C to +85°C	14-Pin SO	MDP0027

**General Description**

The EL44XX family of video multiplexed-amplifiers offers a very quick 8 ns switching time and low glitch along with very low video distortion. The amplifiers have good gain accuracy even when driving low-impedance loads. To save power, the amplifiers do not require heavy loading to remain stable.

The EL4421 and EL4422 are two-input multiplexed amplifiers. The -inputs of the input stages are wired together and the device can be used as a pin-compatible upgrade from the MAX453.

The EL4441 and EL4442 have four inputs, also with common feedback. These may be used as upgrades of the MAX454.

The EL4443 and EL4444 are also 4-input multiplexed amplifiers, but both positive and negative inputs are wired separately. A wide variety of gain- and phase-switching circuits can be built using independent feedback paths for each channel.

The EL4421, EL4441, and EL4443 are internally compensated for unity-gain operation. The EL4422, EL4442, and EL4444 are compensated for gains of + 2 or more, especially useful for driving back-matched cables.

The amplifiers have an operational temperature of -40°C to +85°C and are packaged in plastic 8- and 14-pin DIP and 8- and 14-pin SO.

The EL44XX multiplexed-amplifier family is fabricated with Elantec's proprietary complementary bipolar process which gives excellent signal symmetry and is very rugged.

**Connection Diagrams**

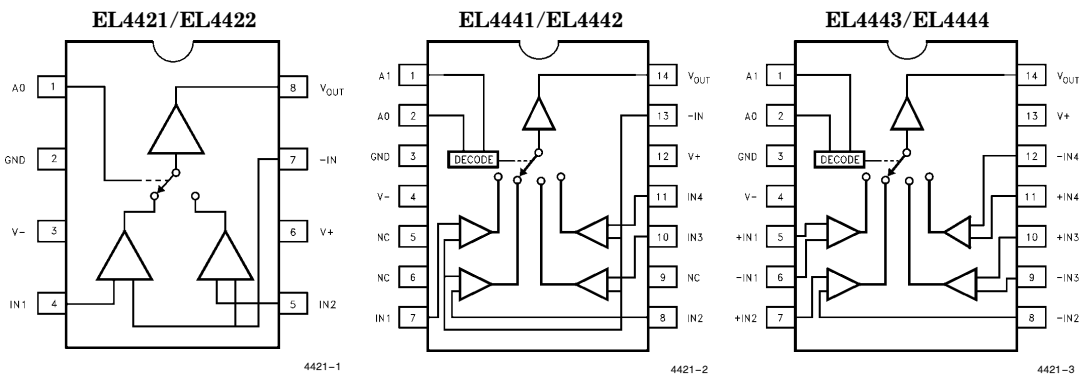

Manufactured under U.S. Patent No. 5,352,987

Note: All information contained in this data sheet has been carefully checked and is believed to be accurate as of the date of publication; however, this data sheet cannot be a "controlled document". Current revisions, if any, to these specifications are maintained at the factory and are available upon your request. We recommend checking the revision level before finalization of your design documentation.

# EL4421C/22C/41C/42C/43C/44C

## Multiplexed-Input Video Amplifiers

### Absolute Maximum Ratings

V+	Positive Supply Voltage	16.5V	V <sub>LOGIC</sub>	Voltage at A0 or A1	-4V to 6V
V <sub>S</sub>	V+ to V- Supply Voltage	33V	I <sub>IN</sub>	Current into any Input, Feedback, or Logic Pin	4 mA
V <sub>IN</sub>	Voltage at any Input or Feedback	V+ to V-	I <sub>OUT</sub>	Output Current	30 mA
ΔV <sub>IN</sub>	Difference between Pairs of Inputs or Feedback	6V	P <sub>D</sub>	Maximum Power Dissipation	See Curves

#### Important Note:

All parameters having Min/Max specifications are guaranteed. The Test Level column indicates the specific device testing actually performed during production and Quality inspection. Elantec performs most electrical tests using modern high-speed automatic test equipment, specifically the LTX77 Series system. Unless otherwise noted, all tests are pulsed tests, therefore T<sub>J</sub> = T<sub>C</sub> = T<sub>A</sub>.

Test Level	Test Procedure
I	100% production tested and QA sample tested per QA test plan QCX0002.
II	100% production tested at T <sub>A</sub> = 25°C and QA sample tested at T <sub>A</sub> = 25°C, T <sub>MAX</sub> and T <sub>MIN</sub> per QA test plan QCX0002.
III	QA sample tested per QA test plan QCX0002.
IV	Parameter is guaranteed (but not tested) by Design and Characterization Data.
V	Parameter is typical value at T <sub>A</sub> = 25°C for information purposes only.

### Open-Loop DC Electrical Characteristics

Power supplies at ±5V, T<sub>A</sub> = 25°C, R<sub>L</sub> = 500Ω, unless otherwise specified

Parameter	Description	Min	Typ	Max	Test Level	Units
V <sub>OS</sub>	Input Offset Voltage '21, '41, and '43 '22, '42, and '44	-9 -7	±3 ±2	9 7	I I	mV
I <sub>B</sub>	Input Bias Current, Positive Inputs Only of the '21, '22, '41, '42, and All Inputs of the '43 and '44	-12	-5	0	I	μA
I <sub>FB</sub>	Input Bias Currents of Common Feedback - '21 and '22 - '41 and '42	-24 -48	-10 -20	0 0	I I	μA
I <sub>OS</sub>	Input Offset Currents of the '43 and '44		60	350	I	nA
E <sub>G</sub>	Gain Error of the '21 and '41 and '43 (Note 1) '22, '42 and '44		0.2 0.1	0.6 0.6	I I	% V/V
A <sub>VOL</sub>	Open-Loop Gain EL4443 (Note 1) EL4444	350 500	500 750		I I	V/V V/V
V <sub>IN</sub>	Input Signal Range, EL4421 and EL4441 (Note 2)	±2.5	±3		I	V
CMRR	Common-Mode Rejection Ratio, EL4443 and EL4444	70	90		I	dB
PSRR	Power Supply Rejection Ratio V <sub>s</sub> from ±5V to ±15V	60	70		I	dB

# EL4421C/22C/41C/42C/43C/44C

## Multiplexed-Input Video Amplifiers

### Open-Loop DC Electrical Characteristics — Contd.

Power supplies at  $\pm 5V$ ,  $T_A = 25^\circ C$

Parameter	Description	Min	Typ	Max	Test Level	Units
CMIR	Common-Mode Input Range (Note 3) EL4443 and EL4444	$\pm 2.5$	$\pm 3$		I	V
$V_{OUT}$	Output Swing	$\pm 2.5$	$\pm 3.5$		I	V
$I_{SC}$	Output Short-Circuit Current	$\pm 40$	$\pm 80$		I	mA
$F_T$	Unselected Channel Feedthrough '21, '41, '43 Attenuation, (Note 1) '22, '42, '44	70	80		I	dB
		55	64		I	dB
$I_{LOGIC}$	Input Current at A0 and A1 with Input = 0V and 5V	-16	-8	0	I	$\mu A$
$V_{LOGIC}$	Logic Valid High and Low Input Levels	0.8		2.0	I	V
$I_S$	Supply Current EL4421 and EL4422 EL4441, EL4442, EL4443, and EL4444		11	14	I	mA
			13	16		

Note 1: The '21, '41, and '43 devices are connected for unity-gain operation with 75 $\Omega$  load and an input span of  $\pm 1V$ . The '22, '42, and '44 devices are connected for a gain of +2 with a 150 $\Omega$  load and a  $\pm 1V$  input span with  $R_F = R_G = 270\Omega$ .

Note 2: The '21 and '41 devices are connected for unity gain with a  $\pm 3V$  input span while the output swing is measured.

Note 3: CMIR is assured by passing the CMRR test at input voltage extremes.

### Closed-Loop AC Electrical Characteristics

Power supplies at  $\pm 5V$ ,  $T_A = 25^\circ C$ , for EL4421, EL4441, and EL4443  $A_V = +1$  and  $R_L = 500\Omega$ , for EL4422, EL4442, and EL4444  $A_V = +2$  and  $R_L = 150\Omega$  with  $R_F = R_G = 270\Omega$  and  $C_F = 3 pF$ ; for all  $C_L = 15 pF$

Parameter	Description	Min	Typ	Max	Test Level	Units
BW - 3 dB	- 3 dB Small-Signal Bandwidth, EL4421, '41, '43 EL4422, '42, '44		80		V	MHz
			65		V	MHz
BW $\pm 0.1$ dB	0.1 dB Flatness Bandwidth		10		V	MHz
Peaking	Frequency Response Peaking		0.5		V	dB
SR	Slewrate, $V_{OUT}$ between -2.5V and +2.5V, $V_S = \pm 12V$ EL4421, EL4441, EL4443 EL4422, EL4442, EL4444	150	200		I	V/ $\mu$ sec
		180	240		I	V/ $\mu$ sec
$V_n$	Input-Referred Noise Voltage Density EL4421, EL4441, EL4443 EL4422, EL4442, EL4444		18		V	nV/rt-hz
			14		V	nV/rt-hz
$d_G$	Differential Gain Error, $V_{OFFSET}$ between -0.7V and +0.7V EL4421, EL4441, EL4443 ( $V_S = \pm 12V$ ) EL4421, EL4441, EL4443 ( $V_S = \pm 5V$ ) EL4422, EL4442, EL4444 ( $V_S = \pm 12V$ ) EL4422, EL4442, EL4444 ( $V_S = \pm 5V$ )		0.01		V	%
			0.10		V	%
			0.02		V	%
			0.11		V	%

# EL4421C/22C/41C/42C/43C/44C

## Multiplexed-Input Video Amplifiers

### Closed-Loop AC Electrical Characteristics

Power supplies at  $\pm 5V$ .  $T_A = 25^\circ C$ , for EL4421, EL4441, and EL4443  $A_V = +1$  and  $R_L = 500\Omega$ , for EL4422, EL4442, and EL4444  $A_V = +2$  and  $R_L = 150\Omega$  with  $R_F = R_G = 270\Omega$  and  $C_F = 3\text{ pF}$ ; for all  $C_L = 15\text{ pF}$  — Contd.

Parameter	Description	Min	Typ	Max	Test Level	Units
$d\phi$	Differential Phase Error, $V_{OFFSET}$ between $-0.7V$ and $+0.7V$ EL4421, EL4441, EL4443 ( $V_S = \pm 12V$ ) EL4421, EL4441, EL4443 ( $V_S = \pm 5V$ ) EL4422, EL4442, EL4444 ( $V_S = \pm 12V$ ) EL4422, EL4442, EL4444 ( $V_S = \pm 5V$ )		0.01 0.1 0.02 0.15		V V V V	$^\circ$ $^\circ$ $^\circ$ $^\circ$
$T_{MUX}$	Multiplex Delay Time, Logic Threshold to 50% Signal Change EL4421, '22 EL4441, '42, '43, '44		8 12		V V	nsec nsec
$V_{GLITCH}$	Peak Multiplex Glitch EL4421, '22 EL4441, '42, '43, '44		70 100		V V	mV mV
ISO	Channel Off Isolation at 3.58 MHz (See Text) EL4421, EL4441, EL4443 EL4422, EL4442, EL4444		76 63		V V	dB dB

### Typical Performance Curves

EL4421, EL4441, and EL4443  
Small-Signal Transient Response  
 $V_S = \pm 5V$ ,  $R_L = 500\Omega$

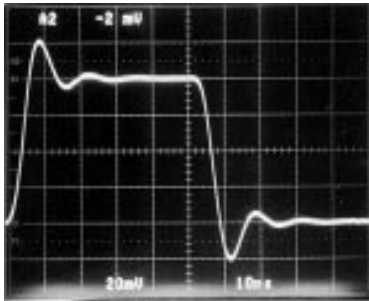

4421-5

EL4421, EL4441, and EL4443  
Large-Signal Response  
 $V_S = \pm 12V$ ,  $R_L = 500\Omega$

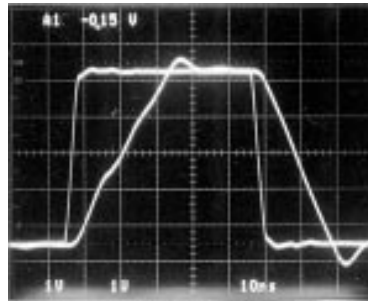

4421-6

EL4421, EL4441, and EL4443  
Frequency Response for Various Gains

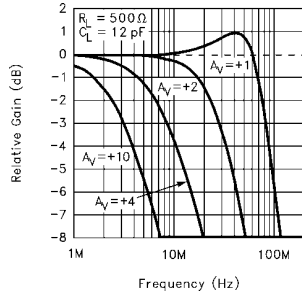

4421-7

EL4422, EL4442, and EL4444  
Frequency Response for Various Gains

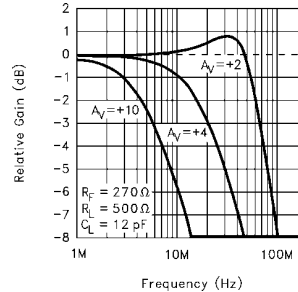

4421-8

# EL4421C/22C/41C/42C/43C/44C

## Multiplexed-Input Video Amplifiers

### Typical Performance Curves — Contd.

**EL4421, EL4441, and EL4443**  
Frequency Response for Various Loads  
 $V_S = \pm 5V, A_V = +1$

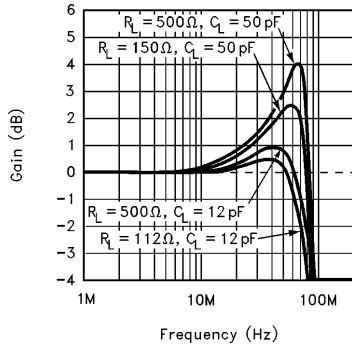

4421-9

**EL4422, EL4442, and EL4444**  
Frequency Response for Various Loads  
 $V_S = \pm 5V, A_V = +2$

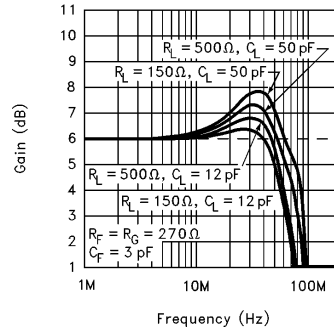

4421-10

**Frequency Response for Various Loads**  
 $V_S = \pm 15V, A_V = +1$

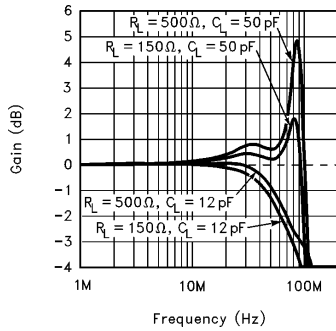

4421-11

**EL4422, EL4442, and EL4444**  
Frequency Response for Various Loads  
 $V_S = \pm 15V, A_V = +2$

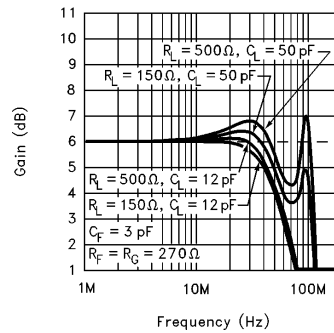

4421-12

**EL4443 Open-Loop Gain and Phase vs Frequency**

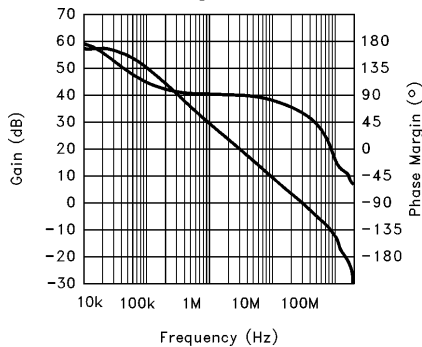

4421-13

**EL4444 Open-Loop Gain and Phase vs Frequency**

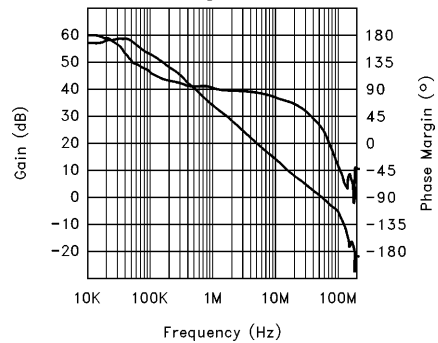

4421-37

# EL4421C/22C/41C/42C/43C/44C

## Multiplexed-Input Video Amplifiers

### Typical Performance Curves — Contd.

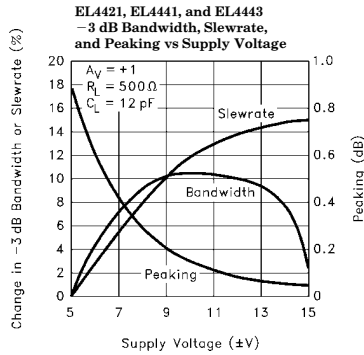

4421-14

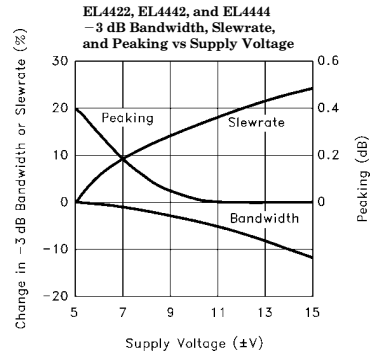

4421-15

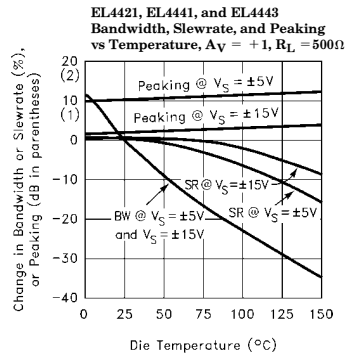

4421-16

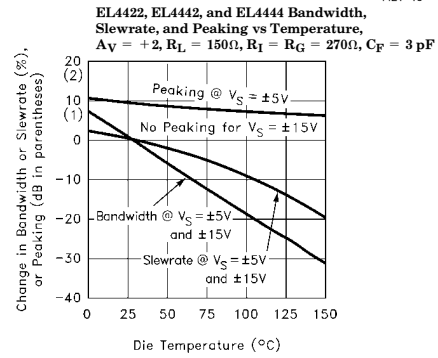

4421-17

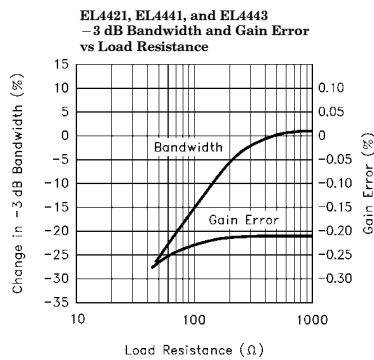

4421-18

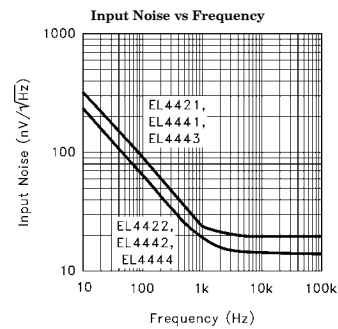

4421-19

# EL4421C/22C/41C/42C/43C/44C

## Multiplexed-Input Video Amplifiers

### Typical Performance Curves — Contd.

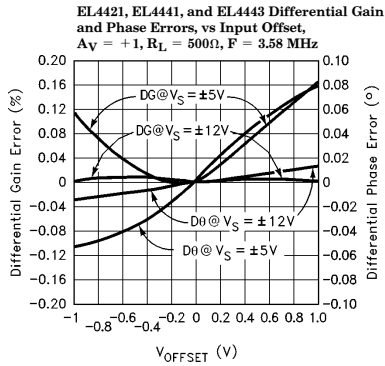

4421-20

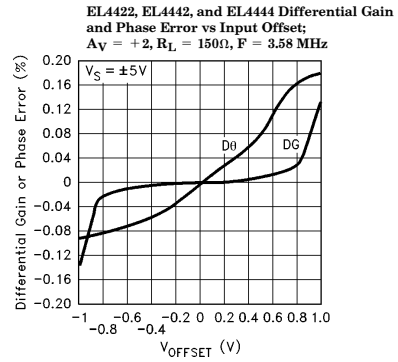

4421-21

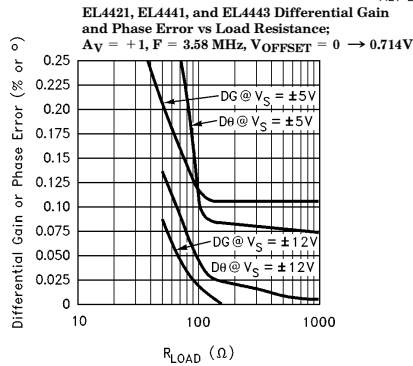

4421-22

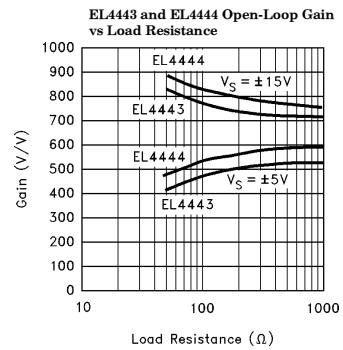

4421-23

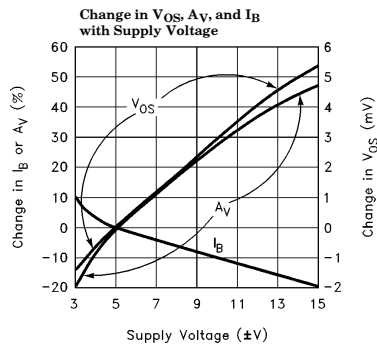

4421-24

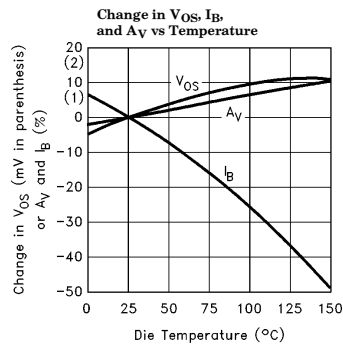

4421-25

# EL4421C/22C/41C/42C/43C/44C

## Multiplexed-Input Video Amplifiers

### Typical Performance Curves — Contd.

Switching Waveforms  
Switching from Grounded Input  
to Uncorrelated Sinewave and Back

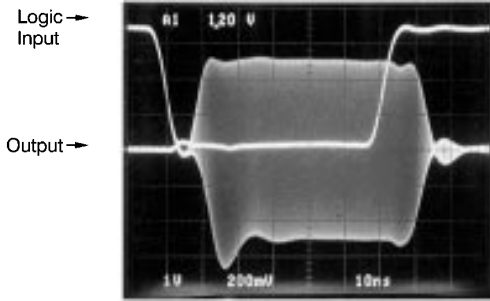

4421-26

Channel-to-Channel  
Switching Glitch

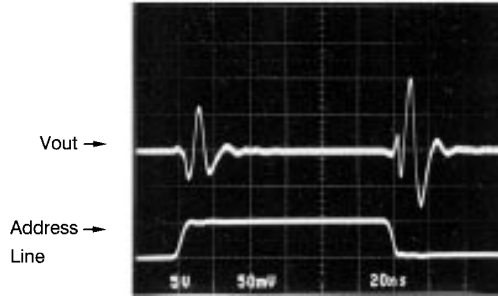

4421-27

EL4421, EL4441, and EL4443  
Unselected Channel  
Feedthrough vs Frequency

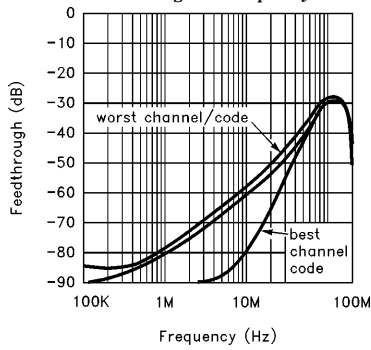

4421-28

EL4422, EL4442, and EL4444  
Unselected Channel  
Feedthrough vs Frequency

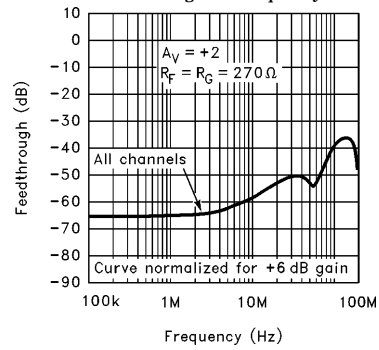

4421-29

EL4443 and EL4444  
Input and Output Range vs  
Supply Voltage (Output Unloaded)

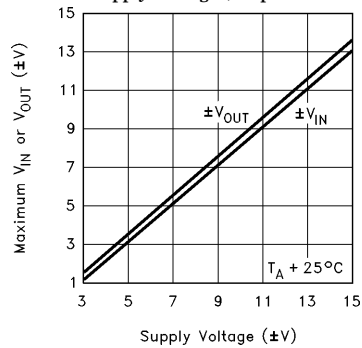

4421-30



# EL4421C/22C/41C/42C/43C/44C

## Multiplexed-Input Video Amplifiers

### Typical Performance Curves — Contd.

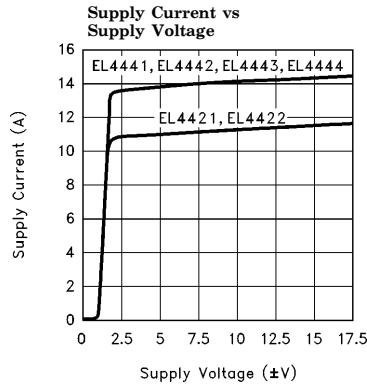

4421-31

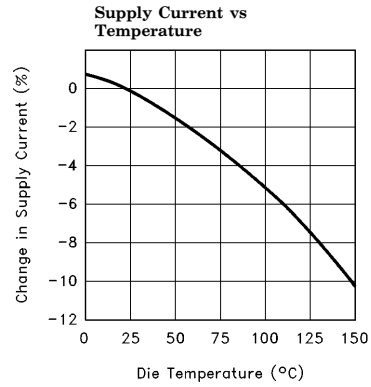

4421-32

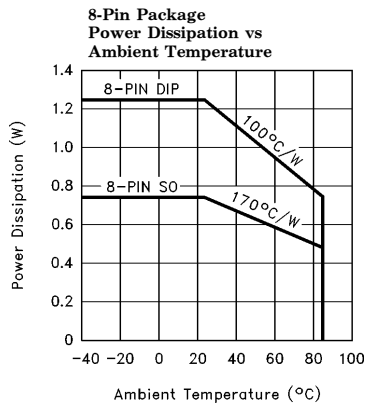

4421-33

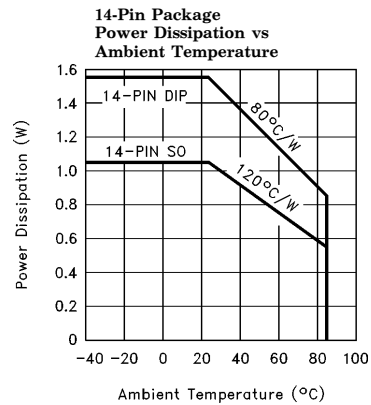

4421-34

### Applications Information

#### General Description

The EL44XX family of video mux-amps are composed of two or four input stages whose inputs are selected and control an output stage. One of the inputs is active at a time and the circuit behaves as a traditional voltage-feedback op-amp for that input, rejecting signals present at the unselected inputs. Selection is controlled by one or two logic inputs.

The EL4421, EL4422, EL4441, and EL4442 have all  $-$ inputs wired in parallel, allowing a single feedback network to set the gain of all inputs. These devices are wired for positive gains. The

EL4443 and EL4444, on the other hand, have all  $+$ inputs and  $-$ inputs brought out separately so that the input stage can be wired for independent gains and gain polarities with separate feedback networks.

The EL4421, EL4441, and EL4443 are compensated for unity-gain stability, while the EL4422, EL4442, and EL4444 are compensated for a feedback gain of  $+2$ , ideal for driving back-terminated cables or maintaining bandwidth at higher feedback gains.

# EL4421C/22C/41C/42C/43C/44C

## Multiplexed-Input Video Amplifiers

### Applications Information — Contd.

#### Switching Characteristics

The logic inputs work with standard TTL levels of 0.8V or less for a logic 0 and 2.0V or more for a logic 1, making them compatible for TTL and

CMOS drivers. The ground pin is the logic threshold biasing reference. The simplified input circuitry is shown below:

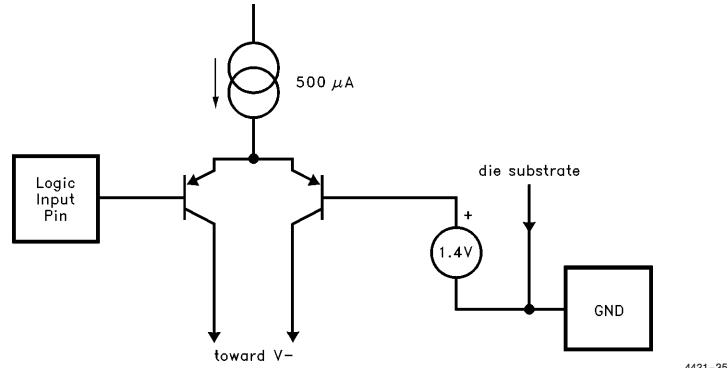

Figure 1. Simplified Logic Input Circuitry

The ground pin draws a maximum DC current of 6  $\mu$ A, and may be biased anywhere between  $(V^-) + 2.5V$  and  $(V^+) - 3.5V$ . The logic inputs may range from  $(V^-) + 2.5V$  to  $V^+$ , and are additionally required to be no more negative than

$V(\text{Gnd pin}) - 4V$  and no more positive than  $V(\text{Gnd pin}) + 6V$ .

For example, within these constraints, we can power the EL44XX's from +5V and +12V without a negative supply by using these connections:

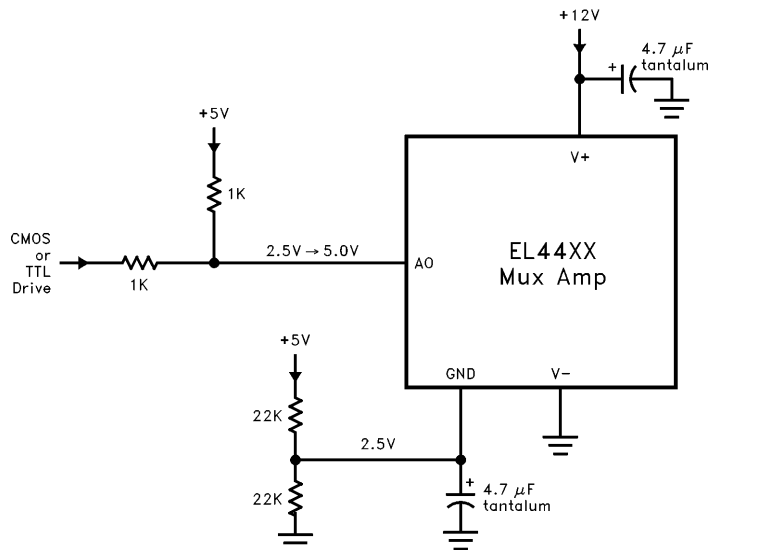

Figure 2. Using the EL44XX Mux Amps with +5V and +12V Supplies

## *EL4421C/22C/41C/42C/43C/44C* *Multiplexed-Input Video Amplifiers*

### **Applications Information** — Contd.

The logic input(s) and ground pin are shifted 2.5V above system ground to correctly bias the mux-amp. Of course, all the signal inputs and output will have to be shifted 2.5V above system ground to ensure proper signal path biasing.

A final caution: the ground pin is also connected to the IC's substrate and frequency compensation components. The ground pin must be returned to system ground by a short wire or nearby bypass capacitor. In figure 2, the 22 K $\Omega$  resistors also serve to isolate the bypassed ground pin from the +5V supply noise.

### **Signal Amplitudes**

Signal input and output voltages must be between  $(V-)+2.5V$  and  $(V+)-2.5V$  to ensure linearity. Additionally, the differential voltage on any input stage must be limited to  $\pm 6V$  to prevent damage. In unity-gain connections, any input could have  $\pm 3V$  applied and the output would be at  $\pm 3V$ , putting us at our 6V differential limit. Higher-gain circuit applications divide the output voltage and allow for larger outputs. For instance, at a gain of +2 the maximum input

is again  $\pm 3V$  and the output swing is  $\pm 6V$ . The EL4443 or EL4444 can be wired for inverting gain with even more amplitude possible.

The output and positive inputs respond to overloading amplitudes correctly; that is, they simply clamp and remain monotonic with increasing +input overdrive. A condition exists, however, where the -input of an active stage is overdriven by large outputs. This occurs mainly in unity-gain connections, and only happens for negative inputs. The overloaded input cannot control the feedback loop correctly and the output can become non-monotonic. A typical scenario has the circuit running on  $\pm 5V$  supplies, connected for unity gain, and the input is the maximum  $\pm 3V$ . Negative input extremes can cause the output to jump from  $-3V$  to around  $-2.3V$ . This will never happen if the input is restricted to  $\pm 2.5V$ , which is the guaranteed maximum input compliance with  $\pm 5V$  supplies, and is not a problem with greater supply voltages. Connecting the feedback network with a divider will prevent the overloaded output voltage from being large enough to overload the -input and monotonic

# EL4421C/22C/41C/42C/43C/44C

## Multiplexed-Input Video Amplifiers

### Applications Information — Contd.

behavior is assured. In any event, keeping signals within guaranteed compliance limits will assure freedom from overload problems.

The input and output ranges are substantially constant with temperature.

### Power Supplies

The mux-amps work well on any supplies from  $\pm 3\text{V}$  to  $\pm 15\text{V}$ . The supplies may be of different voltages as long as the requirements of the Gnd pin are observed (see the Switching Characteristics section for a discussion). The supplies should be bypassed close to the device with short leads.  $4.7\ \mu\text{F}$  tantalum capacitors are very good, and no smaller bypasses need be placed in parallel. Capacitors as small as  $0.01\ \mu\text{F}$  can be used if small load currents flow.

Single-polarity supplies, such as  $+12\text{V}$  with  $+5\text{V}$  can be used as described in the Switching Characteristics section. The inputs and outputs will have to have their levels shifted above ground to accommodate the lack of negative supply.

The dissipation of the mux-amps increases with power supply voltage, and this must be compatible with the package chosen. This is a close estimate for the dissipation of a circuit:

$$P_D = 2V_S \times I_{s,\text{max}} + (V_S - V_O) \times V_O / R_{\text{PAR}}$$

Where  $I_{s,\text{max}}$  is the maximum supply current

$V_S$  is the  $\pm$  supply voltage (assumed equal)

$V_O$  if the output voltage

$R_{\text{PAR}}$  is the parallel of all resistors loading the output

For instance, the EL4422 draws a maximum of  $14\ \text{mA}$  and we might require a  $2\text{V}$  peak output into  $150\ \Omega$  and a  $270\ \Omega + 270\ \Omega$  feedback divider. The  $R_{\text{PAR}}$  is  $117\ \Omega$ . The dissipation with  $\pm 5\text{V}$  supplies is  $191\ \text{mW}$ . The maximum Supply voltage that the device can run on for a given  $P_D$  and the other parameter is

$$V_{S,\text{max}} = (P_D + V_O^2 / R_{\text{PAR}}) / 2I_s + V_O / R_{\text{PAR}}$$

The maximum dissipation a package support is

$$P_{D,\text{max}} = (T_{D,\text{max}} - T_{A,\text{max}}) / R_{\text{TH}}$$

Where  $T_{D,\text{max}}$  is the maximum die temperature,  $150^\circ\text{C}$  for reliability, less to retain optimum electrical performance

$T_{A,\text{max}}$  is the ambient temperature,  $70^\circ$  for commercial and  $85^\circ\text{C}$  for industrial range

$R_{\text{TH}}$  is the thermal resistance of the mounted package, obtained from data sheet dissipation curves

The most difficult case is the SO-8 package. With a maximum die temperature of  $150^\circ\text{C}$  and a maximum ambient temperature of  $85^\circ$ , the  $65^\circ$  temperature rise and package thermal resistance of  $170^\circ/\text{W}$  gives a maximum dissipation of  $382\ \text{mW}$ . This allows a maximum supply voltage of  $\pm 9.2\text{V}$  for the EL4422 operated in our example. If the EL4421 were driving a light load ( $R_{\text{PAR}} \rightarrow \infty$ ), it could operate on  $\pm 15\text{V}$  supplies at a  $70^\circ$  maximum ambient.

The EL4441 through EL4444 can operate on  $\pm 12\text{V}$  supplies in the SO package, and all parts can be powered by  $\pm 15\text{V}$  supplies in DIP packages.

### Output Loading

The output stage of the mux-amp is very powerful, and can source  $80\ \text{mA}$  and sink  $120\ \text{mA}$ . Of course, this is too much current to sustain and the part will eventually be destroyed by excessive dissipation or by metal traces on the die opening. The metal traces are completely reliable while delivering the  $30\ \text{mA}$  continuous output given in the Absolute Maximum Ratings table in this data sheet, or higher purely transient currents.

Gain or gain accuracy degrades only  $10\%$  from no load to  $100\ \Omega$  load. Heavy resistive loading will degrade frequency response and video distortion only a bit, becoming noticeably worse for loads  $< 100\ \Omega$ .

## *EL4421C/22C/41C/42C/43C/44C*

### *Multiplexed-Input Video Amplifiers*

#### Applications Information — Contd.

Capacitive loads will cause peaking in the frequency response. If capacitive loads must be driven, a small-valued series resistor can be used to isolate it.  $12\Omega$  to  $51\Omega$  should suffice. A  $22\Omega$  series resistor will limit peaking to 2.5 dB with even a 220 pF load.

#### Input Connections

The input transistors can be driven from resistive and capacitive sources but are capable of oscillation when presented with an inductive input. It takes about 80 nH of series inductance to make the inputs actually oscillate, equivalent to four inches of unshielded wiring or about 6" of unterminated input transmission line. The oscillation has a characteristic frequency of 500 MHz.

Often simply placing one's finger (via a metal probe) or an oscilloscope probe on the input will kill the oscillation. Normal high-frequency construction obviates any such problems, where the input source is reasonably close to the mux-amp input. If this is not possible, one can insert series resistors of around  $51\Omega$  to de-Q the inputs.

#### Feedback Connections

A feedback divider is used to increase circuit gain, and some precautions should be observed. The first is that parasitic capacitance at the  $-$  input will add phase lag to the feedback path and increase frequency response peaking or even cause oscillation. One solution is to choose feedback resistors whose parallel value is low. The pole frequency of the feedback network should be maintained above at least 200 MHz. For a 3 pF parasitic, this requires that the feedback divider have less than  $265\Omega$  impedance, equivalent to two  $510\Omega$  resistors when a gain of +2 is desired. Alternatively, a small capacitor across  $R_F$  can be used to create more of a frequency-compensated divider. The value of the capacitor should match the parasitic capacitance at the  $-$  input. It is also practical to place small capacitors across both the feedback resistors (whose values maintain the desired gain) to swamp out parasitics. For instance, two 10 pF capacitors across equal divider resistors will dominate parasitic effects and allow a higher divider resistance.

The other major concern about the divider concerns unselected-channel crosstalk. The differential input impedance of each input stage is around 200 K $\Omega$ . The unselected input's signal sources thus drive current through that input impedance into the feedback divider, inducing an unwanted output. The gain from unselected input to output, the crosstalk attenuation, is  $R_F/R_{IN}$ . In unity-gain connection the feedback resistor is  $0\Omega$  and very little crosstalk is induced. For a gain of +2, the crosstalk is about  $-60$  dB.

#### Feedthrough Attenuation

The channels have different crosstalk levels with different inputs. Here is the typical attenuation for all combinations of inputs for the mux-amps at 3.58 MHz:

Feedthrough of EL4441 and EL4443 at 3.58 MHz

	In1	In2	In3	In4
Select Inputs, A1A0	00 Selected	$-77$ dB	$-90$ dB	$-92$ dB
	01	$-80$ dB	Selected	$-90$ dB
	10	$-101$ dB	$-76$ dB	Selected
	11	$-96$ dB	$-84$ dB	$-66$ dB
				Selected

Feedthrough of EL4421 at 3.58 MHz

	In1	In2
Channel Select Input, A0	0 Selected	$-88$ dB
	1	$-93$ dB
		Selected

#### Switching Glitches

The output of the mux-amps produces a small "glitch" voltage in response to a logic input change. A peak amplitude of only about 90 mV occurs, and the transient settles out in 20 ns. The glitch does not change amplitude with different gain settings.

With the four-input multiplexers, when two logic inputs are simultaneously changed, the glitch amplitude doubles. The increase can be avoided by keeping transitions at least 6 ns apart. This can be accomplished by inserting one gate delay in one of the two logic inputs when they are truly synchronous.

**BLANK**

**BLANK**

## ***EL4421C/22C/41C/42C/43C/44C*** ***Multiplexed-Input Video Amplifiers***

### **General Disclaimer**

Specifications contained in this data sheet are in effect as of the publication date shown. Elantec, Inc. reserves the right to make changes in the circuitry or specifications contained herein at any time without notice. Elantec, Inc. assumes no responsibility for the use of any circuits described herein and makes no representations that they are free from patent infringement.

***élantec***  
HIGH PERFORMANCE ANALOG INTEGRATED CIRCUITS

### **Elantec, Inc.**

1996 Tarob Court

Milpitas, CA 95035

Telephone: (408) 945-1323

(800) 333-6314

Fax: (408) 945-9305

European Office: 44-71-482-4596

### **WARNING — Life Support Policy**

Elantec, Inc. products are not authorized for and should not be used within Life Support Systems without the specific written consent of Elantec, Inc. Life Support systems are equipment intended to support or sustain life and whose failure to perform when properly used in accordance with instructions provided can be reasonably expected to result in significant personal injury or death. Users contemplating application of Elantec, Inc. products in Life Support Systems are requested to contact Elantec, Inc. factory headquarters to establish suitable terms & conditions for these applications. Elantec, Inc.'s warranty is limited to replacement of defective components and does not cover injury to persons or property or other consequential damages.