

POWER FACTOR CONTROLLER

■ GENERAL DESCRIPTION

The NJM2375/A are active power factor controllers, which limit the harmonic current resulting from the power supply block of electrical devices.

They include a startup timer, an one quadrant multiplier, a zero current detector to ensure critical condition operation, a transconductance error amplifier, high precision reference, a current sensing comparator, and a totem pole output ideally suited for driving a power MOSFET.

They also contain protection circuits for overvoltage, cycle-by-cycle overcurrent, and maximum peak current.

The startup threshold of NJM2375A is lower than that of NJM2375.

■ FEATURES

- Overvoltage Comparator Eliminates Runaway Output Voltage
- Internal Quick Start
- Internal Startup Timer
- One Quadrant Multiplier
- Zero Current Detector
- High Precision Reference ($\pm 2\%$)
- Totem Pole Output with High State Clamp
- Undervoltage Lockout
(Startup Threshold/NJM2375:13V typ., NJM2375A:10.4V typ.)
- Low Startup and Operating Current
- Bipolar Technology
- Package Outline DIP8, DMP8, SSOP14, SIP8

■ PACKAGE OUTLINE

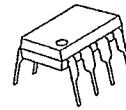

NJM2375D/AD



NJM2375M/AM



NJM2375V/AV

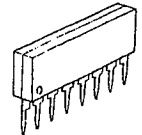

NJM2375L/AL

■ PIN CONFIGURATION

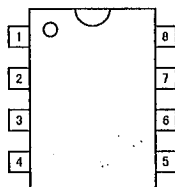

NJM2375D/AD
NJM2375M/AM

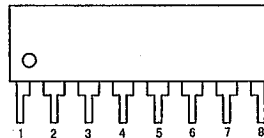

NJM2375L/AL

PIN FUNCTION

1. V_{FB}
2. COMP
3. MULT
4. C_{SENCE}
5. D_{ZERO}
6. GND
7. DRIVE
8. V^+

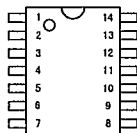

NJM2375V/AV

PIN FUNCTION

- | | |
|----------------|--------------|
| 1. MULT | 8. DRIVE |
| 2. NC | 9. NC |
| 3. C_{SENCE} | 10. V^+ |
| 4. NC | 11. NC |
| 5. D_{ZERO} | 12. V_{FB} |
| 6. NC | 13. NC |
| 7. GND | 14. COMP |

6

■ BLOCK DIAGRAM

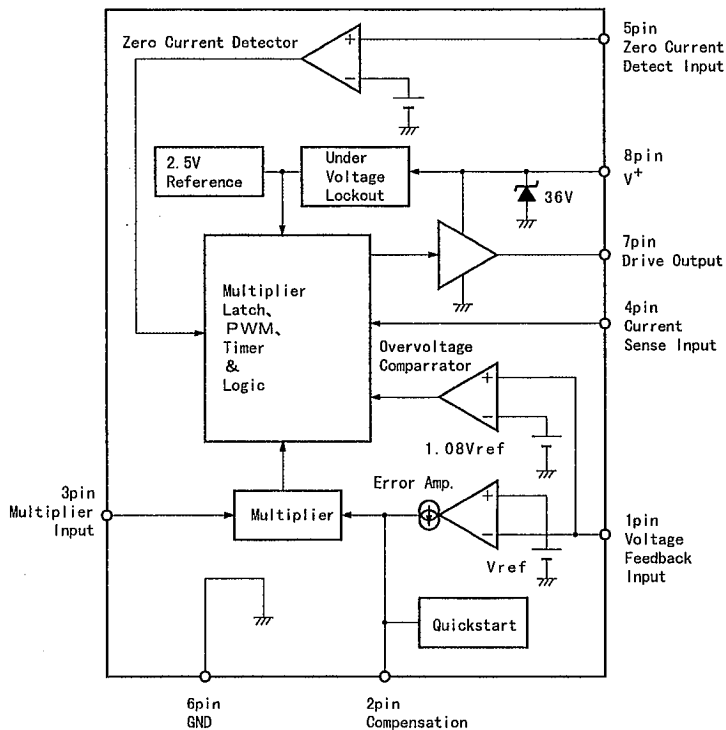

■ ABSOLUTE MAXIMUM RATINGS (Ta=25°C)

PARAMETER	SYMBOL	RATINGS	UNIT
Total Power Supply and Zener Current	$I_{CC} + I_Z$	30	mA
Output Current (Source or Sink)	I_O	500	mA
Current Sense, Multiplier, and Voltage Feedback Inputs	V_{IN}	-1.0~+10	V
Zero Current Detect Input High State Forward Current Low state Forward Current	I_{IN}	50 -10	mA
Power Dissipation	P_D	(DIP8) 500 (DMP8) 300 (SSOP14) 300 (SIP8) 700	mW
Operating Temperature Range	T_{OPR}	-40~+85	°C
Storage Temperature Range	T_{STG}	-50~+150	°C

■ ELECTRICAL CHARACTERISTICS ($V^+=12V^{*1}$, $T_a=25^\circ C$)

● ERROR AMPLIFIER

PARAMETER	SYMBOL	TEST CONDITION	MIN.	TYP.	MAX.	UNIT
Voltage Feedback input Threshold 1	V_{FB1}	$V^+=12V$	2.465	2.500	2.535	V
Voltage Feedback input Threshold 2	V_{FB2}	$V^+=28V$	2.440	2.500	2.540	V
Line Regulation	RegLine	$V^+=12\sim 28V$	—	1.0	10	mV
Input Bias Current	I_{IB}	$V_{FB}=0V$	—	-0.1	-0.5	μA
Transconductance	gm		80	100	130	μmho
Output Current (Source)	I_{OSO}	$V_{FB}=2.3V$	—	10	—	μA
Output Current (Sink)	I_{OSI}	$V_{FB}=2.7V$	—	10	—	μA
Output Voltage Swing 1	$V_{OH(OA)}$	$V_{FB}=2.3V$ (High State)	5.8	6.4	—	V
Output Voltage Swing 2	$V_{OL(OA)}$	$V_{FB}=2.7V$ (Low State)	—	1.7	2.4	V

● OVERVOLTAGE COMPARATOR

PARAMETER	SYMBOL	TEST CONDITION	MIN.	TYP.	MAX.	UNIT
Voltage Feedback Input Threshold	$V_{FB(OV)}$		1.065 $\times V_{FB}$	1.080 $\times V_{FB}$	1.095 $\times V_{FB}$	V

● MULTIPLIER

PARAMETER	SYMBOL	TEST CONDITION	MIN.	TYP.	MAX.	UNIT
Input Bias Current	I_{IB}	$V_{FB}=0V$ (FB Pin)	—	-0.1	-0.5	μA
Input Threshold	$V_{IH(M)}$	(FB Pin)	1.05 V_{OL} $\times (EA)$	1.20 V_{OL} $\times (EA)$	—	V
Dynamic Input Voltage Range	V_{PIN3}	Multiplier Input Pin	0~2.5	0~3.5	—	V
	V_{PIN2}	Compensation Pin	$V_{IH(M)}$ ~	$V_{IH(M)}$ ~	—	V
Multiplier Gain ^{**2}	K	$V_{mp}=0.5V$, $V_{comp}=V_{IH(M)}+1.0V$	0.43 +1.0V	0.65 +1.5V	0.87	μmho

● ZERO CURRENT DETECTOR

PARAMETER	SYMBOL	TEST CONDITION	MIN.	TYP.	MAX.	UNIT
Input Threshold Voltage	V_{IH}	V^+ Increasing	1.33	1.60	1.87	V
Hysteresis	V_H	V^+ Decreasing	100	200	300	mV
Input Clamp Voltage	V_{IH}	High State ($I_{DET}=+3.0mA$)	5.20	5.80	—	V
	V_{IL}	Low State ($I_{DET}=-3.0mA$)	0.30	0.70	1.00	V

6

■ ELECTRICAL CHARACTERISTICS ($V^+=12V^{**1}$, $T_a=25^\circ C$)

● CURRENT SENSING COMPARATOR

PARAMETER	SYMBOL	TEST CONDITION	MIN.	TYP.	MAX.	UNIT
Input Bias Current	I_{IB}	$I_{source}=0V$	—	-0.15	-1.0	μA
Input Offset Voltage	V_{IO}	$V_{source}=1.10V, V_M=0V$	—	9.0	25.0	mV
Maximum Current Sense Input Threshold ^{**3}	$V_{th(MAX)}$		1.30	1.50	1.80	V
Delay to Output	t_{PHL}		—	200	—	nS

● DRIVE OUTPUT

PARAMETER	SYMBOL	TEST CONDITION	MIN.	TYP.	MAX.	UNIT
Output Voltage	V_{OL1}	$I_{sink}=20mA$	—	0.3	0.8	V
Low State	V_{OL2}	$I_{sink}=200mA$	—	2.4	3.3	V
Output Voltage	V_{OH1}	$I_{source}=20mA$	9.8	10.3	—	V
High State	V_{OH2}	$I_{source}=200mA$	7.8	8.4	—	V
Output Voltage	$V_{C(MAX)}$	$I_{source}=20mA$	14	16	18	V
High State		$CL=15pF, V^+=30V$				
Output Voltage	t_r	$CL=1.0nF$	—	100	150	nS
Rise Time						
Output Voltage	t_f	$CL=1.0nF$	—	50	120	nS
Fall Time						
Output Voltage with UVLO Activated	$V_{C(UVLO)}$	$V^+=7V, I_{sink}=1.0mA$	—	0.1	0.5	V

● RESTART TIMER

PARAMETER	SYMBOL	TEST CONDITION	MIN.	TYP.	MAX.	UNIT
Restart Time Delay	t_{DLY}		200	620	—	μS

6

■ ELECTRICAL CHARACTERISTICS (V⁺=12V^{*1}, T_a=25°C)

● UNDERVOLTAGE LOCKOUT

PARAMETER	SYMBOL	TEST CONDITION	MIN.	TYP.	MAX.	UNIT
(NJM2375)						
Startup Threshold	V _{th(on)}	V ⁺ Increasing	11.5	13.0	14.5	V
Minimum Operating Voltage After Turn-On	V _{shutdown}	V ⁺ Decreasing	7.0	8.0	9.0	V
Hysteresis	V _H		3.8	5.0	6.2	V
(NJM2375A)						
Startup Threshold	V _{th(on)}	V ⁺ Increasing	9.4	10.4	11.4	V
Minimum Operating Voltage After Turn-On	V _{shutdown}	V ⁺ Decreasing	6.8	7.8	8.8	V
Hysteresis	V _H		1.4	2.6	3.8	V

● TOTAL DEVICE

PARAMETER	SYMBOL	TEST CONDITION	MIN.	TYP.	MAX.	UNIT
Power Supply Current						
Startup	I _{cc1}	V ⁺ =7.0V	—	0.25	0.4	mA
Operating	I _{cc2}		—	6.5	12	mA
Dynamic Operating	I _{cc3}	50kHz, CL=1.0nF	—	9.0	20	mA
Power Supply Zener Voltage ^{*4}	V _Z	I _{cc} =25mA	30	36	—	V

● NOTES

※1 : Adjust V⁺ above the startup threshold before setting to 12V.

$$\text{※2 : } K = \frac{V_{th(max)}}{V_M \times (V_{comp} - V_{th(M)})}$$

※3 : This parameter is measured with V_{FB}=0V, and V_M=3.0V.

※4 : Do not supply higher voltage above the zener voltage to 8pin, because the internal zener diode protects the IC from surge.

NJM2375/A

TYPICAL APPLICATIONS

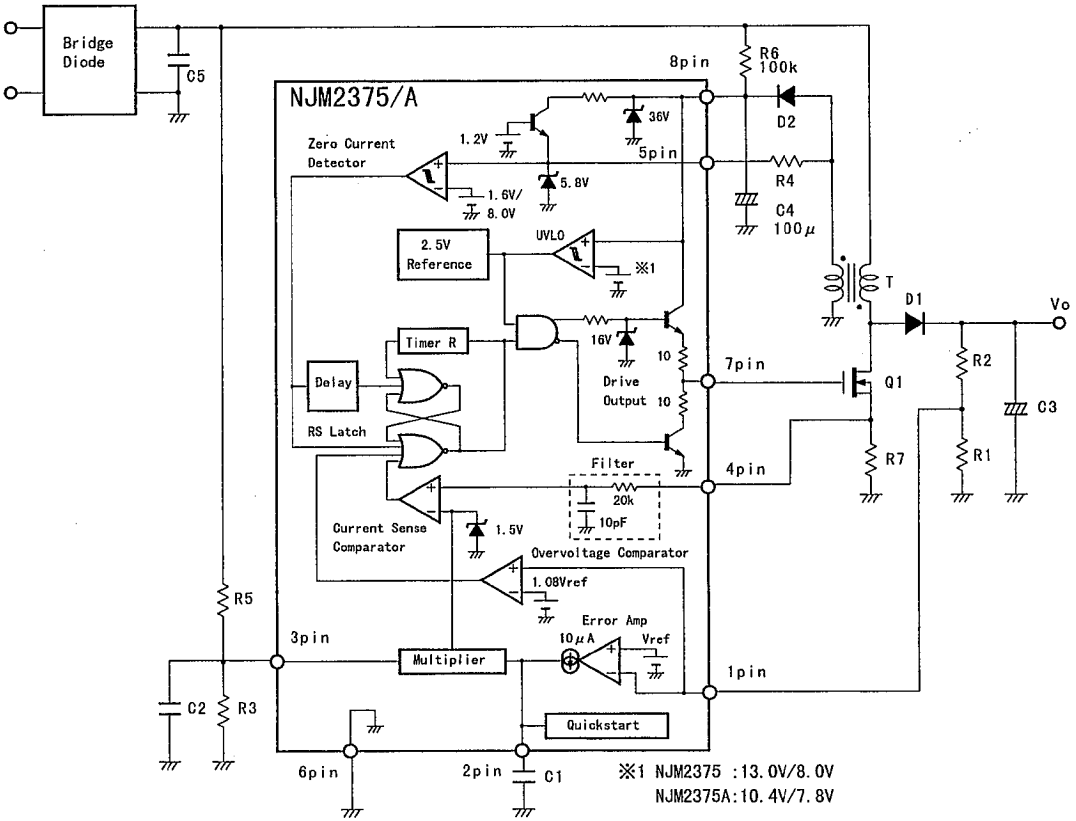

6

■ TYPICAL CHARACTERISTICS

Current Sense Input Threshold vs. Multiplier Input
($V^+=12V, T_a=25^\circ C$)

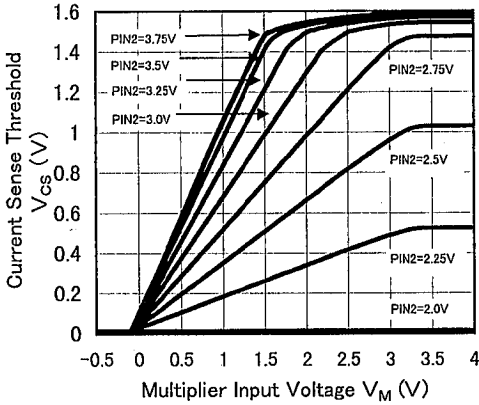

Current Sense Input Threshold vs. Multiplier Input (Expanded View)
($V^+=12V, T_a=25^\circ C$)

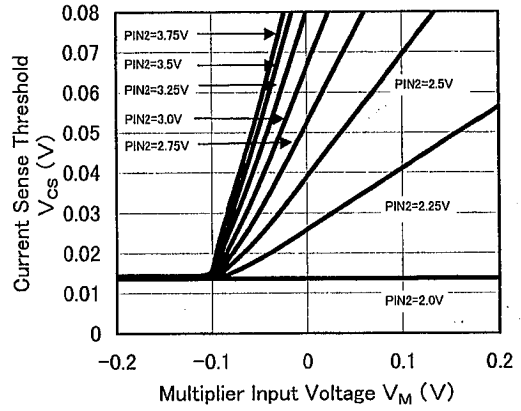

Supply Current vs. Supply Voltage (NJM2375)
($V_{FB}=0V, C_L=1nF, f=50kHz, T_a=25^\circ C$)

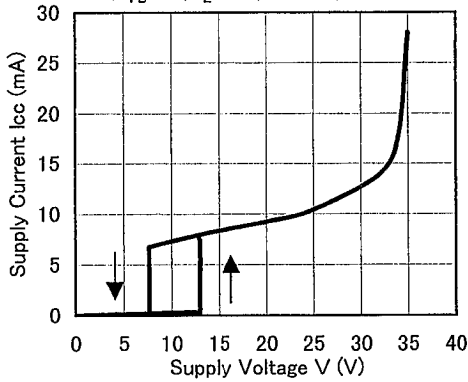

Supply Current vs. Supply Voltage (NJM2375A)
($V_{FB}=0V, C_L=1nF, f=50kHz, T_a=25^\circ C$)

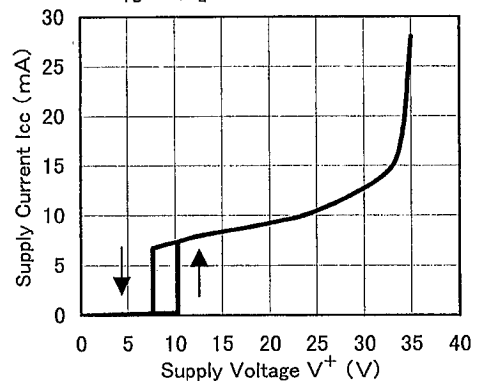

Drive Output Voltage vs. Output Current
($V^+=12V, T_a=25^\circ C$)

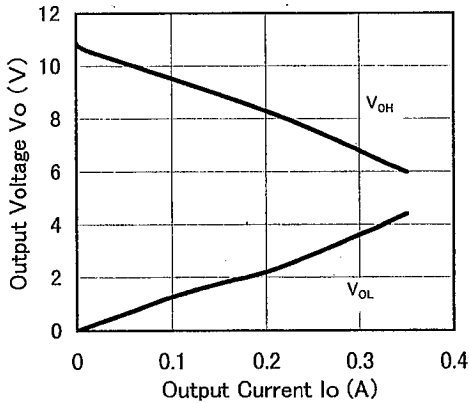

Drive Output Waveform
($V^+=12V, C_L=1nF, f=150kHz, T_a=25^\circ C$)

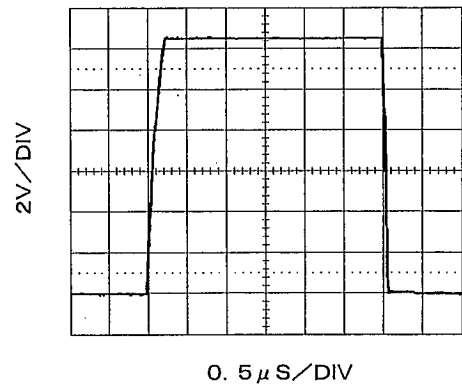

TYPICAL CHARACTERISTICS

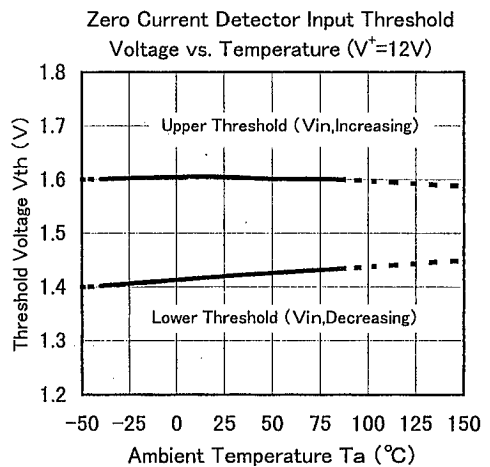
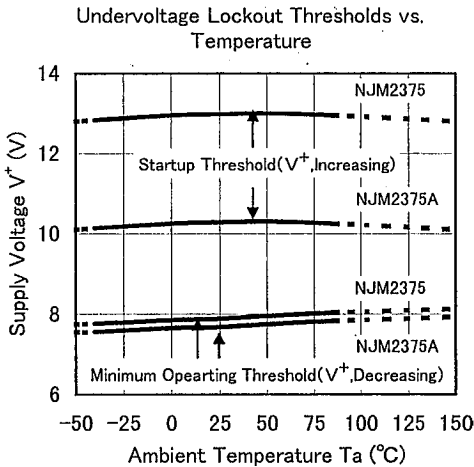
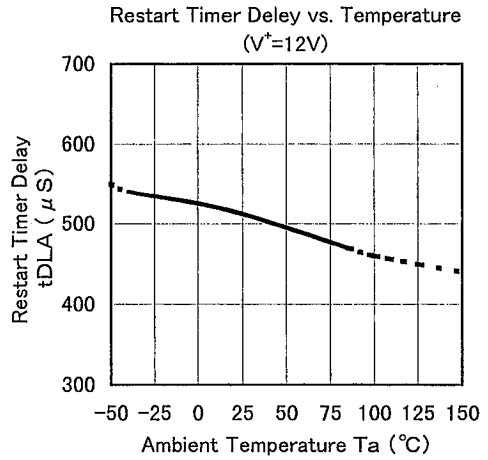
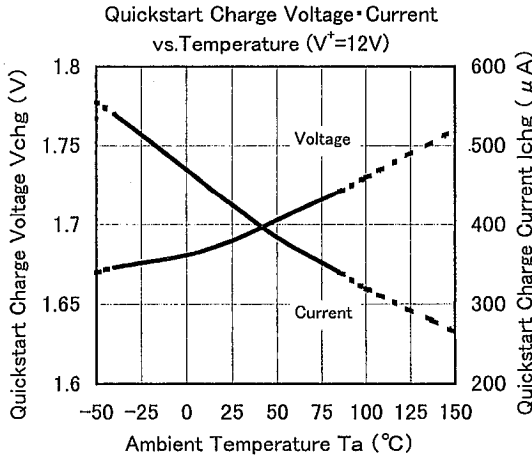
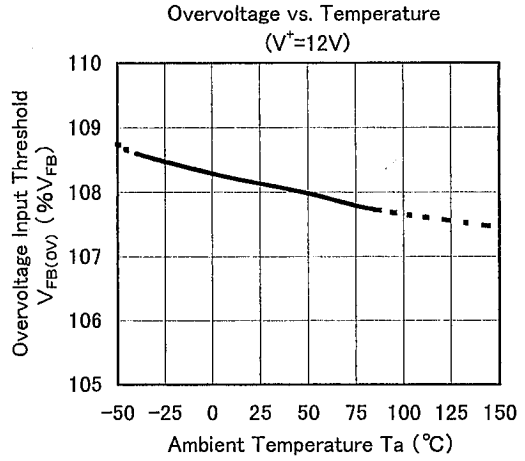
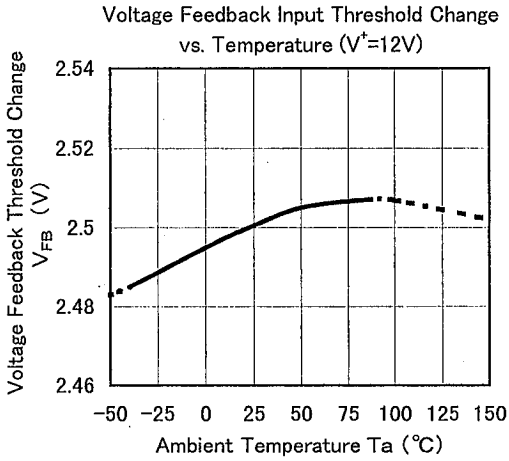

6

MEMO

[CAUTION]

The specifications on this databook are only given for information, without any guarantee as regards either mistakes or omissions. The application circuits in this databook are described only to show representative usages of the product and not intended for the guarantee or permission of any right including the industrial rights.