

FEATURES

- **WIDE FREQUENCY RESPONSE:** 2.7 GHz
- **LOW VOLTAGE OPERATION:** 3 V NOMINAL (1.8 MIN)
- **LOW POWER CONSUMPTION:** 22.5 mW TYP
- **SUPER SMALL PACKAGE**
- **TAPE AND REEL PACKAGING OPTION AVAILABLE**

DESCRIPTION

The UPC2745T is a Silicon Monolithic integrated circuit which is manufactured using the NESAT III process. The NESAT III process produces transistors with f_t approaching 20 GHz. This device is suitable as a buffer amplifier for cellular and cordless telephone applications. Operating on a 3 volt supply (1.8 volt minimum) this IC is ideally suited for hand-held, portable designs.

NEC's stringent quality assurance and test procedures ensure the highest reliability and performance.

ELECTRICAL CHARACTERISTICS (T_A = 25°C, Z_L = Z_S = 50 Ω)

NOISE FIGURE AND GAIN vs. FREQUENCY
V_{CC} = 3.0 V, I_{CC} = 7.5 mA

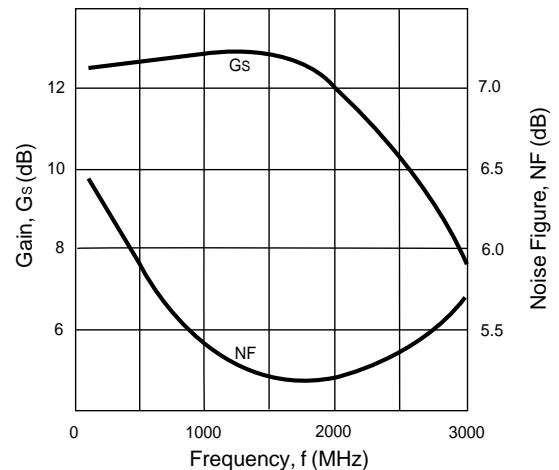

PART NUMBER PACKAGE OUTLINE			UPC2745T TO6		
SYMBOLS	PARAMETERS AND CONDITIONS	UNITS	MIN	TYP	MAX
I _{CC}	Circuit Current (no signal) V _{CC} = 3.0 V V _{CC} = 1.8 V	mA mA	5.0	7.5 4.5	10.0
G _s	Small Signal Gain, f = 500 MHz, V _{CC} = 3.0 V f = 1000 MHz, V _{CC} = 3.0 V f = 2000 MHz, V _{CC} = 3.0 V f = 500 MHz, V _{CC} = 1.8 V	dB dB dB dB	9	12 12 11 7	14
f _u ¹	Upper Limit Operating Frequency, V _{CC} = 3.0 V V _{CC} = 1.8 V	GHz GHz	2.3	2.7 1.8	
P _{SAT}	Saturated Output Power, f = 500 MHz, V _{CC} = 3.0 V f = 1000 MHz, V _{CC} = 3.0 V f = 2000 MHz, V _{CC} = 3.0 V f = 500 MHz, V _{CC} = 1.8 V	dBm dBm dBm dBm	-4	-1 -2.5 -3.5 -11	
NF	Noise Figure, f = 500 MHz, V _{CC} = 3.0 V f = 1000 MHz, V _{CC} = 3.0 V f = 2000 MHz, V _{CC} = 3.0 V f = 500 MHz, V _{CC} = 1.8 V	dB dB dB dB		6 5.5 5.7 8	7.5
RL _{IN}	Input Return Loss, f = 500 MHz, V _{CC} = 3.0 V f = 1000 MHz, V _{CC} = 3.0 V f = 2000 MHz, V _{CC} = 3.0 V f = 500 MHz, V _{CC} = 1.8 V	dB dB dB dB	8	11 13 14 6.5	
RL _{OUT}	Output Return Loss, f = 500 MHz, V _{CC} = 3.0 V f = 1000 MHz, V _{CC} = 3.0 V f = 2000 MHz, V _{CC} = 3.0 V f = 500 MHz, V _{CC} = 1.8 V	dB dB dB dB	2.5	5.5 6.5 8.5 6	
ISOL	Isolation, f = 500 MHz, V _{CC} = 3.0 V f = 1000 MHz, V _{CC} = 3.0 V f = 2000 MHz, V _{CC} = 3.0 V f = 500 MHz, V _{CC} = 1.8 V	dB dB dB dB	33	38 33 30 35	
OIP ₃	SSB Output Third Order Intercept, f ₁ = 500 MHz, f ₂ = 510 MHz, V _{CC} = 3.0 V f ₁ = 1000 MHz, f ₂ = 1010 MHz, V _{CC} = 3.0 V f ₁ = 500 MHz, f ₂ = 502 MHz, V _{CC} = 1.8 V	dBm dBm dBm		7 5 -5	
R _{TH} (J-A)	Thermal Resistance (Junction to Ambient) Free Air Mounted on a 50 x 50 x 1.6 mm epoxy glass PWB	°C/W °C/W			620 630

Note: 1. The gain at f_u is 3 dB down from the gain at 100 MHz.

ABSOLUTE MAXIMUM RATINGS¹ (T_A = 25°C)

SYMBOLS	PARAMETERS	UNITS	RATINGS
V _{CC}	Supply Voltage	V	4.0
I _{CC}	Total Supply Current	mA	16
P _{IN}	Input Power	dBm	0
P _T	Total Power Dissipation ²	mW	280
T _{OP}	Operating Temperature	°C	-40 to +85
T _{STG}	Storage Temperature	°C	-55 to +150

Notes:

1. Operation in excess of any one of these parameters may result in permanent damage.
2. Mounted on a 50 x 50 x 1.6 mm epoxy glass PWB (T_A = 85°C).

RECOMMENDED OPERATING CONDITIONS

SYMBOLS	PARAMETERS	UNITS	MIN	TYP	MAX
V _{CC}	Supply Voltage	V	1.8	3	3.3
T _{OP}	Operating Temperature	°C	-40	25	85

TEST CIRCUIT

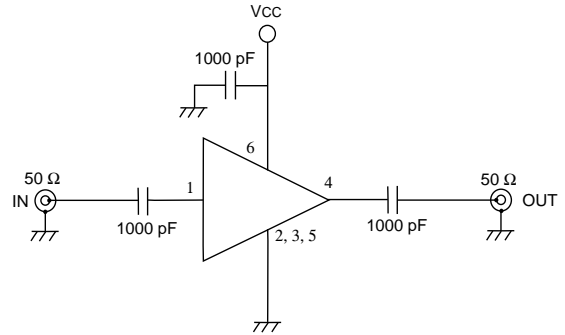

TYPICAL PERFORMANCE CURVES (T_A = 25°C)

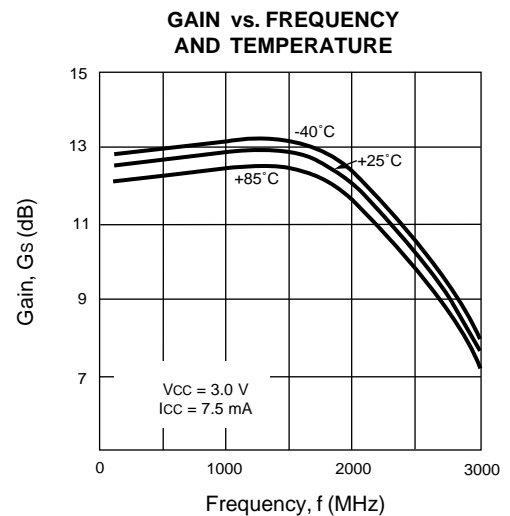
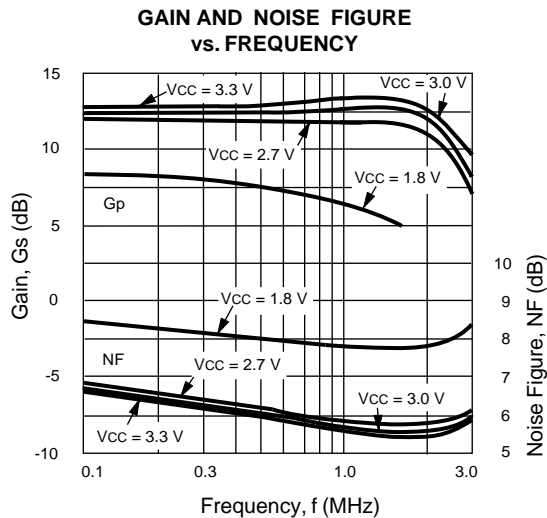
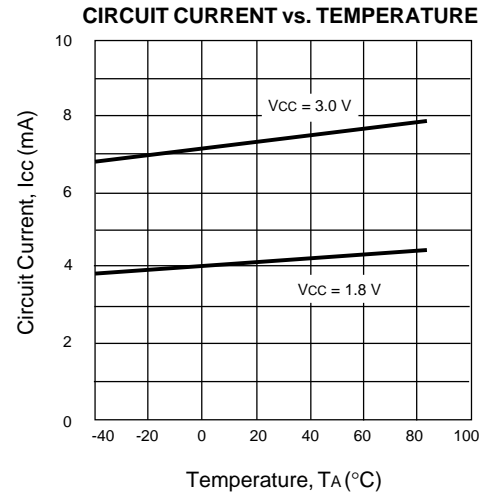
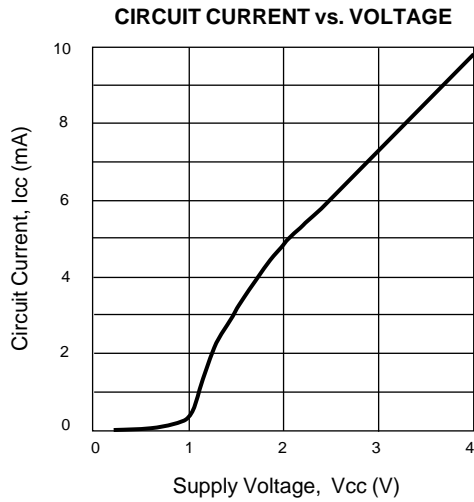

TYPICAL PERFORMANCE CURVES (TA = 25°C)

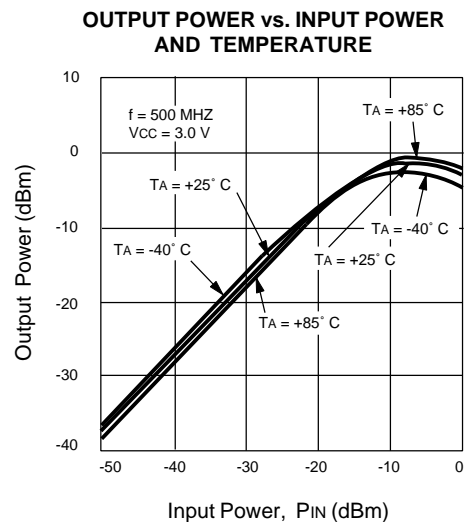
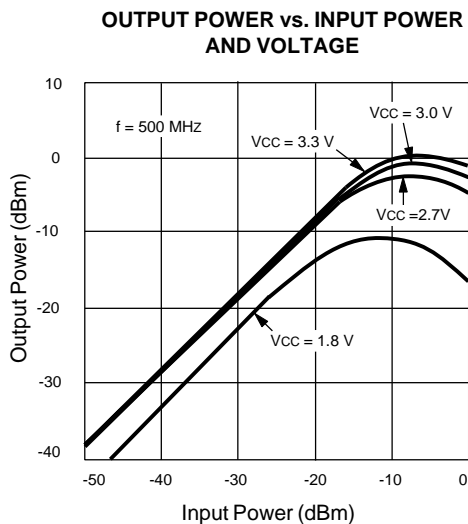
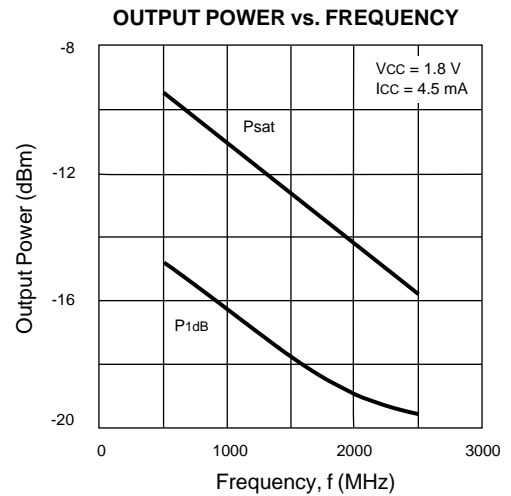
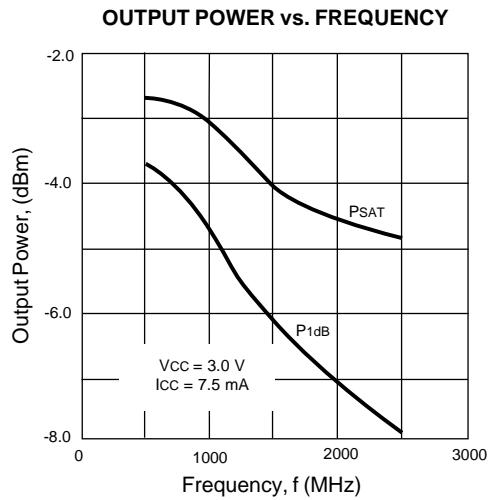
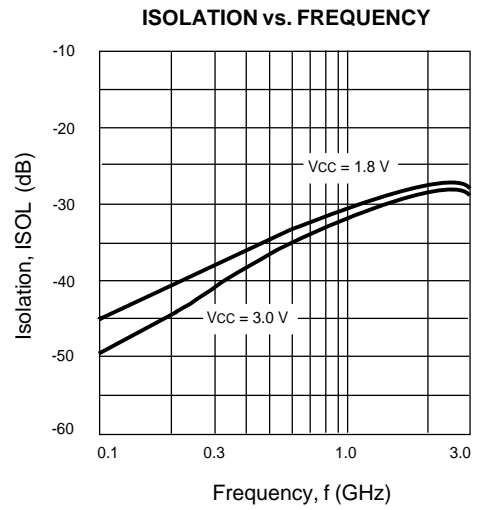
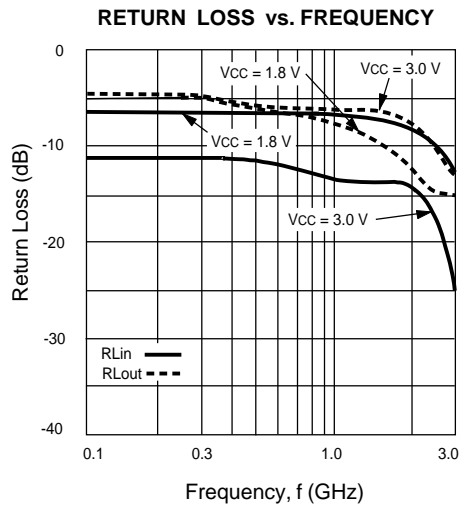

TYPICAL SCATTERING PARAMETERS (T_A = 25°C)

V_{CC} = 3.0 V, I_{CC} = 7.5 mA

FREQUENCY (GHz)	S ₁₁		S ₂₁		S ₁₂		S ₂₂		K ¹	S ₂₁ (dB)
	MAG	ANG	MAG	ANG	MAG	ANG	MAG	ANG		
0.1	0.267	-2.0	4.22	-5.2	0.003	92.2	0.611	-4.1	23.00	12.5
0.2	0.277	-5.5	4.23	-11.9	0.006	82.3	0.597	-9.2	11.71	12.5
0.3	0.278	-9.3	4.23	-18.7	0.009	74.0	0.584	-13.5	7.97	12.5
0.4	0.276	-13.8	4.24	-25.6	0.012	66.5	0.569	-17.1	6.12	12.5
0.5	0.276	-17.5	4.24	-32.0	0.014	60.1	0.557	-20.4	5.33	12.5
0.6	0.275	-20.8	4.26	-38.8	0.016	56.2	0.542	-23.4	4.75	12.6
0.7	0.274	-24.4	4.30	-45.8	0.017	54.6	0.530	-26.1	4.51	12.7
0.8	0.273	-26.9	4.31	-52.9	0.018	53.5	0.520	-29.1	4.31	12.7
0.9	0.272	-29.9	4.32	-60.1	0.020	51.0	0.511	-31.8	3.92	12.7
1.0	0.272	-31.4	4.34	-67.5	0.021	49.8	0.504	-34.3	3.74	12.8
1.2	0.270	-34.3	4.38	-82.0	0.023	46.4	0.493	-40.3	3.43	12.8
1.4	0.266	-37.3	4.37	-97.6	0.024	42.6	0.481	-46.5	3.35	12.8
1.6	0.258	-40.2	4.25	-113.8	0.024	42.0	0.465	-53.1	3.53	12.6
1.8	0.250	-43.1	4.08	-129.6	0.025	41.4	0.438	-58.6	3.66	12.2
2.0	0.242	-46.0	3.82	-145.2	0.026	40.9	0.401	-63.6	3.93	11.6
2.2	0.231	-48.7	3.50	-161.3	0.027	40.3	0.352	-68.6	4.35	10.9
2.4	0.215	-50.4	3.24	-174.5	0.027	39.8	0.309	-71.9	4.91	10.2
2.6	0.195	-51.4	2.97	172.6	0.027	39.2	0.259	-74.4	5.59	9.5
2.8	0.175	-52.3	2.69	160.3	0.026	38.7	0.215	-74.1	6.61	8.6
3.0	0.153	-51.3	2.41	150.5	0.026	38.2	0.165	-70.8	7.60	7.6

V_{CC} = 1.8 V, I_{CC} = 4.5 mA

FREQUENCY (GHz)	S ₁₁		S ₂₁		S ₁₂		S ₂₂		K ¹	S ₂₁ (dB)
	MAG	ANG	MAG	ANG	MAG	ANG	MAG	ANG		
0.1	0.467	-1.4	2.47	-8.7	0.003	63.6	0.608	-5.5	33.13	7.9
0.2	0.483	-3.9	2.40	-19.2	0.007	62.0	0.596	-11.7	14.57	7.6
0.3	0.494	-7.6	2.34	-29.6	0.011	60.3	0.580	-17.2	9.60	7.4
0.4	0.498	-10.7	2.29	-39.0	0.015	58.7	0.557	-21.3	7.40	7.2
0.5	0.500	-14.9	2.22	-48.1	0.018	57.0	0.538	-25.9	6.51	6.9
0.6	0.503	-18.6	2.14	-56.9	0.021	55.4	0.511	-29.4	5.99	6.6
0.7	0.505	-22.5	2.08	-64.9	0.024	53.8	0.501	-33.8	5.44	6.4
0.8	0.507	-26.1	2.01	-73.5	0.026	52.1	0.480	-36.1	5.31	6.1
0.9	0.510	-30.2	1.94	-81.8	0.027	50.5	0.470	-40.4	5.34	5.8
1.0	0.512	-34.2	1.88	-88.2	0.028	48.8	0.446	-43.8	5.46	5.5
1.2	0.508	-41.3	1.79	-104.2	0.030	45.6	0.415	-49.3	5.57	5.1
1.4	0.498	-48.6	1.70	-120.4	0.031	42.3	0.390	-54.6	5.90	4.6
1.6	0.480	-55.4	1.61	-134.5	0.032	39.0	0.360	-58.7	6.36	4.1
1.8	0.463	-62.1	1.51	-147.3	0.032	35.7	0.326	-61.7	7.14	3.6
2.0	0.438	-69.0	1.43	-160.8	0.032	32.5	0.291	-63.3	7.98	3.1
2.2	0.396	-76.2	1.35	-177.2	0.032	29.2	0.260	-64.1	9.02	2.6
2.4	0.349	-81.5	1.27	174.1	0.033	25.9	0.234	-64.2	9.85	2.1
2.6	0.304	-87.7	1.21	162.9	0.032	22.6	0.205	-62.7	11.19	1.7
2.8	0.273	-93.6	1.15	152.5	0.030	19.3	0.179	-59.6	12.96	1.2
3.0	0.230	-96.7	1.09	144.7	0.029	16.1	0.160	-54.6	14.59	0.7

Note:

1. K factor Calculation:

$$K = \frac{1 + |\Delta|^2 - |S_{11}|^2 - |S_{22}|^2}{2 |S_{12} S_{21}|}, \Delta = S_{11} S_{22} - S_{21} S_{12}$$

OUTLINE DIMENSIONS (Units in mm)

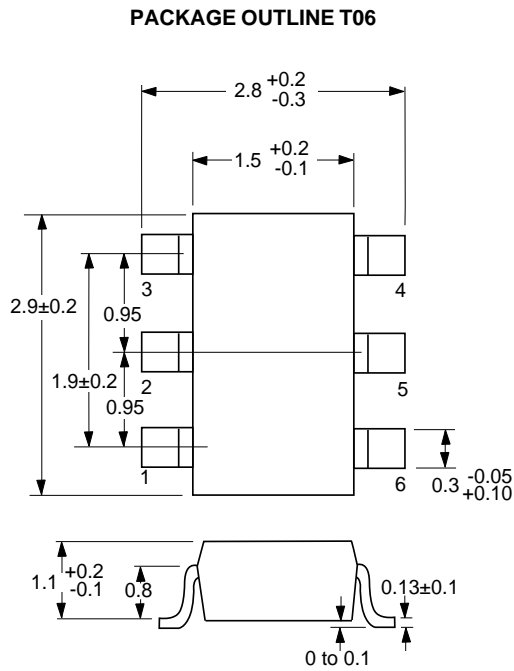

Note:
All dimensions are typical unless otherwise specified.

LEAD CONNECTIONS

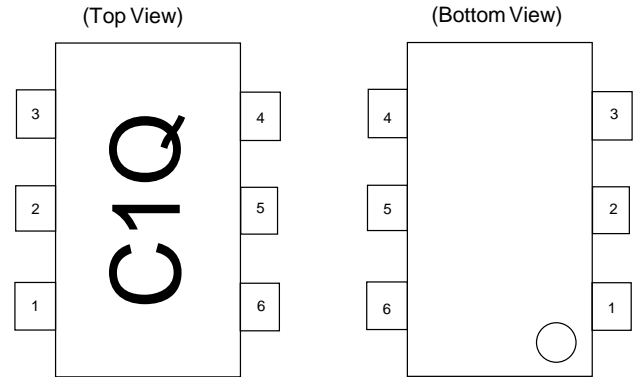

1. INPUT
2. GND
3. GND
4. OUTPUT
5. GND
6. Vcc

EQUIVALENT CIRCUIT

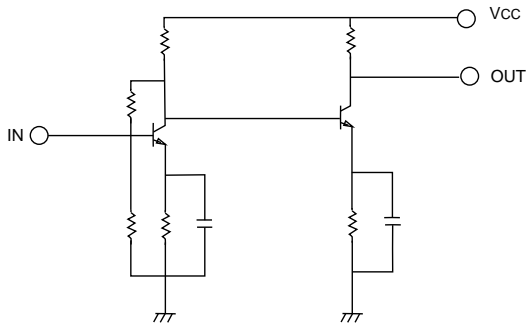

RECOMMENDED P.C.B. LAYOUT (Units in mm)

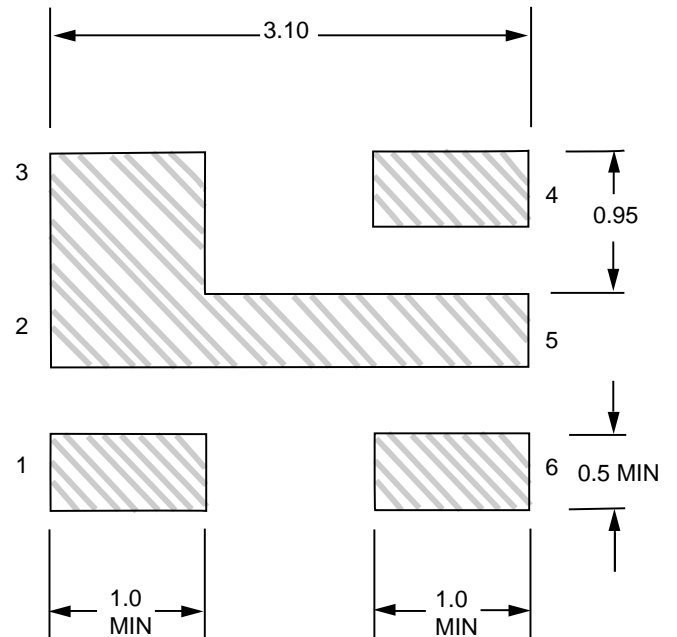

ORDERING INFORMATION

PART NUMBER	QTY
UPC2745T-E3	3K/Reel

Note:
Embossed Tape, 8 mm wide.

EXCLUSIVE AGENT FOR **NEC Corporation** RF & MICROWAVE SEMICONDUCTOR PRODUCTS - U.S. & CANADA