

BIPOLAR ANALOG INTEGRATED CIRCUIT

μ PC8110GR

1 GHz DIRECT QUADRATURE MODULATOR FOR DIGITAL MOBILE COMMUNICATION

DESCRIPTION

The μ PC8110GR is a silicon monolithic integrated circuit designed as 1 GHz direct quadrature modulator for digital mobile communication systems. This modulator housed in a 20 pin plastic SSOP that easy to install and contributes to miniaturizing the system.

The device has power save function and can operates 2.7 to 3.6 V supply voltage to realize low power consumption.

FEATURES

- Direct modulation range : 800 MHz to 1 GHz
- Supply voltage range : $V_{cc} = 2.7$ to 3.6 V
- Low operation current : $I_{cc} = 24$ mA typical @ $V_{cc} = 3$ V
- Low phase difference due to digital phase shifter is adopted.
- 20 pin SSOP suitable for high density surface mounting.
- Low current sleep mode

APPLICATION

- Digital cellular phone (PDC, IS-54/IS-136, GSM etc..)

ORDERING INFORMATION

PART NUMBER	PACKAGE	PACKING FORM
μ PC8110GR-E1	20 pin plastic SSOP	Carrier tape width 12 mm. Q'ty 2.5 kp/Reel Pin 1 indicated pull-out direction of tape.

Remark For evaluation sample order, please contact your local NEC sales office. (Order number: μ PC8110GR)

Caution electro-static sensitive device

The information in this document is subject to change without notice. Before using this document, please confirm that this is the latest version.
Not all devices/types available in every country. Please check with local NEC representative for availability and additional information.

INTERNAL BLOCK DIAGRAM AND PIN CONNECTIONS

(Top View)

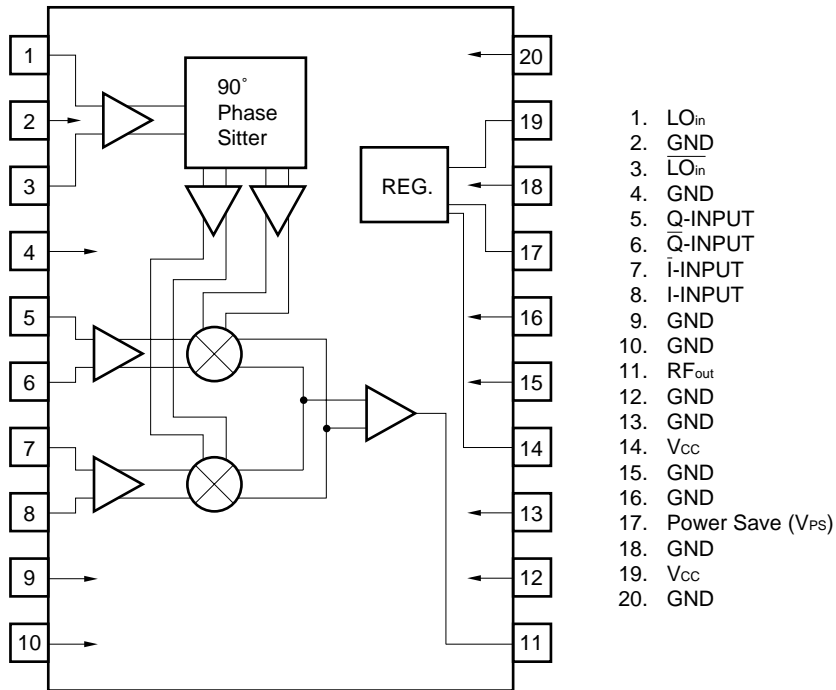

SERIES PRODUCTS

SERIES TYPE	PART NUMBER	f LO _{1in} (MHz)	f MOD _{out} (MHz)	f I/Q (MHz)	Up-Converter f RF _{out} (MHz)	APPLICATION
150 MHz Quadrature MOD	μPC8101GR	100 to 300	50 to 150	DC to 0.5	External	CT2, Digital Comm.
Up-Con+Quadrature MOD	μPC8104GR	100 to 400		DC to 10	900 to 1900	PHS, PDC etc..
400 MHz Quadrature MOD	μPC8105GR	100 to 400		DC to 10	External	PDC, IS-136, GSM, PHS
1 GHz direct Quad MOD	μPC8110GR	800 to 1000		DC to 10	Direct	PDC, IS-136, GSM etc.

Remark As for detail information of series products, please refer to each data sheet.

APPLICATION EXAMPLE

PDC 900 MHz (Direct Modulation Type)

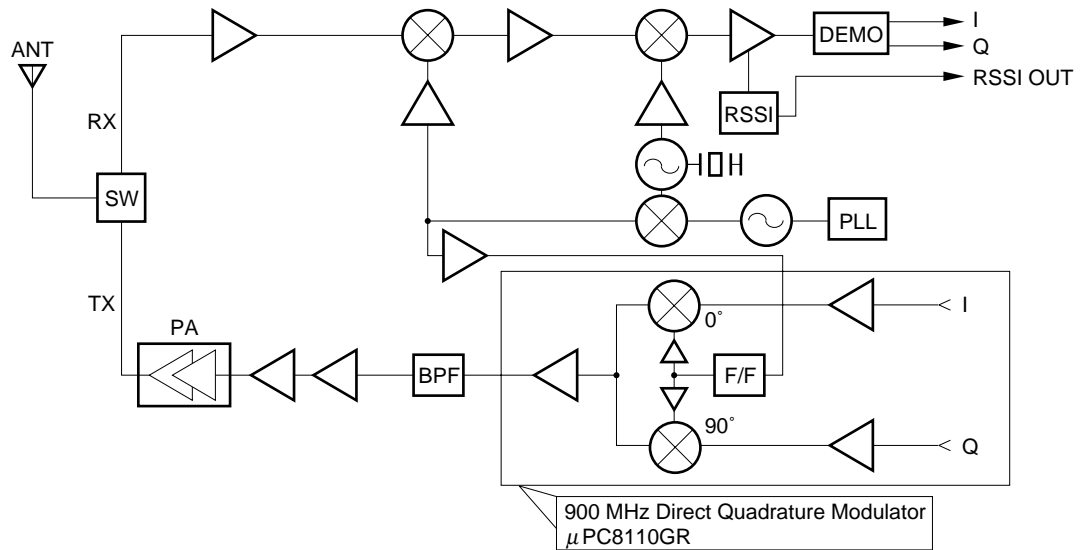

ABSOLUTE MAXIMUM RATINGS

PARAMETER	SYMBOL	RATING	UNIT	TEST CONDITIONS
Supply Voltage	V _{CC}	4.0	V	T _A = +25 °C
Power Save Voltage	V _{PS}	4.0	V	T _A = +25 °C
Power Dissipation	P _D	430	mW	T _A = +85 °C ^{Note 1}
Operating Temperature	T _{opt}	-40 to +85	°C	
Storage Temperature	T _{stg}	-55 to +150	°C	

Note 1. Mounted on 50 × 50 × 1.6 mm double copper clad epoxy glass board

RECOMMENDED OPERATING CONDITIONS

PARAMETER	SYMBOL	MIN.	TYP.	MAX.	UNIT	TEST CONDITIONS
Supply Voltage	V _{CC}	2.7	3.0	3.6	V	
Operating Temperature	T _{opt}	-40	+25	+85	°C	
Lo Input Frequency	f _{LoIn}	800	900	1000	MHz	
Lo Input Power Level	PL _{OIn}	-15	-10	-7	dBm	
I/Q Input Frequency	f _{I/Qin}	DC		10	MHz	
I/Q Input Voltage	V _{I/Qin}			500	mV _{p-p}	Single ended input
				250		Differential input

ELECTRICAL CHARACTERISTICS (TA = 25 °C, Vcc = 3.0 V, Unless Otherwise Specified Vps ≥ 2.2 V (High))

PARAMETER	SYMBOL	MIN.	TYP.	MAX.	UNIT	TEST CONDITIONS
Circuit Current	I _{cc}	20	24	33	mA	No input signal
Circuit Current at Power Save Mode	I _{cc(PS)}			10	μA	V _{PS} ≤ 0.5 V (Low)
Maximum Output Power	P _{o(sat)}	-13	-10		dBm	f _{LOin} = 948 MHz
Lo Carrier Leak	LoL		-35	-30	dBc	P _{LOin} = -10 dBm f _{I/Q} = 2.625 kHz
Image Rejection (Side Band Leak)	ImR		-40	-30	dBc	I/Q (DC) = V _{CC} /2
I/Q 3rd Order Intermodulation Distortion	IM _{3/IQ}		-45	-30	dBc	V _{I/Qin} = 500 mV _{p-p} (Single ended)
Power Save Rise Time	T _{PS(RISE)}		3	5	μs	V _{PS} : Low → High
Power Save Fall Time	T _{PS(FALL)}		2	5	μs	V _{PS} : High → Low

STANDARD CHARACTERISTICS FOR REFERENCE

(TA = +25 °C, Vcc = 3.0 V, Unless Otherwise Specified Vps ≥ 2.2 V (High))

PARAMETER	SYMBOL	MIN.	TYP.	MAX.	UNIT	TEST CONDITIONS
I/Q Input Impedance	Z _{I/Qin}		150		kΩ	f _{I/Q} = DC to 10 MHz
Lo Input VSWR	VSWR (Lo)		1.5 : 1		-	f _{LO} = 948 MHz
RF Output VSWR	VSWR (RF)		1.5 : 1		-	f _{LO} = 948 MHz

PIN EXPLANATION

Pin No.	ASSIGNMENT	SUPPLY VOL. (V)	PIN VOL. (V)	FUNCTION AND APPLICATION	EQUIVALENT CIRCUIT
1	L_{oin}	—	2.6	L_o input for phase shifter. Connect around 50 Ω between 1 and 3 pin to match to 50 Ω.	
2 18	GND (for Local Amp. Block)	0	—	Connect to the ground with minimum inductance. Track length should be kept as short as possible.	
3	$\overline{L_{oin}}$	—	2.6	Bypass of L_o input. This pin is grounded through around 33 pF capacitor.	
5	Q	$V_{cc}/2$	—	Input for Q signal. This input impedance is 150 kΩ. In case of that I/Q input signals are single ended, amplitude of the signal is 500 mVp-p max. Note 2	
6	\overline{Q}	$V_{cc}/2$	—	Input for Q signal. This input impedance is 150 kΩ. In case of that I/Q input signals are single ended, $V_{cc}/2$ biased DC signal should be input. In case of that I/Q input signals are differential, amplitude of the signal is 250 mVp-p max. Note 2	
7	\overline{I}	$V_{cc}/2$	—	Input for I signal. This input impedance is 150 kΩ. In case of that I/Q input signals are single ended, $V_{cc}/2$ biased DC signal should be input. In case of that I/Q input signals are differential, amplitude of the signal is 250 mVp-p max. Note 2	
8	I	$V_{cc}/2$	—	Input for I signal. This input impedance is 150 kΩ. In case of that I/Q input signals are single ended, amplitude of the signal is 500 mVp-p max. Note 2	
9 13 16	GND (for Quadrature Modulator Block)	0	—	Connect to the ground with minimum inductance. Track length should be kept as short as possible.	—

Pin No.	ASSIGNMENT	SUPPLY VOL. (V)	PIN VOL. (V)	FUNCTION AND APPLICATION	EQUIVALENT CIRCUIT						
11	RF _{out}	—	1.6	Output from modulator. This is single-end push-pull amplifier. So this output impedance is Low.							
12	GND (for Output Push-pull Amplifier)	0	—	Connect to the ground with minimum inductance. Track length should be kept as short as possible.							
14	V _{cc} (for Output Amplifier of Modulator)	2.7 to 3.6	—	Supply voltage pin for Output Amplifier of modulator. Internal regulator can be kept stable condition of supply bias against the variable temperature or V _{cc} .							
17	Power Save	V _{P/S}	—	Power save control pin can be controlled ON/SLEEP state with bias as follows; <table border="1" style="margin: 10px auto;"> <thead> <tr> <th>V_{P/S}</th> <th>STATE</th> </tr> </thead> <tbody> <tr> <td>2.2 to 3.6</td> <td>ON</td> </tr> <tr> <td>0 to 0.5</td> <td>SLEEP</td> </tr> </tbody> </table>	V _{P/S}	STATE	2.2 to 3.6	ON	0 to 0.5	SLEEP	
V _{P/S}	STATE										
2.2 to 3.6	ON										
0 to 0.5	SLEEP										
19	V _{cc}	2.7 to 3.6	—	Supply voltage pin for modulator except output Amplifier. Internal regulator can be kept stable condition of supply bias against the variable temperature or V _{cc} .	—						
4 10 15 20	GND	0	—	Connect to the ground with minimum inductance. Track length should be kept as short as possible.	—						

Note 2. Relations between amplitude and V_{cc}/2 bias of input signal are following.

Supply Voltage V _{cc} (V)	I/Q DC Voltage (V) V _{cc} /2 = I = Ī = Q = Q̄	P/I/Qin - I/Q Input Signal - mVp-p	
		Single ended input I = Q	Differential input I = Ī = Q = Q̄
2.7 to 3.6	1.35 to 1.8	≤ 500	≤ 250

EXPLANATION OF INTERNAL FUNCTION

BLOCK	FUNCTION/OPERATION	BLOCK DIAGRAM
90 ° PHASE SHIFTER	Input signal from L_o is send to digital circuit of T-type flip-flop through frequency doubler. Output signal from T-type F/F is changed to same frequency as L_o input and that have quadrature phase shift, 0 °, 90 °, 180 °, 270 °. These circuits have function of self phase correction to make correctly quadrature signals.	<p>The block diagram illustrates the internal signal processing flow. It starts with an input signal 'from L_{Oin}' which passes through a frequency doubler block labeled '× 2'. The output then goes to a T-type flip-flop block labeled '÷ 2 F/F'. The signals from the flip-flop are then passed through two buffer amplifiers, represented by downward-pointing triangles. These amplified signals are fed into two double-balanced mixers, shown as circles with an 'X' inside. The first mixer has inputs labeled 'I' and 'I-bar', and the second has inputs labeled 'Q' and 'Q-bar'. The outputs of the mixers are combined in an adder block, and the final result is sent to a final amplifier (downward-pointing triangle) labeled 'to MOD_{out}'.</p>
BUFFER AMP.	Buffer amplifiers for each phase signals to send to each mixers.	
MIXER	Each signals from buffer amp. are quadrature modulated with two double-balanced mixers. High accurate phase and amplitude inputs are realized to good performance for image rejection.	
ADDER	Output signals from each mixers are added with adder and send to final amplifier.	

TYPICAL CHARACTERISTICS

Unless otherwise specified $T_A = +25\text{ }^\circ\text{C}$, $V_{CC} = V_{PS} = 3\text{ V}$, $I/Q\text{ DC}/\text{offset} = \overline{I/Q}\text{ DC offset} = 1.5\text{ V}$, $I/Q\text{ Input signal} = 500\text{ mV}_{p-p}$ (Single ended), $f_{I/Q} = 2.625\text{ kHz}$, $f_{LOin} = 948\text{ MHz}$, $P_{LOin} = -10\text{ dBm}$, $\langle PDC \rangle$ Transmission speed: 42 kbps, RNYQ: $a = 0.5$.

CIRCUIT CURRENT vs SUPPLY VOLTAGE

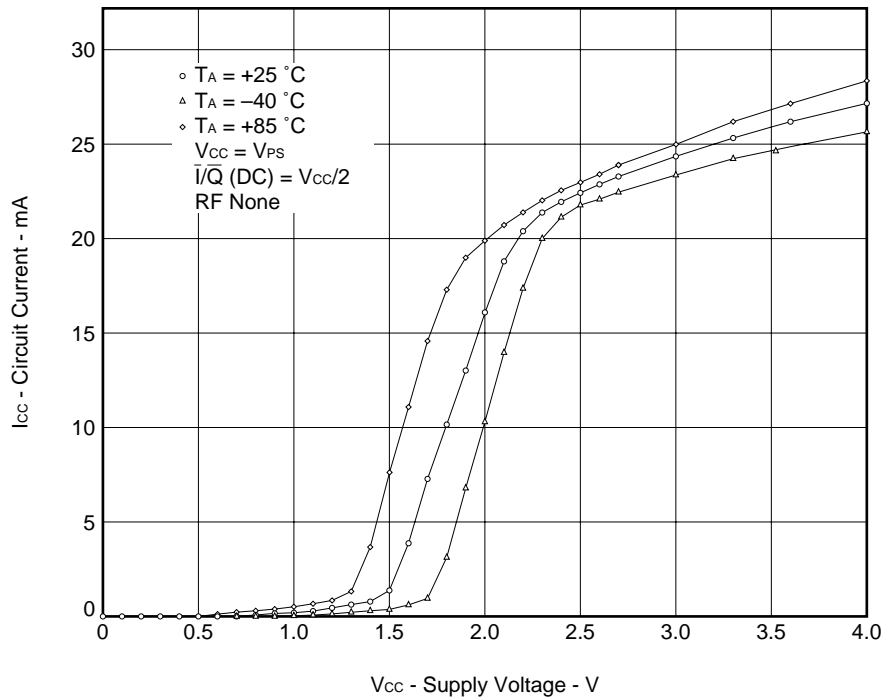

CIRCUIT CURRENT vs POWER SAVE VOLTAGE

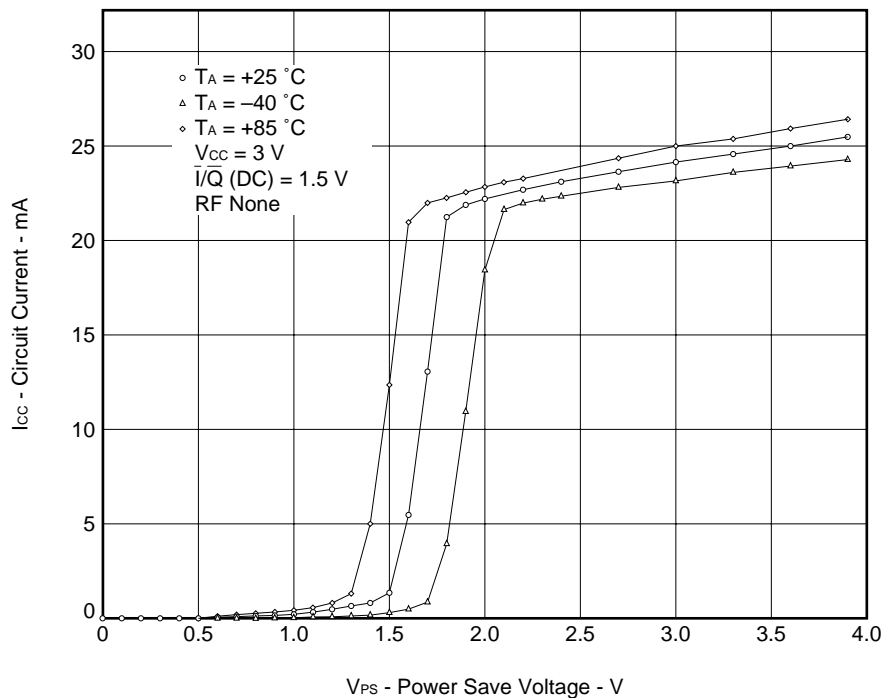

RF OUTPUT POWER vs I/Q INPUT SIGNAL
(at T_A = -40 °C)

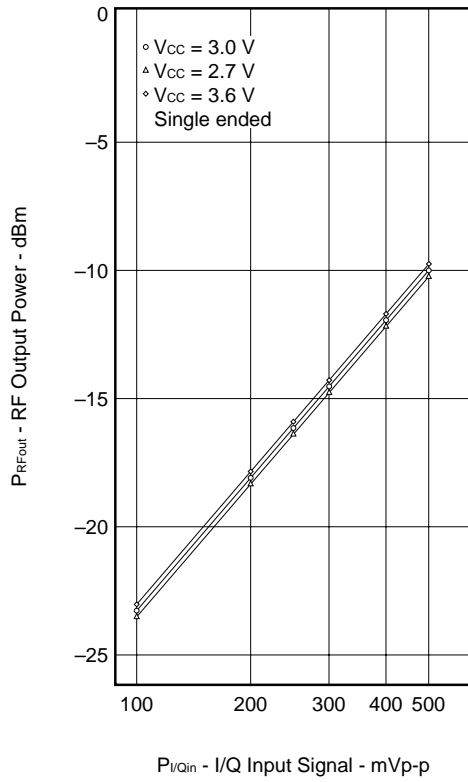

RF OUTPUT POWER vs I/Q INPUT SIGNAL
(at T_A = +25 °C)

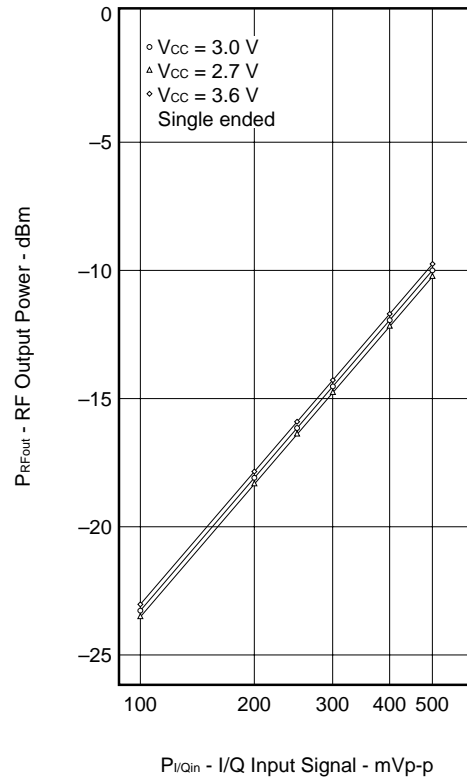

RF OUTPUT POWER vs I/Q INPUT SIGNAL
(at T_A = +85 °C)

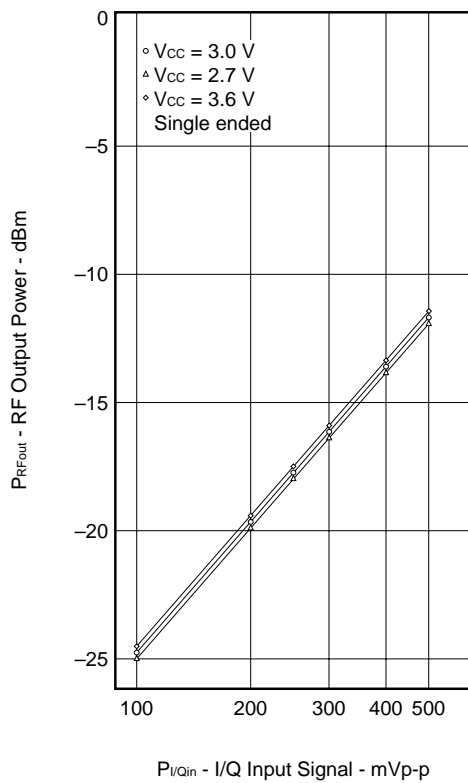

Lo INPUT FREQUENCY vs
 P_{RFout} , LoL, ImR, $IM_{3/1Q}$
 (at $V_{CC} = 2.7\text{ V}$, $T_A = -40\text{ }^\circ\text{C}$)

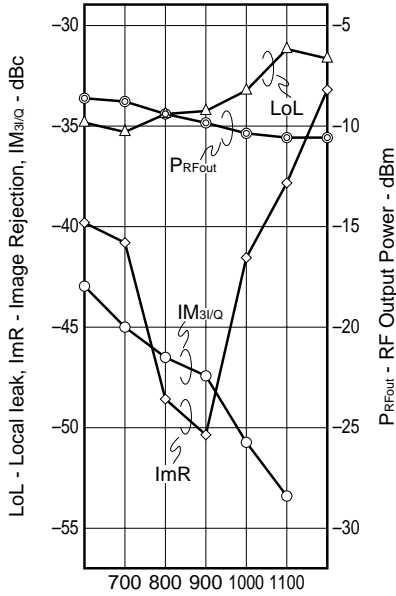

f_{lo} - Local Input Frequency - MHz

Lo INPUT FREQUENCY vs
 P_{RFout} , LoL, ImR, $IM_{3/1Q}$
 (at $V_{CC} = 3.0\text{ V}$, $T_A = -40\text{ }^\circ\text{C}$)

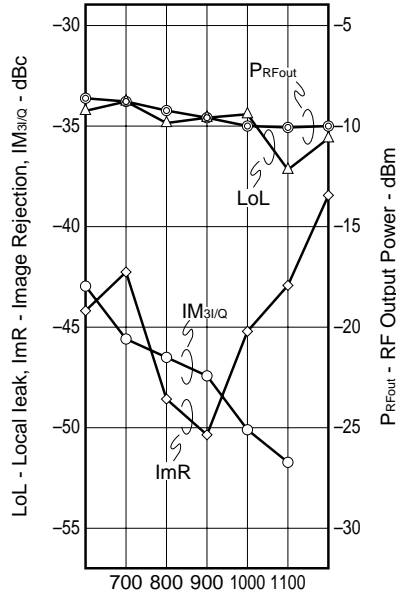

f_{lo} - Local Input Frequency - MHz

Lo INPUT FREQUENCY vs
 P_{RFout} , LoL, ImR, $IM_{3/1Q}$
 (at $V_{CC} = 3.6\text{ V}$, $T_A = -40\text{ }^\circ\text{C}$)

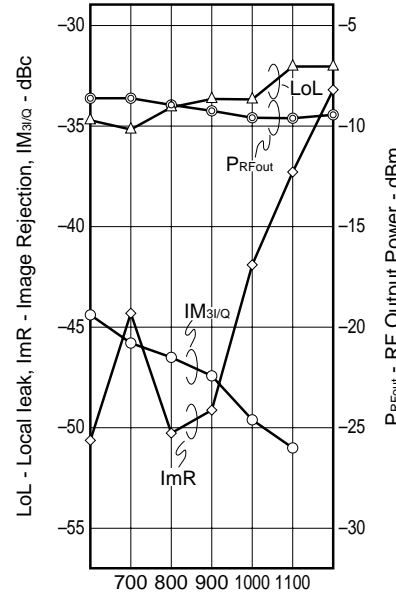

f_{lo} - Local Input Frequency - MHz

Lo INPUT FREQUENCY vs
 P_{RFout} , LoL, ImR, $IM_{3/1Q}$
 (at $V_{CC} = 2.7\text{ V}$, $T_A = +25\text{ }^\circ\text{C}$)

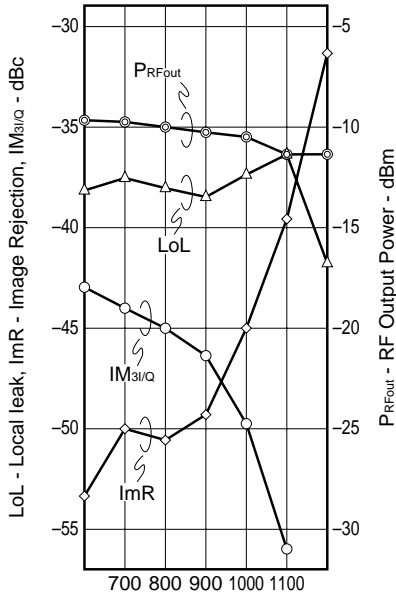

f_{lo} - Local Input Frequency - MHz

Lo INPUT FREQUENCY vs
 P_{RFout} , LoL, ImR, $IM_{3/1Q}$
 (at $V_{CC} = 3.0\text{ V}$, $T_A = +25\text{ }^\circ\text{C}$)

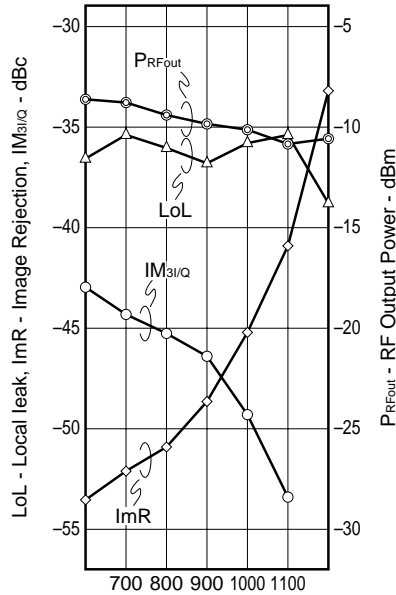

f_{lo} - Local Input Frequency - MHz

Lo INPUT FREQUENCY vs
 P_{RFout} , LoL, ImR, $IM_{3/1Q}$
 (at $V_{CC} = 3.6\text{ V}$, $T_A = +25\text{ }^\circ\text{C}$)

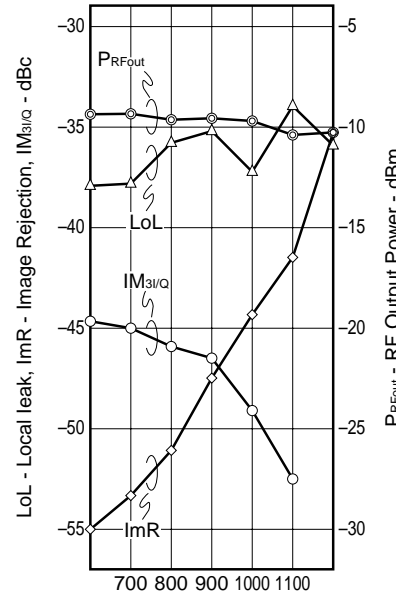

f_{lo} - Local Input Frequency - MHz

Lo INPUT FREQUENCY vs
P_{RFout}, LoL, ImR, IM_{3/1Q}
(at V_{CC} = 2.7 V, T_A = +85 °C)

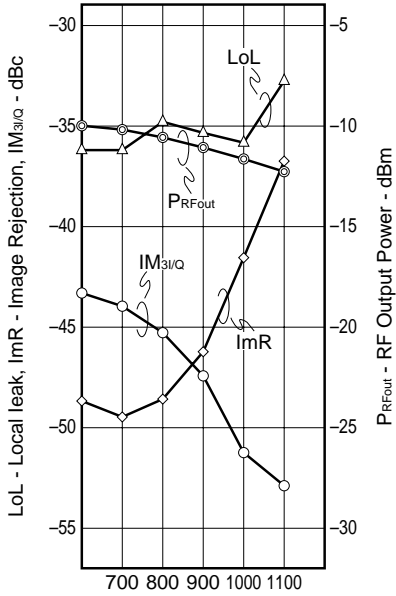

f_{lo} - Local Input Frequency - MHz

Lo INPUT FREQUENCY vs
P_{RFout}, LoL, ImR, IM_{3/1Q}
(at V_{CC} = 3.0 V, T_A = +85 °C)

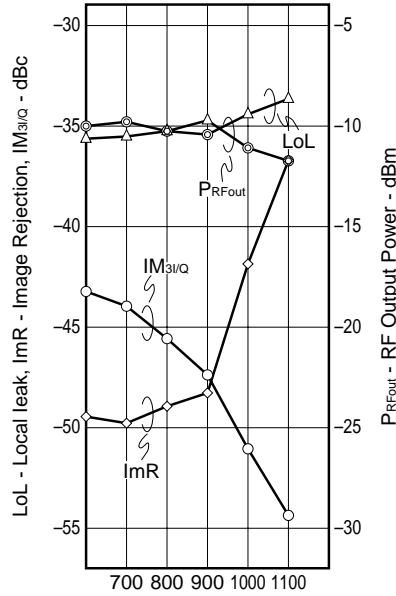

f_{lo} - Local Input Frequency - MHz

Lo INPUT FREQUENCY vs
P_{RFout}, LoL, ImR, IM_{3/1Q}
(at V_{CC} = 3.6 V, T_A = +85 °C)

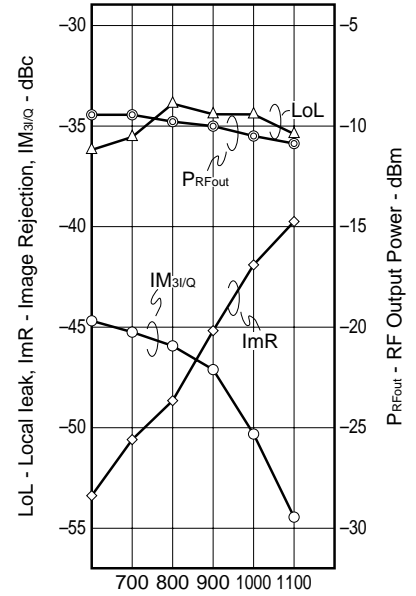

f_{lo} - Local Input Frequency - MHz

Lo INPUT POWER vs
P_{RFout}, LoL, ImR, IM_{3/1Q}
(at V_{CC} = 2.7 V, T_A = -40 °C)

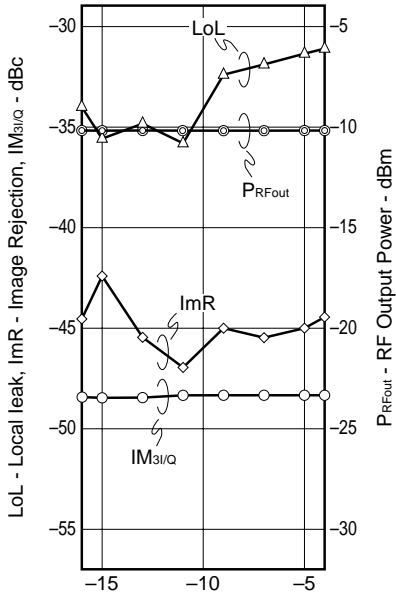

Lo - Local Input Power - dBm

Lo INPUT POWER vs
P_{RFout}, LoL, ImR, IM_{3/1Q}
(at V_{CC} = 3.0 V, T_A = -40 °C)

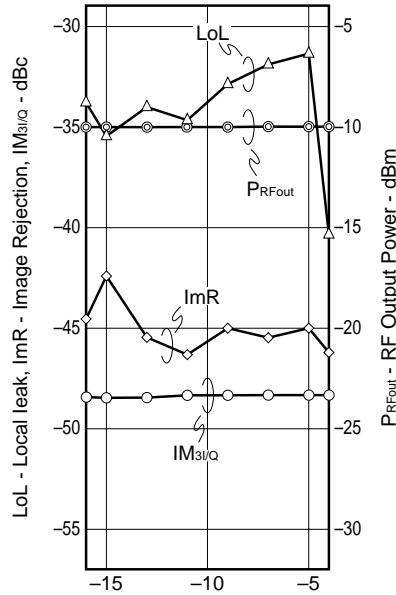

Lo - Local Input Power - dBm

Lo INPUT POWER vs
P_{RFout}, LoL, ImR, IM_{3/1Q}
(at V_{CC} = 3.6 V, T_A = -40 °C)

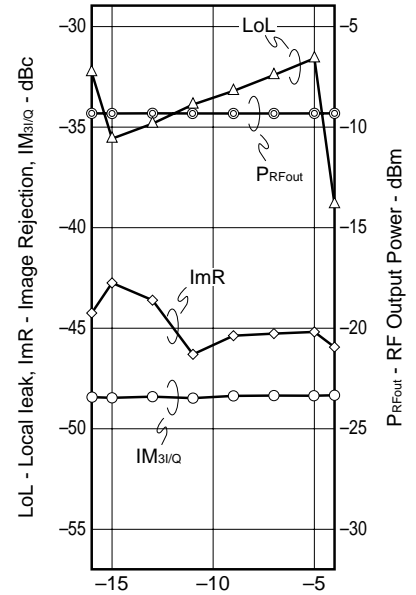

Lo - Local Input Power - dBm

Lo INPUT POWER vs
P_{RFout}, LoL, ImR, IM_{3I/Q}
(at V_{cc} = 2.7 V, T_A = +25 °C)

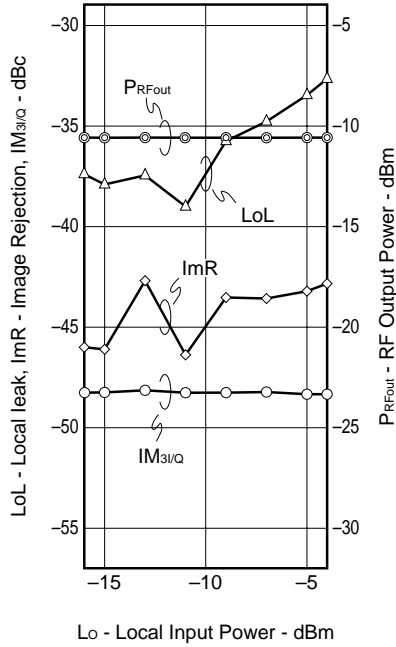

Lo INPUT POWER vs
P_{RFout}, LoL, ImR, IM_{3I/Q}
(at V_{cc} = 3.0 V, T_A = +25 °C)

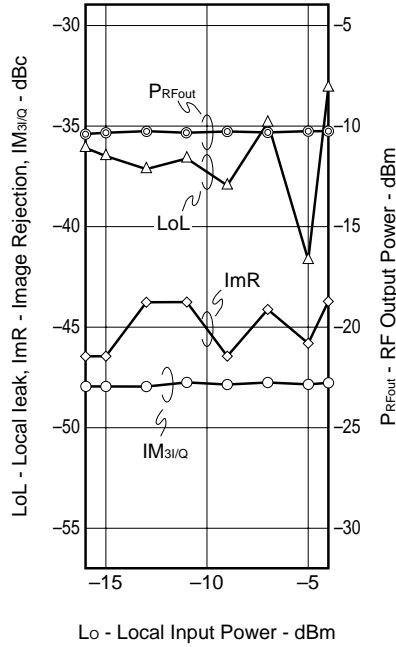

Lo INPUT POWER vs
P_{RFout}, LoL, ImR, IM_{3I/Q}
(at V_{cc} = 3.6 V, T_A = +25 °C)

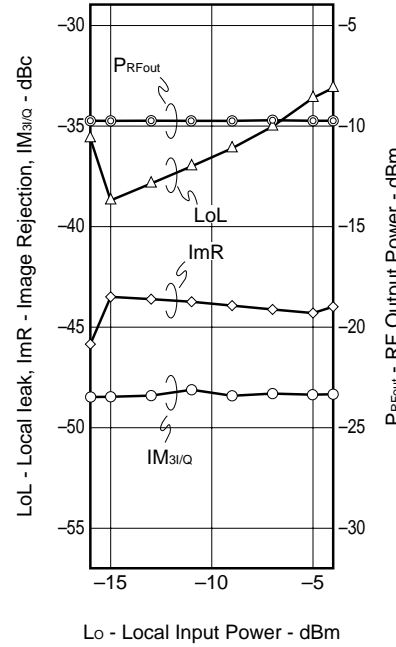

Lo INPUT POWER vs
P_{RFout}, LoL, ImR, IM_{3I/Q}
(at V_{cc} = 2.7 V, T_A = +85 °C)

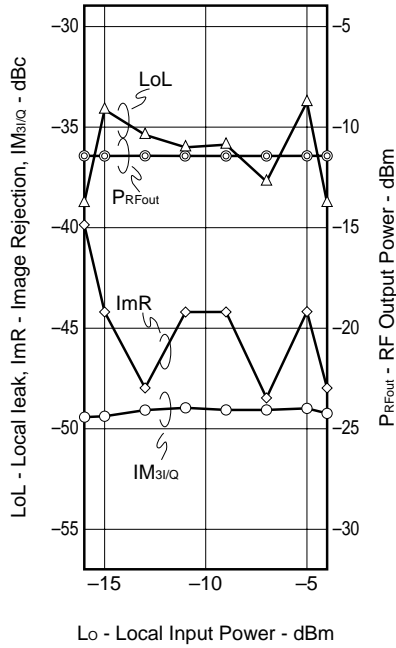

Lo INPUT POWER vs
P_{RFout}, LoL, ImR, IM_{3I/Q}
(at V_{cc} = 3.0 V, T_A = +85 °C)

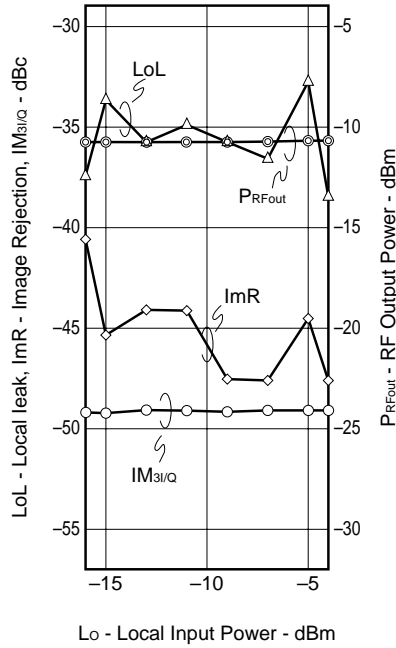

Lo INPUT POWER vs
P_{RFout}, LoL, ImR, IM_{3I/Q}
(at V_{cc} = 3.6 V, T_A = +85 °C)

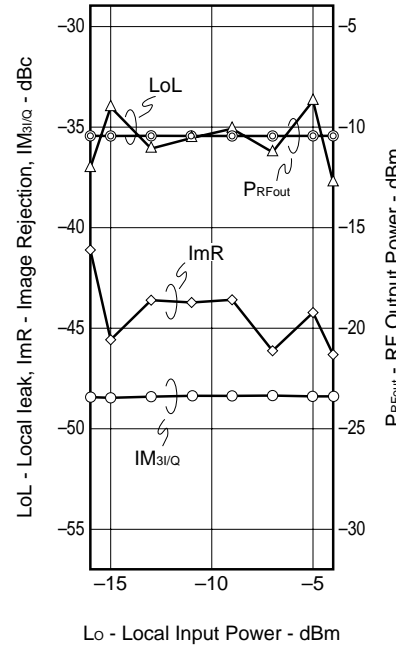

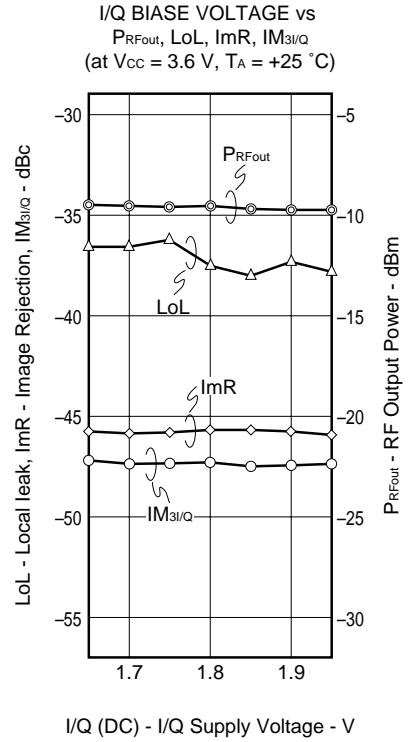
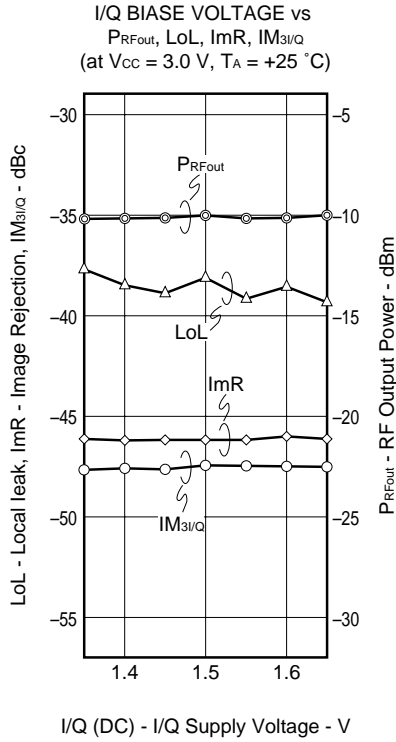
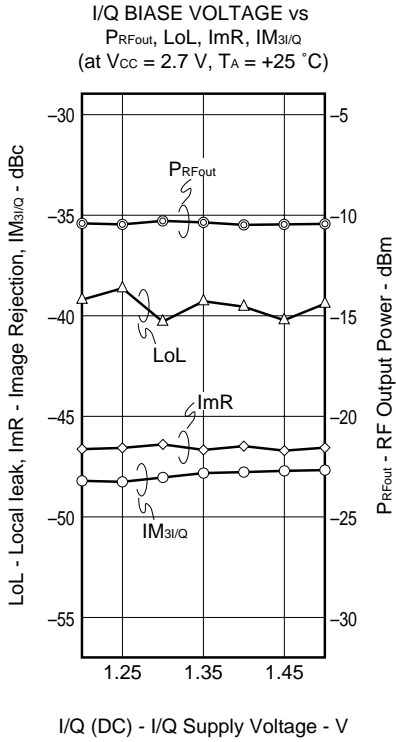
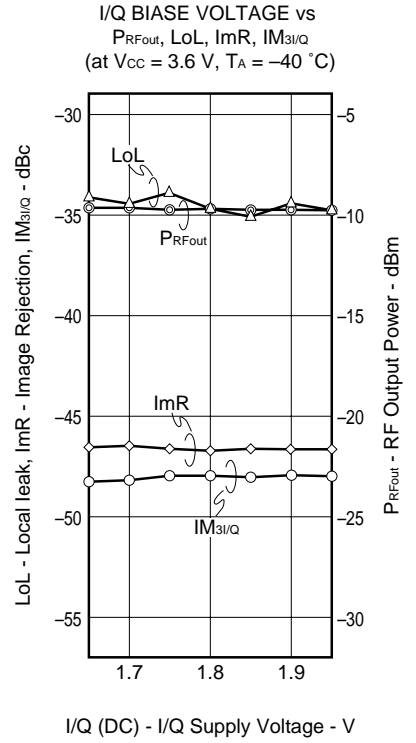
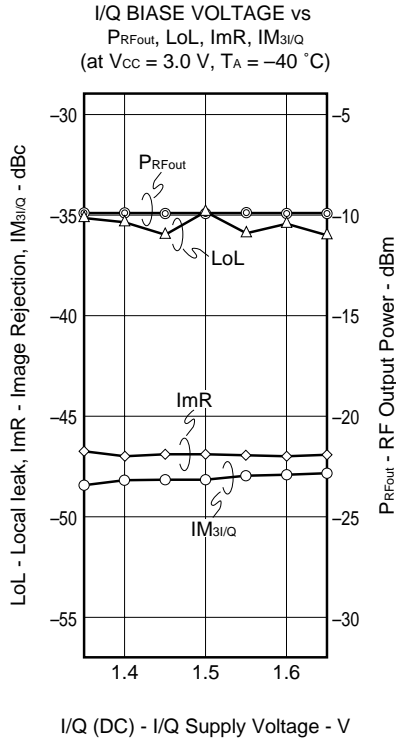
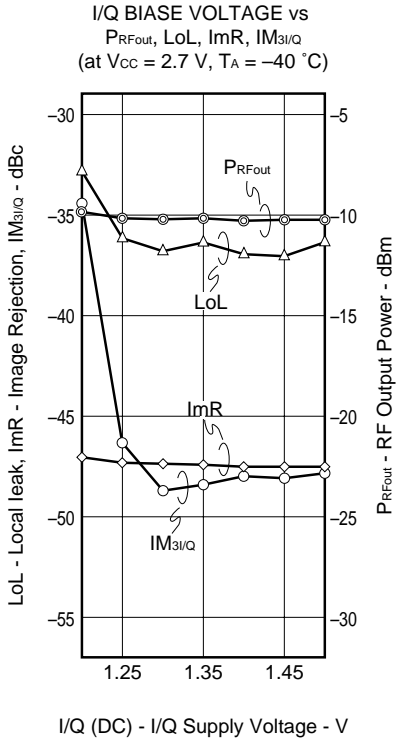

I/Q BIASE VOLTAGE vs
 P_{RFout} , LoL, ImR, $IM_{3/1Q}$
 (at $V_{CC} = 2.7\text{ V}$, $T_A = +85\text{ }^\circ\text{C}$)

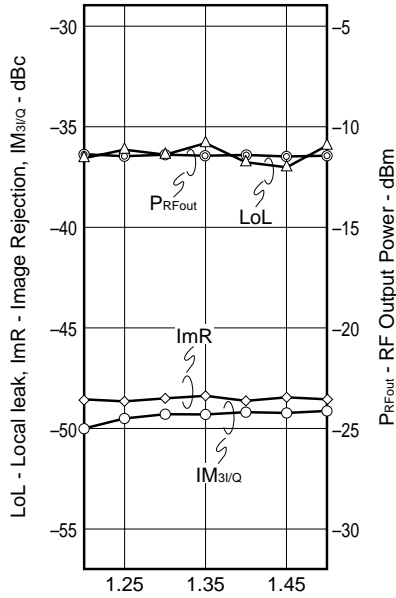

I/Q (DC) - I/Q Supply Voltage - V

I/Q BIASE VOLTAGE vs
 P_{RFout} , LoL, ImR, $IM_{3/1Q}$
 (at $V_{CC} = 3.0\text{ V}$, $T_A = +85\text{ }^\circ\text{C}$)

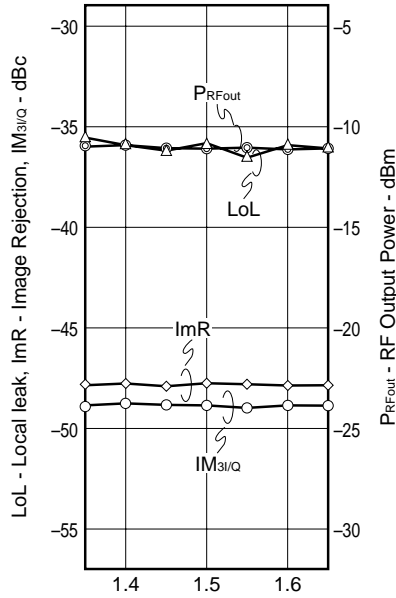

I/Q (DC) - I/Q Supply Voltage - V

I/Q BIASE VOLTAGE vs
 P_{RFout} , LoL, ImR, $IM_{3/1Q}$
 (at $V_{CC} = 3.6\text{ V}$, $T_A = +85\text{ }^\circ\text{C}$)

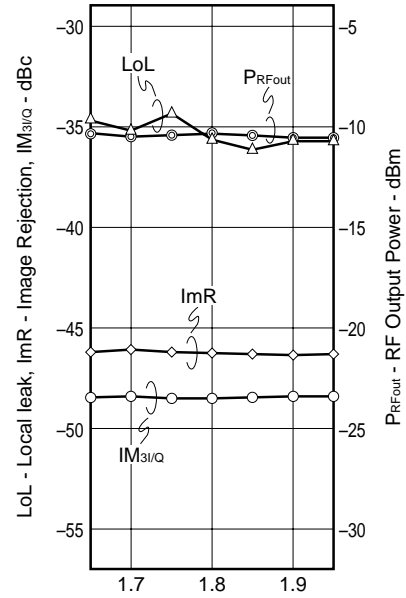

I/Q (DC) - I/Q Supply Voltage - V

TYPICAL SINE WAVE MODULATION OUTPUT SPECTRUM
 <PDC> 42 kbps, RNYQ $\alpha = 0.5$, MOD Pattern [0000]

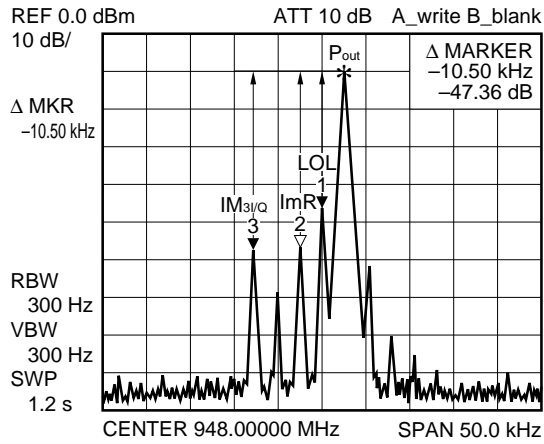

TYPICAL $\pi/4$ DQPSK MODULATION OUTPUT SPECTRUM
 <PDC> 42 kbps, RNYQ $\alpha = 0.5$, MOD Pattern [PN9]

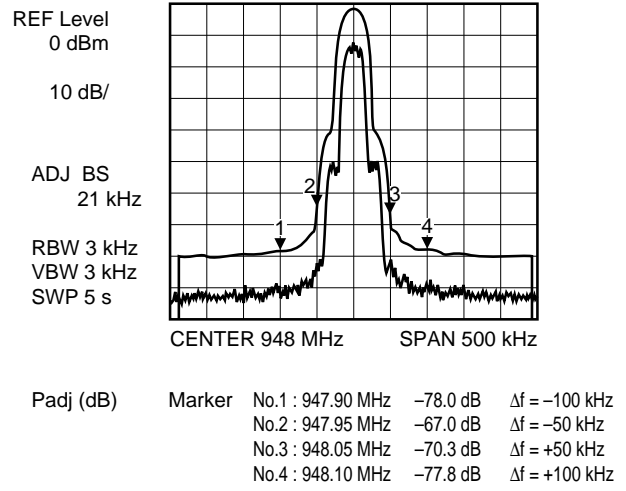

POWER SAVE RESPONSE
(at $V_{CC} = V_{PS} = 2.7\text{ V}$)

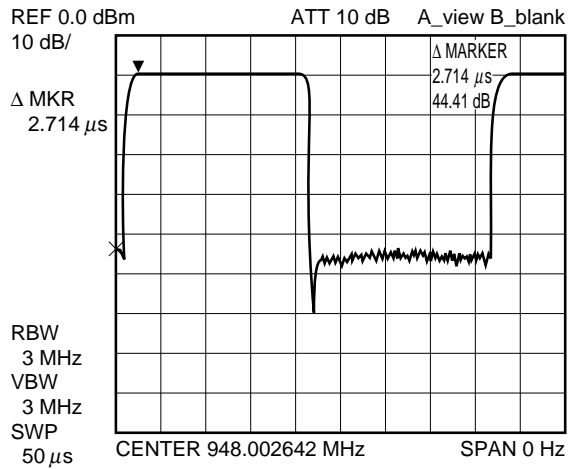

POWER SAVE RESPONSE
(at $V_{CC} = V_{PS} = 3.0\text{ V}$)

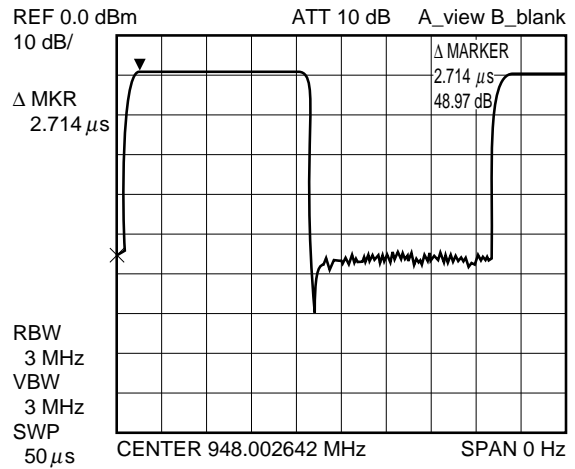

POWER SAVE RESPONSE
(at $V_{CC} = V_{PS} = 3.6\text{ V}$)

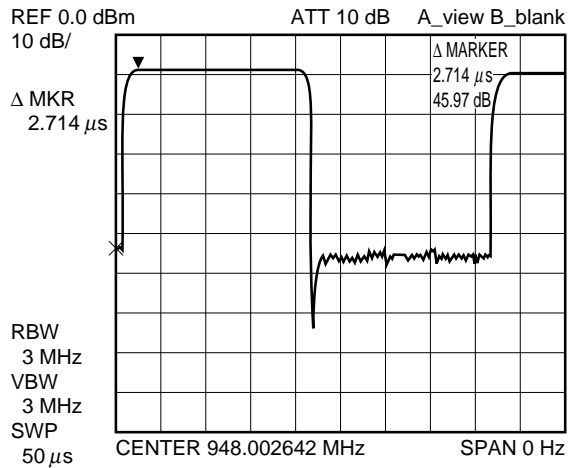

Lo INPUT (Lo_{in}) IMPEDANCE

V_{CC} = V_{PS} = 2.7 V

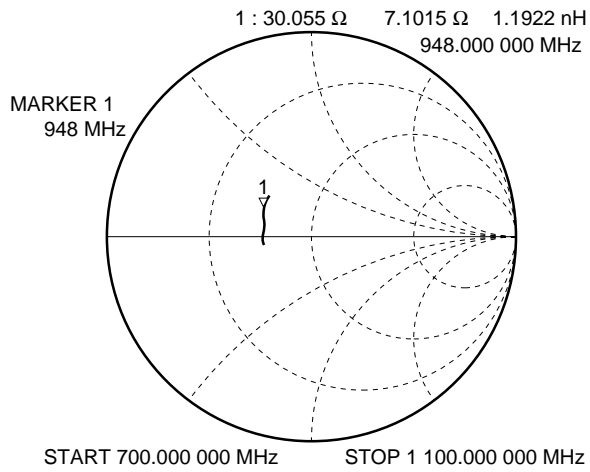

V_{CC} = V_{PS} = 3.0 V

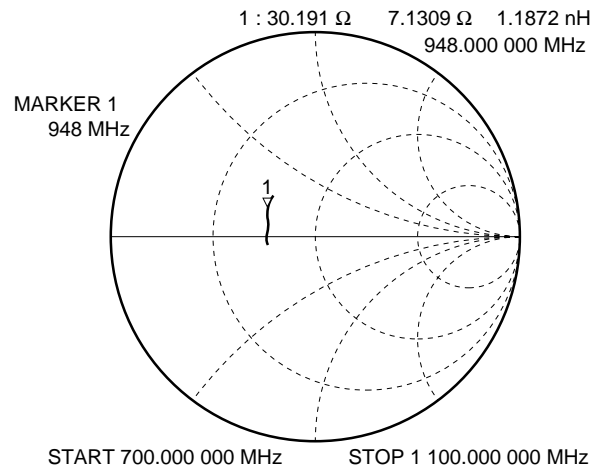

V_{CC} = V_{PS} = 3.6 V

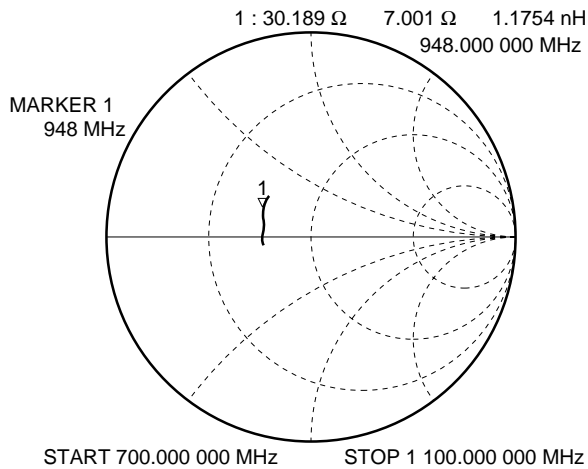

RF OUTPUT (RF_{out}) IMPEDANCE

V_{CC} = V_{PS} = 2.7 V

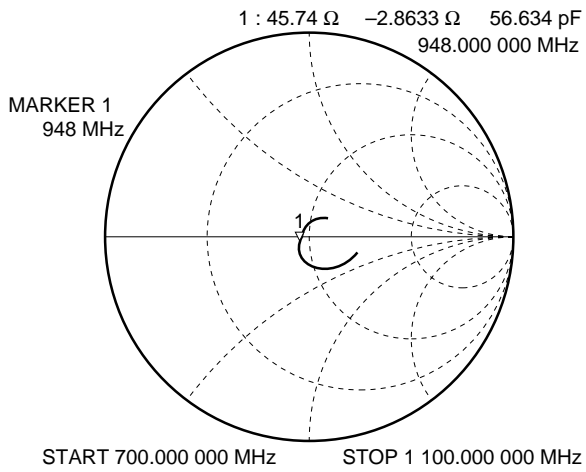

V_{CC} = V_{PS} = 3.0 V

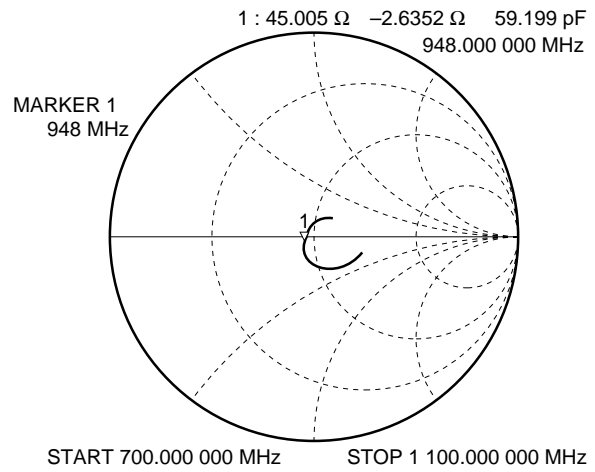

V_{CC} = V_{PS} = 3.6 V

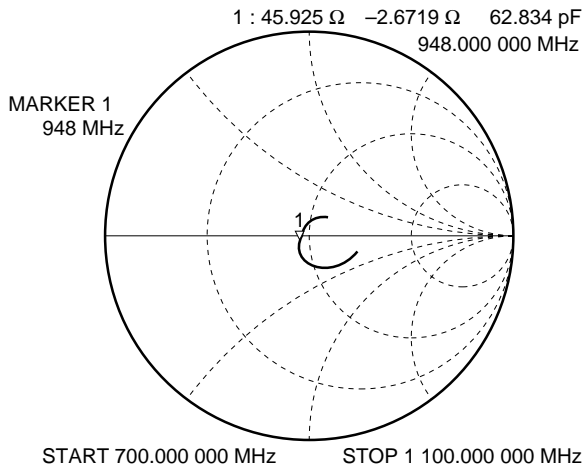

TEST CIRCUIT

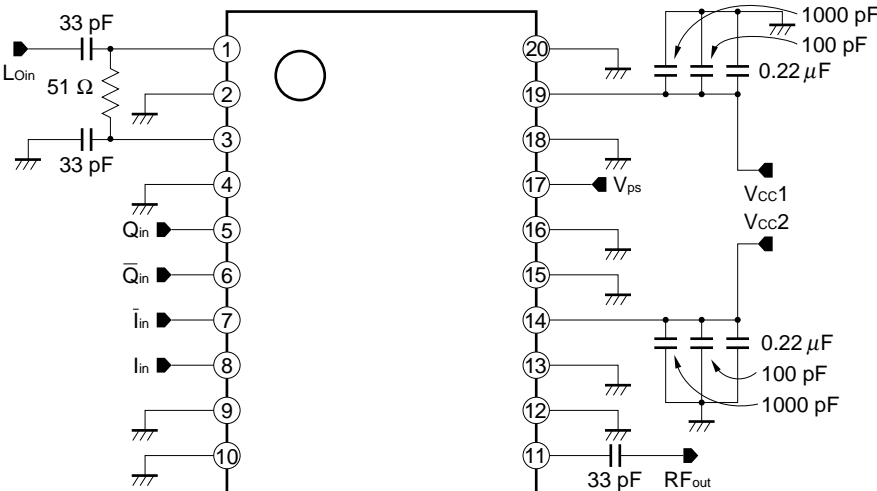

MEASUREMENT BLOCK DIAGRAM 1

(RF Output Power, Local Carrier Leak, Image Rejection, I/Q 3rd Order Intermodulation Distortion and Power Save Rise and Fall Time)

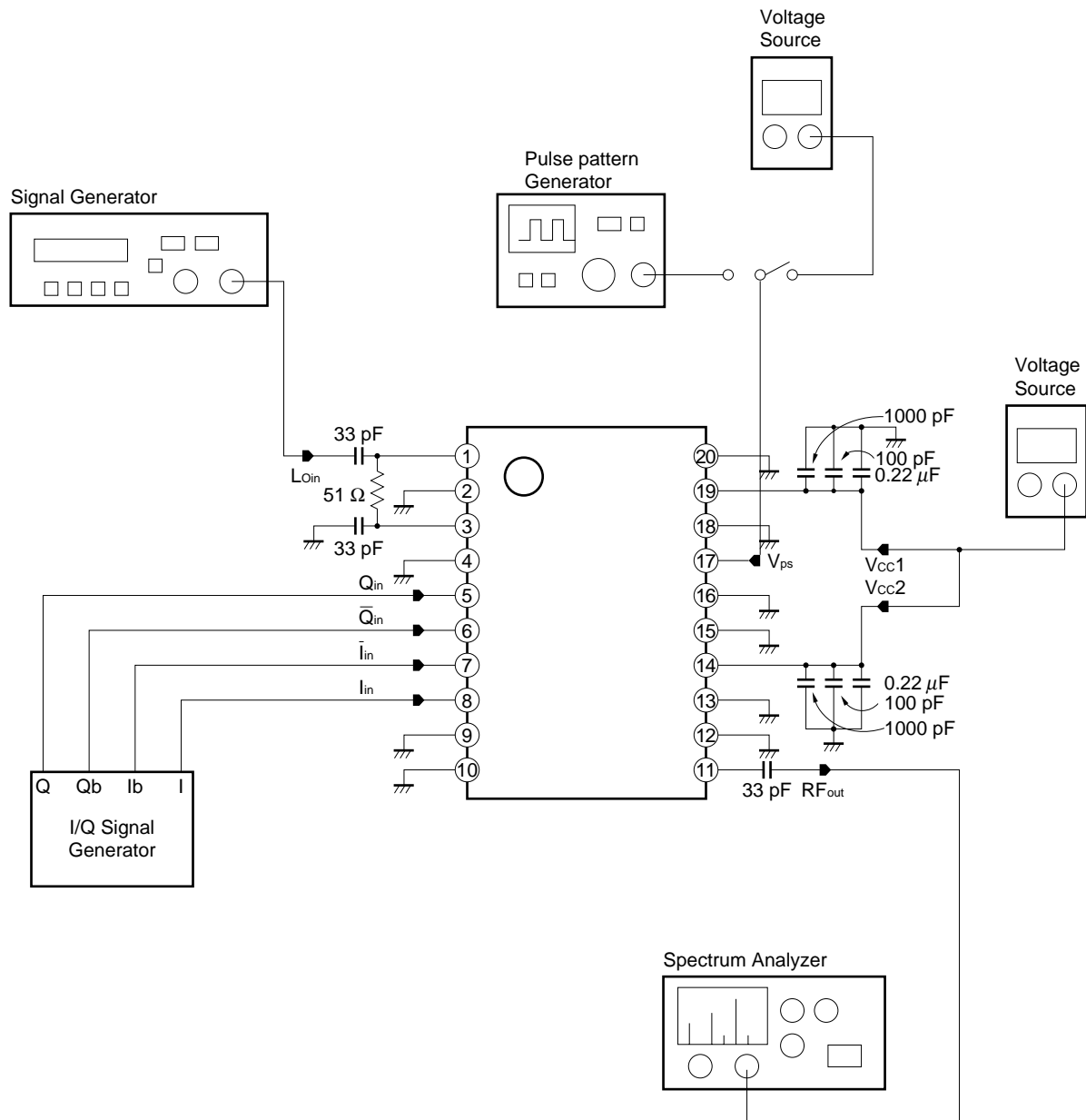

MEASUREMENT BLOCK DIAGRAM 2

(Local Input VSWR and RF Output VSWR)

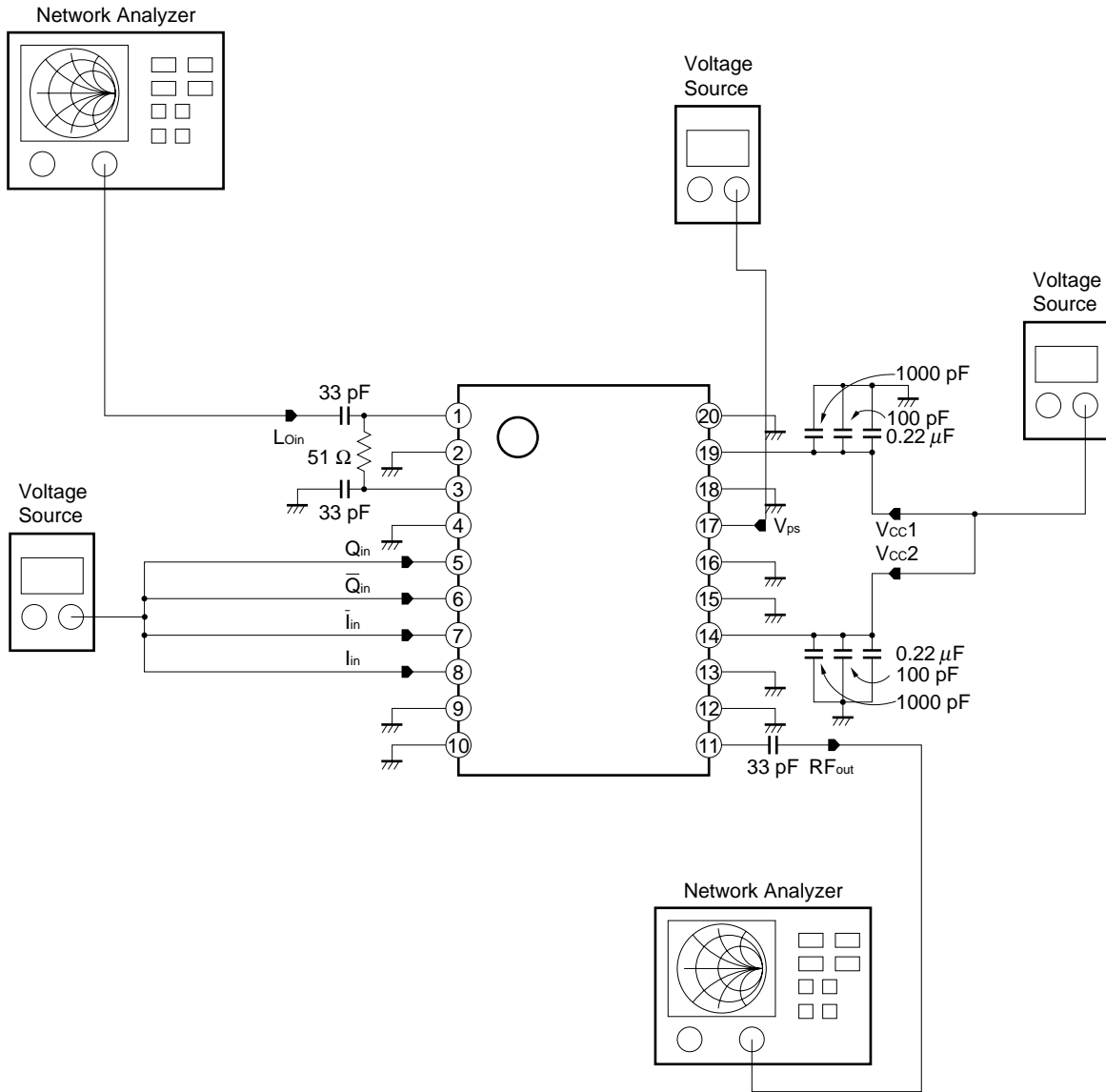

TEST BOARD

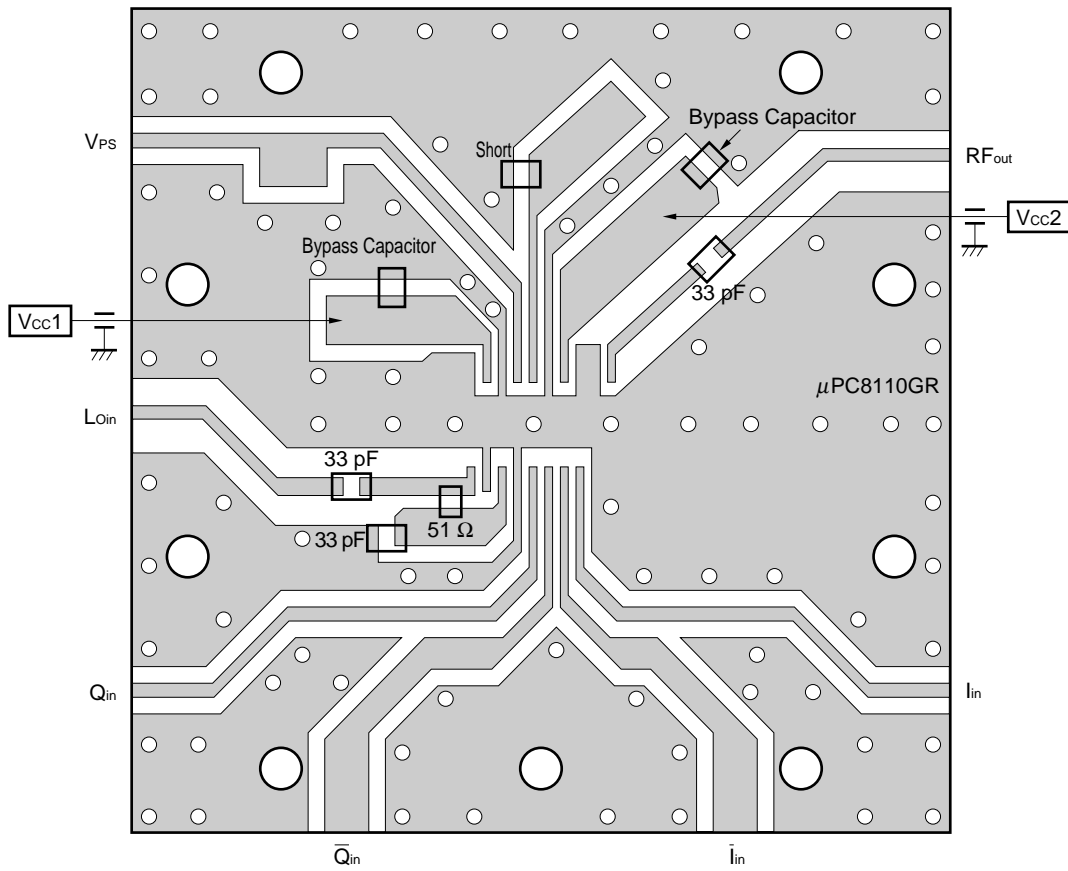

- Notes
1. Double-sided patterning with 35 μ m thick copper on polyimide board sizing 50 \times 50 \times 0.4 mm.
 2. GND pattern on backside.
 3. Solder coating over patterns.
 4. \circ , \bigcirc indicate through-holes.

PACKAGE DIMENSIONS

★ 20 PIN PLASTIC SSOP (225 mil) (UNIT: mm)

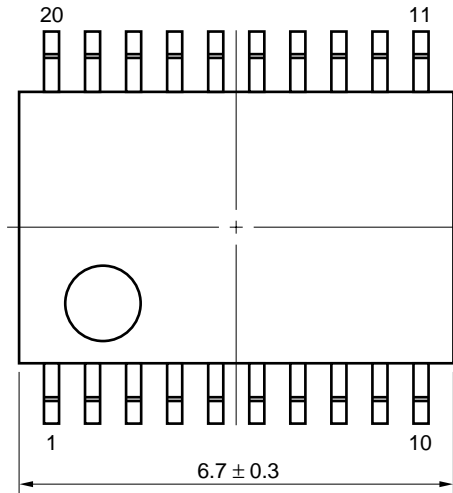

detail of lead end

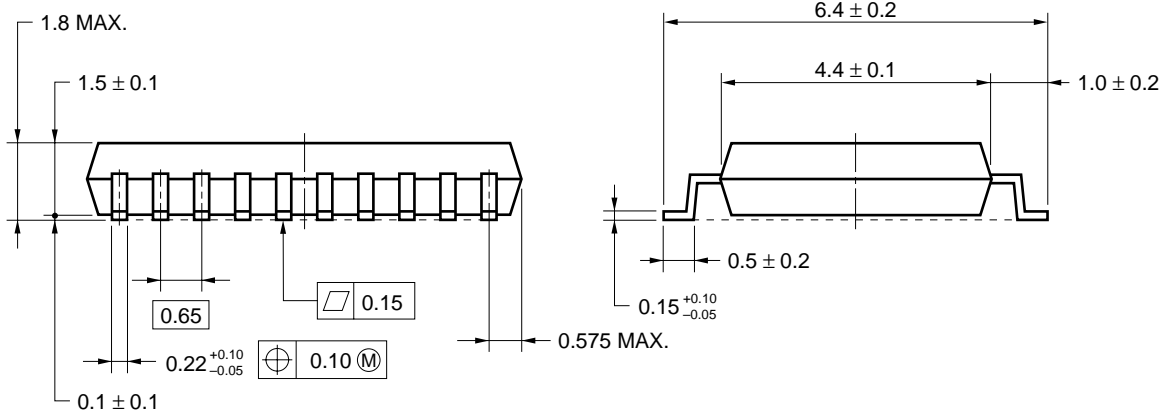
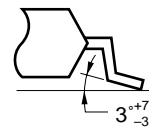

NOTE Each lead centerline is located within 0.10 mm of its true position (T.P.) at maximum material condition.

NOTE ON CORRECT USE

- (1) Observe precautions for handling because of electrostatic sensitive devices.
- (2) Form a ground pattern as wide as possible to keep the minimum ground impedance (to prevent undesired oscillation).
- (3) Keep the track length of the ground pins as short as possible.
- (4) Connect a bypass capacitor (e.x. 1 000 pF) to the V_{CC} pin.
- (5) I, Q DC offset voltage should be same as the I, Q DC offset voltage (to prevent changing the local leak level with power save control.)

RECOMMENDED SOLDERING CONDITIONS

This product should be soldered in the following recommended conditions. Other soldering method and conditions than the recommended conditions are to be consulted with our sales representatives.

μPC8110GR

Soldering process	Soldering conditions	Symbol
Infrared ray reflow	Peak package's surface temperature: 235 °C or below, Reflow time: 30 seconds or below (210 °C or higher), Number of reflow process: 3, Exposure limit ^{Note} : None	IR35-00-3
VPS	Peak package's surface temperature: 215 °C or below, Reflow time: 40 seconds or below (200 °C or higher), Number of reflow process: 3, Exposure limit ^{Note} : None	VP15-00-3
Wave soldering	Solder temperature: 260 °C or below, Flow time: 10 seconds or below, Number of flow process: 1, Exposure limit ^{Note} : None	WS60-00-1
Partial heating method	Terminal temperature: 300 °C or below, Flow time: 3 seconds/pin or below, Exposure limit ^{Note} : None	

Note Exposure limit before soldering after dry-pack package is opened.
Storage conditions: 25 °C and relative humidity at 65 % or less.

Caution Apply only a single process at once, except for "Partial heating method".

For details of recommended soldering conditions for surface mounting, refer to information document SEMICONDUCTOR DEVICE MOUNTING TECHNOLOGY MANUAL (C10535E).

[MEMO]

[MEMO]

[MEMO]

- **The information in this document is subject to change without notice. Before using this document, please confirm that this is the latest version.**
 - No part of this document may be copied or reproduced in any form or by any means without the prior written consent of NEC Corporation. NEC Corporation assumes no responsibility for any errors which may appear in this document.
 - NEC Corporation does not assume any liability for infringement of patents, copyrights or other intellectual property rights of third parties by or arising from use of a device described herein or any other liability arising from use of such device. No license, either express, implied or otherwise, is granted under any patents, copyrights or other intellectual property rights of NEC Corporation or others.
 - Descriptions of circuits, software, and other related information in this document are provided for illustrative purposes in semiconductor product operation and application examples. The incorporation of these circuits, software, and information in the design of the customer's equipment shall be done under the full responsibility of the customer. NEC Corporation assumes no responsibility for any losses incurred by the customer or third parties arising from the use of these circuits, software, and information.
 - While NEC Corporation has been making continuous effort to enhance the reliability of its semiconductor devices, the possibility of defects cannot be eliminated entirely. To minimize risks of damage or injury to persons or property arising from a defect in an NEC semiconductor device, customers must incorporate sufficient safety measures in its design, such as redundancy, fire-containment, and anti-failure features.
 - NEC devices are classified into the following three quality grades:
"Standard", "Special", and "Specific". The Specific quality grade applies only to devices developed based on a customer designated "quality assurance program" for a specific application. The recommended applications of a device depend on its quality grade, as indicated below. Customers must check the quality grade of each device before using it in a particular application.
 - Standard: Computers, office equipment, communications equipment, test and measurement equipment, audio and visual equipment, home electronic appliances, machine tools, personal electronic equipment and industrial robots
 - Special: Transportation equipment (automobiles, trains, ships, etc.), traffic control systems, anti-disaster systems, anti-crime systems, safety equipment and medical equipment (not specifically designed for life support)
 - Specific: Aircraft, aerospace equipment, submersible repeaters, nuclear reactor control systems, life support systems or medical equipment for life support, etc.
- The quality grade of NEC devices is "Standard" unless otherwise specified in NEC's Data Sheets or Data Books. If customers intend to use NEC devices for applications other than those specified for Standard quality grade, they should contact an NEC sales representative in advance.