

MOS INTEGRATED CIRCUIT

μ PD17006AGF-011

4-BIT SINGLE-CHIP MICROCONTROLLER WITH PRESCALER, PLL FREQUENCY SYNTHESIZER, AND IF COUNTER FOR AUTOMOBILE FM, MW, AND LW RADIOS

DESCRIPTION

The μ PD17006AGF-011 is a 4-bit CMOS microcontroller for digital tuning and can receive European FM, MW, and LW bands. It contains a prescaler (150 MHz MAX.), PLL frequency synthesizer, and IF counter.

This microcontroller supports European Radio Data System (RDS) and implements various RDS functions, so that it can configure with a single chip a high-performance FM, MW, or LW tuner such as that for luxury automobile stereo systems.

In addition, an RDS decoder is realized as a software library, so that the system using the μ PD17006AGF-011 can eliminate one IC chip as compared with existing systems.

FEATURES

- Preset memory
 - Five stations each for four bands, FM1, FM2, FM3, and AM (shared with MW and LW), totaling 20 stations
- Last channel memory
 - One station for each band
- Tuning function
 - Manual seek/auto seek
 - Auto store memory
 - Auto retune
- μ PD16430A as LCD controller/driver
- 5 V \pm 10% single power source
- RDS function
 - Broadcasting station name display (PS)
 - AF operation
 - AF list of up to 25 stations can be loaded.
 - Supports METHOD A/B
 - Traffic information standby function (TP, TA)
 - Alarm function (PTY = 31)
 - PTY seek function (broadcasting program identification information)
 - CT function (time adjustment function)
 - RDS memory
 - AF data for eight stations can be stored for 22 types of PI codes.
 - EON function
 - RDS memory AF data update function
 - EON station traffic information selection function
 - RDS decode function

ORDERING INFORMATION

Part number	Package	Quality grade
μ PD17006AGF-011-3B9	80-pin plastic QFP (14 × 20 mm)	Standard

Please refer to "Quality grade on NEC Semiconductor Devices" (Document number IEI-1209) published by NEC Corporation to know the specification of quality grade on the devices and its recommended applications.

The information in this document is subject to change without notice.

FUNCTIONAL OUTLINE

Receive frequency, channel space, reference frequency, intermediate frequency

Parameter Band	Receive frequency	Channel space	Reference frequency	Intermediate frequency
FM	87.50-108.00 MHz	50 kHz	50 kHz	10.7 MHz
MW	522-1620 kHz	9 kHz	9 kHz	450 kHz 459 kHz 10.71 MHz
LW	144-281 kHz	1 kHz	1 kHz	450 kHz 459 kHz 10.71 MHz

Station selection function

(1) Manual tuning

Type	Description
Manual up Manual down	Increases or decreases frequency by 1 step each time key is pressed. If key is held down for 0.5 second or longer, frequency is increased/decreased rapidly until key is released.

(2) Auto tuning

Type	Description
Seek up Seek down	Searches station in up or down direction. When station is found, its frequency is held (seek operation is performed in 100-kHz steps in FM band). Only RDS stations are searched for in RDS mode. Only traffic information station is searched for in TP/SK mode.

(3) Preset memory

Five stations can be stored for each of the four bands (FM1, FM2, FM3, and AM). Therefore, up to 20 stations can be stored. The AM band is shared with MW and LW bands.

(4) Preset memory scan

The contents of the FM1, FM2, FM3, and AM preset memories can be received independently for about 5 seconds each.

(5) Auto store memory

Stations can be searched starting from the minimum frequency. When stations are found, they are written to the preset memories starting from the one with the highest signal meter level. The stations are then sorted in the order of frequency.

(6) Last channel memory

One station of last channel memory is provided independently for each of FM1, FM2, FM3, and AM.

(7) Auto retune

If the SD signal cannot be detected for about 20 seconds while a station is being received, tuning is automatically started.

RDS function**(1) Broadcasting station display**

The name of the broadcasting station currently being received is displayed by using a PS code.

(2) AF operation

An AF list of up to 25 stations can be loaded, with METHOD A and METHOD B supported. Loading of AFs of other stations by EON is also supported.

(3) Traffic information station selection

TA and TP bits are detected in TP/SK standby status and a traffic information station is selected. This function supports EON.

(4) Time adjustment

The internal timer is adjusted by using CT code.

(5) Alarm

When the PTY alarm code (=31) is received, the sound is changed to the radio.

(6) RDS memories

Up to 22 types of PI codes can be stored in the RDS memories. The memory of each PI code stores eight stations from the corresponding AF lists.

(7) Broadcasting program identification information

By using PTY codes 0 to 15, the name of the broadcasting program currently being received can be displayed. In addition, searching by using the displayed program name can be performed.

Timer function

- (1) 12-hour display (with "FM" and "FM" displayed) and 24-hour display
- (2) Flashing (1 Hz) of the colon (":") can be enabled or disabled.
- (3) Low-current backup is possible in non-timer mode.

Tape function

- (1) Sound selection can be made by tape signal input.
- (2) Tape running direction can be displayed.
- (3) Noise reduction output can be performed.

CD function

- (1) Sound selection can be performed by CD signal input.
- (2) Sound selection can be performed by CD key.

PIN CONFIGURATION (Top View)

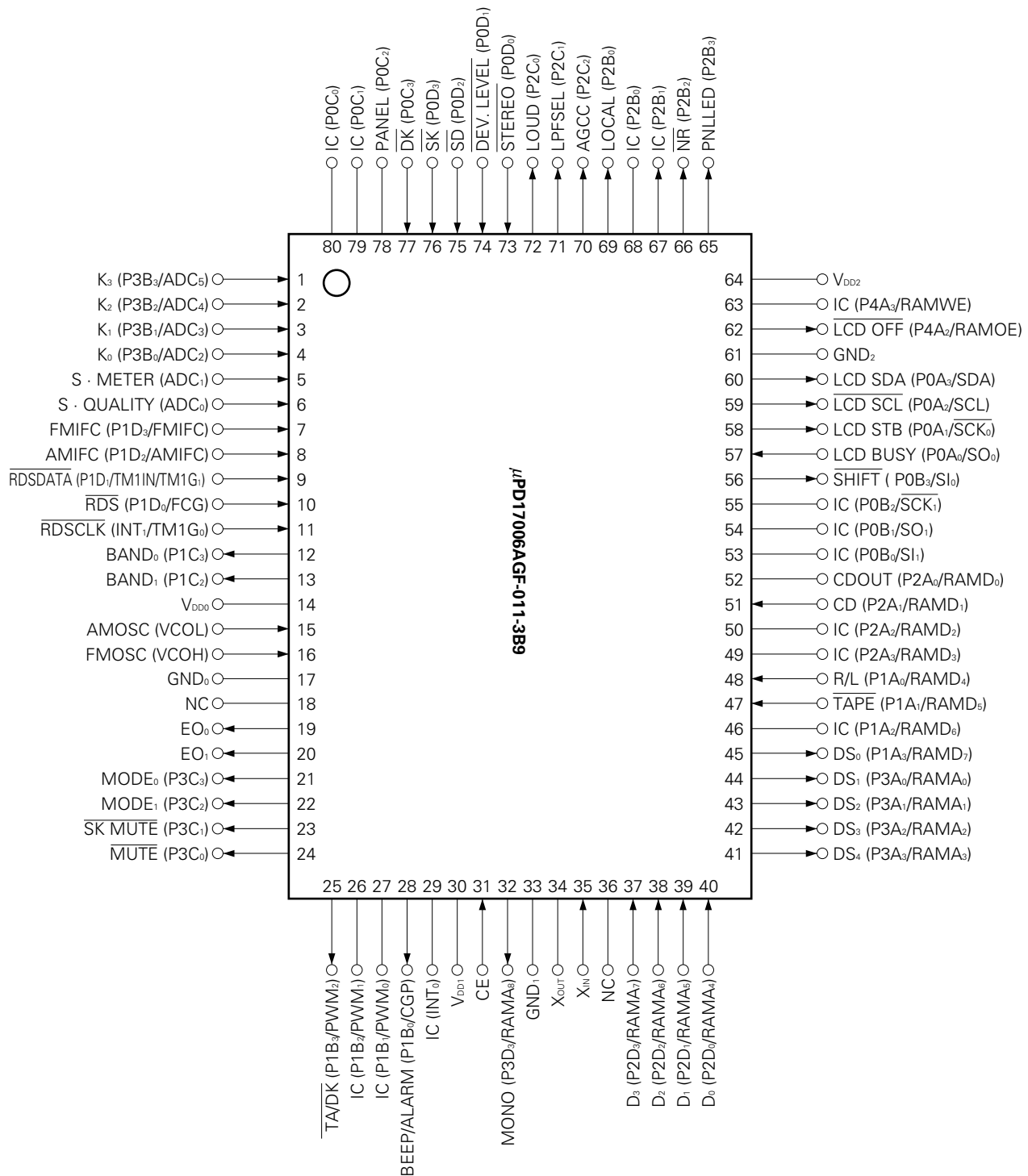

Remark () : μPD17006AGF

TABLE OF CONTENTS

1.	PIN FUNCTIONS	7
2.	KEY MATRIX CONFIGURATION	14
2.1	Analog Key Matrix Configuration	14
2.1.1	Voltage range of analog key matrix	14
2.1.2	Example of calculating analog key resistance	14
2.1.3	Analog key matrix when FUNC = 0	15
2.1.4	Analog key matrix when FUNC = 1	15
2.2	Description of Analog Key Matrix	16
2.3	Layout of Initial Setting Diode Matrix	28
2.4	Connection of Initial Setting Diode Matrix	29
2.5	Description of Initial Setting Diode Matrix	30
3.	DATA OUTPUT TO LCD CONTROLLER/DRIVER (μPD16430A)	35
4.	RDS (Radio Data System) FUNCTION	37
4.1	RDS Data Processing	37
4.1.1	PI (Program Identification)	38
4.1.2	PS (Program Service Name)	39
4.1.3	PTY (Program Type)	39
4.1.4	AF (List of Alternative Frequency)	40
4.1.5	EON (Enhanced Other Network)	46
4.1.6	TP (Traffic Program Identification), TA (Traffic Announcement Identification)	47
4.1.7	CT (Clock-Time and Data)	49
5.	MODE TRANSITION	50
6.	LCD PANEL	51
6.1	LCD Panel	51
6.2	LCD Pin Assignment	52
6.3	Description of Display	54
7.	MUTE OUTPUT TIMING CHART	57
7.1	Preset Memory Read	57
7.2	Preset Scan	57
7.3	Seek up/down	58
7.4	Manual up/down	61
7.5	Auto Store Memory	62
7.6	On Selecting CE	63
7.7	On Selecting Sound Mode (selector)	64
7.8	On Turning ON/OFF Detachable Panel	65

8. APPLICATION CIRCUIT EXAMPLE	66
9. ELECTRICAL SPECIFICATIONS (PRELIMINARY)	67
10. PACKAGE DRAWING	70

1. PIN FUNCTIONS

Pin No.	Symbol	Pin Name	Function	I/O Format								
1 4	K ₃ K ₀	Key return signal inputs	Analog key return signal input pins. For connection of analog keys, refer to 2. KEY MATRIX CONFIGURATION.	Analog input								
5	S•METER	Signal meter signal input	Signal meter signal input pin. Input analog signal according to intensity of received electric field. This pin is used to judge condition for AF selection.	Analog input								
6	S•QUALITY	Signal quality signal input	Signal quality input pin. Input analog signal according to quality of received electric field. This pin is used to judge condition for AF selection.	Analog input								
7	FMIFC	FM intermediate frequency input	FM band intermediate frequency (IF) input pin. Because an on-chip AC amplifier is provided, cut DC component with a capacitor for input. This pin is used to detect presence/absence of broadcasting station during auto tuning when FM IF/SD switch of initial setting diode = 1 (shorted with diode). When it is judged that a station is present, input frequency and input conditions are as follows: <table border="1" data-bbox="721 972 1110 1056"> <thead> <tr> <th>Band</th> <th>Input frequency range</th> </tr> </thead> <tbody> <tr> <td>FM</td> <td>10.7 MHz ± 20.0 kHz</td> </tr> </tbody> </table> Input frequency range is range of frequencies that must be input within 10 ms after PLL is locked.	Band	Input frequency range	FM	10.7 MHz ± 20.0 kHz	Input				
Band	Input frequency range											
FM	10.7 MHz ± 20.0 kHz											
8	AMIFC	AM intermediate frequency input	This is the AM band (MW, LW) intermediate frequency (IF) input pin. Because an on-chip AC amplifier is provided, cut out the DC component with a capacitor in the input. This pin is used to detect presence/absence of broadcasting station during auto tuning when FM IF/SD switch of initial setting diode = 1 (shorted with diode). When it is judged that a station is present, input frequency and input conditions are as follows: <table border="1" data-bbox="721 1503 1151 1692"> <thead> <tr> <th>Band</th> <th>Input frequency range [kHz]</th> </tr> </thead> <tbody> <tr> <td rowspan="2">MW</td> <td>450 ± 3</td> </tr> <tr> <td>459 ± 3</td> </tr> <tr> <td rowspan="2">LW</td> <td>450 ± 3</td> </tr> <tr> <td>459 ± 3</td> </tr> </tbody> </table> Input frequency range is range of frequencies that must be input within 20 ms after PLL is locked.	Band	Input frequency range [kHz]	MW	450 ± 3	459 ± 3	LW	450 ± 3	459 ± 3	Input
Band	Input frequency range [kHz]											
MW	450 ± 3											
	459 ± 3											
LW	450 ± 3											
	459 ± 3											

Pin No.	Symbol	Pin Name	Function	I/O Format												
9	$\overline{\text{RDSDATA}}$	RDS data input	RDS data input pin. Input data signal from RDS signal detection block. Data is read at falling edge of RDS clock.	Input												
10	$\overline{\text{RDS}}$	RDS signal input	Input pin to detect RDS signal of RDS station. Used to prevent synchronization caused by station other than an RDS station. Input RDS data is valid when this pin is low. To synchronize with $\overline{\text{RDSDATA}}$ and $\overline{\text{RDSCLK}}$ only during auto tuning operation, pull down this pin.	Input												
11	$\overline{\text{RDSCLK}}$	RDS clock input	RDS clock input pin. Input clock signal from RDS signal detection block. Because the μPD17006AGF-011 does not detect bit synchronization by width of clock signal, input as accurate a clock as possible.	Input												
12 13	BAND ₀ BAND ₁	Band select signal outputs	Band select signal output pins. When received band is changed by band select key, output as follows in each band: <table border="1" style="margin: 10px auto;"> <thead> <tr> <th>Band \ Pin</th> <th>BAND₀</th> <th>BAND₁</th> </tr> </thead> <tbody> <tr> <td>MW</td> <td>0</td> <td>0</td> </tr> <tr> <td>LW</td> <td>0</td> <td>1</td> </tr> <tr> <td>FM</td> <td>1</td> <td>×</td> </tr> </tbody> </table> (0 : low level 1 : high level × : Don't care)	Band \ Pin	BAND ₀	BAND ₁	MW	0	0	LW	0	1	FM	1	×	CMOS push-pull output
Band \ Pin	BAND ₀	BAND ₁														
MW	0	0														
LW	0	1														
FM	1	×														
14 30 64	V _{DD0} V _{DD1} V _{DD2}	Power inputs	Device power supply pins. Supply 5 V ± 10 % to these pins when device operates. When timer is not used (when NOCLK switch of initial setting diode = 0 (open)), and if voltage applied to these pins is lowered to 2.2 V, data can be retained if CE pin (pin 31) is made low. If 0 to 4.1 V is supplied to these pins, data is initialized to initial value. At this time, keep time of raising voltage from 0 to 4.1 V within 500 ms. Be sure to connect V _{DD0} to V _{DD2} pins to same voltage.	—												
15	AMOSC	AM station oscillation input	This pin inputs local oscillation output (VCO output) of AM (MW, LW) band. Becomes active when MW and LW bands are received; otherwise, pulled down internally. Frequencies that can be input are 0.5 to 25 MHz (0.3 V _{p-p}). Because on-chip AC amplifier is provided, cut out DC component with capacitor.	Input												

Pin No.	Symbol	Pin Name	Function	I/O Format												
16	FMOSC	FM local oscillation input	This pin inputs local oscillation output (VCO output) of FM band. It becomes active when FM band is received; otherwise, it is internally pulled down. Input frequency ranges from 15 to 150MHz (0.3V _{p-p}). Because on-chip AC amplifier is provided, cut out DC component with a capacitor.	Input												
17 33 61	GND ₀ GND ₁ GND ₂	Ground	Ground pins. GND ₀ is ground of PLL, and GND ₁ and GND ₂ are grounds of digital circuits.	—												
18	NC	No connection	Connect nothing to this pin.	—												
19 20	EO ₀ EO ₁	Error out	These are output pins of charge pump of PLL (Phase Locked Loop). If divided local oscillation frequency (VCO output) is higher than reference frequency, these pins output high level; if local oscillation frequency is lower than reference frequency, these pins output low level. They are floated if two frequencies match. These outputs are input to external LPF (lowpass filter) and are applied to varactor diode via LPF. Same waveform is output to EO ₀ and EO ₁ . You can use either pin.	CMOS 3-state output												
21 22	MODE ₀ MODE ₁	Mode signal output	These pins indicate operation mode of μPD17006AGF-011, as follows: <table border="1" style="margin: 10px auto;"> <thead> <tr> <th>Mode₀</th> <th>MODE₁</th> <th>Mode</th> </tr> </thead> <tbody> <tr> <td>0</td> <td>0</td> <td>Radio</td> </tr> <tr> <td>1</td> <td>0</td> <td>Tape</td> </tr> <tr> <td>1</td> <td>1</td> <td>CD</td> </tr> </tbody> </table> (0: low level, 1: high level)	Mode ₀	MODE ₁	Mode	0	0	Radio	1	0	Tape	1	1	CD	CMOS push-pull output
Mode ₀	MODE ₁	Mode														
0	0	Radio														
1	0	Tape														
1	1	CD														
23	$\overline{\text{SK MUTE}}$	SK mute output signal	SK mute output pin used in absence of traffic information station identification signal in TP/SK mode.	CMOS push-pull output												
24	$\overline{\text{MUTE}}$	Mute signal output	Sound mute signal output pin. It is used to reject shock noise that is generated when PLL is unlocked in radio mode, or to select mode pin output. For output timing, refer to 7. MUTE OUTPUT TIMING CHART.	CMOS push-pull output												
25	$\overline{\text{TA/DK}}$	Traffic information station signal output	Traffic information station identification signal output pin. It goes low when: • SK or DK signal, TP or TA bit, or alarm is detected in TP/SK mode of FM band. • Traffic information alarm is output.	N-ch open drain output												
26 27	IC	Internally connected	Connect nothing to this pin.	—												

Pin No.	Symbol	Pin Name	Function	I/O Format
28	BEEP/ ALARM	Beep and traffic informa- tion alarm signal output	<p>Beep and traffic information alarm output pin.</p> <p>● Beep sound Outputs square wave with frequency of 2.25 kHz and duty factor of 50 % for about 40 ms. This time is equal to forward mute time. Beep sound is issued when:</p> <ul style="list-style-type: none"> • Analog key is pressed and tuning operation is started. • Hold of about 5 seconds ends during preset memory scan operation. • Data is written to preset memory. <p>When it is specified that beep sound is not to be issued (when BEEP switch of initial setting diode = 0 (open)), no sound is issued.</p> <p>● Traffic information alarm When traffic information station identification signal is missing for about 3 seconds after SK mute output in TP/SK or RDS+TP/SK mode of FM band, outputs alarm sound with frequency of 900 Hz intermittently for about 0.5 second. If this pin is not used, leave it open.</p>	N-ch open drain output
29	IC	Internally connected	Connect this pin to GND via pull-down resistor.	—
31	CE	Chip enable	<p>Device select signal input pin. Inputs high level when device performs normal operation (radio, tape, CD, and timer display). However, this pin does not accept high or low level of less than 111 μs. When this pin is low, all radio, tape, CD, and display are turned off and μPD17006AGF-011 is placed in backup status. When no-timer mode (NOCLK switch of initial setting diode = 0 (open)) is set, low power dissipation backup status can be set.</p>	Input
32	MONO	Monaural signal output	Tuner monaural signal output pin.	CMOS push-pull output
34 35	X _{OUT} X _{IN}	Crystal oscillator	<p>These pins connect crystal oscillator. Connect 4.5-MHz crystal oscillator. To use timer function, only accuracy of oscillation frequency affects accuracy of timer. Adjust oscillation frequency while observing PLL local oscillation frequency.</p>	—
36	NC	No connection	Connect nothing to this pin.	—

Pin No.	Symbol	Pin Name	Function	I/O Format						
37 40	D ₃ D ₀	Initial setting diode return signal input	Return signal input pins of initial setting diode matrix. These pins configure matrix with DS ₀ (pin 45) to DS ₄ (pin 41). For connection, refer to 2.4 Connection of Initial Setting Diode Matrix.	Input						
41 45	DS ₄ DS ₀	Initial setting diode source signal input	Source signal input pins of initial setting diode matrix.	CMOS push-pull output						
46	IC	Internally connected	Connect this pin to GND via pull-down resistor.	—						
47	$\overline{\text{TAPE}}$	Tape signal input	Tape signal input pin. When this pin goes low, sound source (mode output) is changed to tape.	Input						
48	R/L	Tape running signal output	Tape running signal input pin. Used for display on LCD panel. Input as follows: <table border="1" style="margin-left: auto; margin-right: auto;"> <thead> <tr> <th>R/L pin</th> <th>Tape running direction</th> </tr> </thead> <tbody> <tr> <td>0</td> <td>Left → right</td> </tr> <tr> <td>1</td> <td>Right → left</td> </tr> </tbody> </table> <p style="text-align: center;">(0: low level, 1: high level)</p>	R/L pin	Tape running direction	0	Left → right	1	Right → left	Input
R/L pin	Tape running direction									
0	Left → right									
1	Right → left									
49 50	IC	Internally connected	Connect this pin to GND via pull-down resistor.	—						
51	CD	CD play signal input	CD play signal input pin. When high level is input to this pin, sound source (mode output) is changed to CD.	Input						
52	CDOUT	CD mode signal output	CD mode request signal output pin. Outputs high level when CD mode is set.	CMOS push-pull output						
53 54 55	IC	Internally connected	Connect this pin to GND via pull-down resistor.	—						
56	$\overline{\text{SHIFT}}$	Shift output	This pin is used when LCDSEL of initial setting diode = 1 (shorted). Outputs low level when shift status is set by <table border="1" style="display: inline-table; vertical-align: middle;"><tr><td>SHIFT</td></tr></table> key.	SHIFT	CMOS push-pull output					
SHIFT										
57	LCD BUSY	μPD16430A busy signal input	Inputs busy signal output from LCD controller/driver μPD16430A.	Input						
58	LCD STB	μPD16430A strobe signal output	Outputs strobe signal to LCD controller/driver μPD16430A.	CMOS push-pull output						
59	$\overline{\text{LCD SCL}}$	μPD16430A serial clock signal output	Outputs serial clock signal to LCD controller/driver μPD16430A.	CMOS push-pull output						

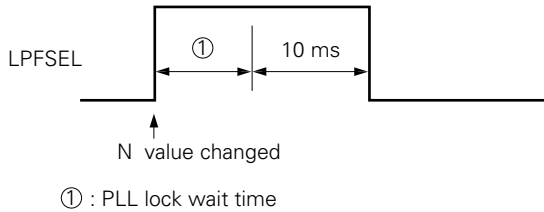
Pin No.	Symbol	Pin Name	Function	I/O Format						
60	LCD SDA	μPD16430A serial data signal output	Outputs serial data to LCD controller/driver μPD16430A.	CMOS push-pull output						
62	LCD OFF	LCD off output	Turns on/off display of LCD controller/driver μPD16430A.	CMOS push-pull output						
63	IC	Internally connected	Connect nothing to this pin.	—						
65	PNLLED	Panel detection LED signal output	Outputs LED signal indicating whether front panel is attached or detached. When front panel is detached, outputs signal of 1 Hz (1/2 duty cycle).	CMOS push-pull output						
66	NR	Noise reduction signal output	Noise reduction signal output pin. While "NR" blinks on LCD panel in tape mode, this pin outputs low level.	CMOS push-pull output						
67 68	IC	Internally connected	Connect nothing to this pin.	—						
69	LOCAL	Local output	LOCAL/DX select output of tuner.	CMOS push-pull output						
70	AGCC	AGCC output	Auto gain control cut signal output. Output during auto tuning.	CMOS push-pull output						
71	LPFSEL	LPF time constant select signal output	Outputs signal to select time constant of LPF of tuner during AF operation. This pin outputs high level during AF operation: 	CMOS push-pull output						
72	LOUD	Loudness output	Loudness output pin.	CMOS push-pull output						
73	STEREO	Stereo signal input	Stereo broadcasting signal input pin. Input as follows: <table border="1" data-bbox="667 1459 1127 1572"> <thead> <tr> <th>STEREO pin</th> <th>Description</th> </tr> </thead> <tbody> <tr> <td>0</td> <td>Stereo broadcasting</td> </tr> <tr> <td>1</td> <td>Monaural broadcasting</td> </tr> </tbody> </table> (0: low level, 1: high level) This pin is invalid in bands other than FM band.	STEREO pin	Description	0	Stereo broadcasting	1	Monaural broadcasting	Input
STEREO pin	Description									
0	Stereo broadcasting									
1	Monaural broadcasting									

Pin No.	Symbol	Pin Name	Function	I/O Format						
74	$\overline{\text{DEV.LEVEL}}$	Modulation level input	<p>Modulation level input pin.</p> <p>When starting AF operation with DEV.SEL switch of initial setting diode = 1 (shorted with diode), this pin is used to detect weakly modulated part (mute part), as follows:</p> <table border="1" style="margin-left: auto; margin-right: auto;"> <thead> <tr> <th>DEV.LEVEL</th> <th>Description</th> </tr> </thead> <tbody> <tr> <td>0</td> <td>Mute</td> </tr> <tr> <td>1</td> <td>Sound</td> </tr> </tbody> </table> <p>(0: low level, 1: high level)</p>	DEV.LEVEL	Description	0	Mute	1	Sound	Input
DEV.LEVEL	Description									
0	Mute									
1	Sound									
75	$\overline{\text{SD}}$	SD signal input	Broadcasting station detection signal input pin.	Input						
76	$\overline{\text{SK}}$	SK signal output	<p>Input pin that detects SK signal of VF broadcasting station. It is used as auto tuning stop signal. If low level is input to this pin within about 500 ms after broadcasting station has been detected, it is judged that a traffic information station was detected, and auto tuning is stopped.</p> <p>Pull up this pin when ARI is not used.</p>	Input						
77	$\overline{\text{DK}}$	DK signal input	<p>Input pin that detects DK signal of VF broadcasting station. It is judged that traffic information is being broadcast and standby mode is set if both SK (pin 76) and DK pin go low in standby mode.</p> <p>If DK pin goes high, standby mode is set again.</p> <p>Pull up this pin when ARI is not used.</p>	Input						
78	PANEL	Panel detection input pin	This pin indicates whether front panel is attached or detached. When this pin goes high, it indicates that front panel is detached.	Input						
79 80	IC	Internally connected	Connect this pin to GND via pull-down resistor.	—						

2. KEY MATRIX CONFIGURATION

2.1 Analog Key Matrix Configuration

2.1.1 Voltage range of analog key matrix

Table 2-1 shows the voltage range of the analog key matrix.

Table 2-1 Voltage Range of Analog Key Matrix

	Input Voltage Range (V)	Input A/D Value
Voltage range 1	0 to 0.9	00H-2EH
Voltage range 2	up to 1.6	2FH-52H
Voltage range 3	up to 2.35	53H-78H
Voltage range 4	up to 3.15	79H-A1H
Voltage range 5	up to 3.85	A2H-C5H

2.1.2 Example of calculating analog key resistance

Fig. 2-1 Example of Calculating Analog Key Resistance

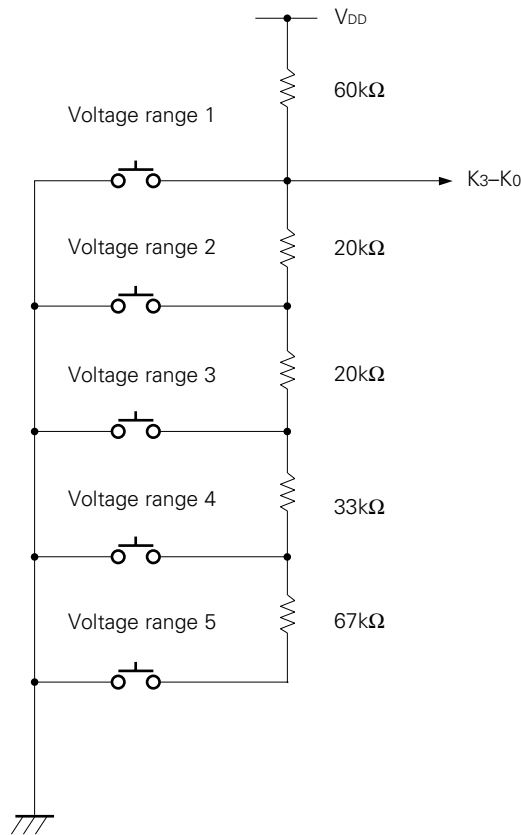

2.1.3 Analog key matrix when FUNC = 0

Voltage Range Input Pin	Voltage Range 1	Voltage Range 2	Voltage Range 3	Voltage Range 4	Voltage Range 5
K ₃	M1	M2	M3	M4	M5
K ₂	SEEK/MAN UP	SEEK/MAN DOWN	RDS	TP/SK	SHIFT
K ₁	BAND	DISP (LOUD)	ME	CD	PTY
K ₀	PSCAN/ASM	MONO	REGION	LOC	NR

2.1.4 Analog key matrix when FUNC = 1

Voltage Range Input Pin	Voltage Range 1	Voltage Range 2	Voltage Range 3	Voltage Range 4	Voltage Range 5
K ₃	M1 (PSCAN/ASM)	M2 (MONO)	M3 (REGION)	M4 (LOC)	M5 (NR)
K ₂	SEEK/MAN UP	SEEK/MAN DOWN	RDS	TP/SK	SHIFT
K ₁	BAND	DISP/LOUD	ME	CD	PTY
K ₀	—	—	—	—	—

(): SHIFT mode key

— : open

2.2 Description of Analog Key Matrix

Symbol	Functional Description						
<div style="display: flex; flex-direction: column; align-items: center; gap: 10px;"> <div style="border: 1px solid black; padding: 2px 10px; margin: 2px;">M1</div> <div style="border: 1px solid black; padding: 2px 10px; margin: 2px;">M2</div> <div style="border: 1px solid black; padding: 2px 10px; margin: 2px;">M3</div> <div style="border: 1px solid black; padding: 2px 10px; margin: 2px;">M4</div> <div style="border: 1px solid black; padding: 2px 10px; margin: 2px;">M5</div> </div>	<p>(1) Normal mode</p> <p>These keys operate as preset memory call and write keys in tuner mode.</p> <p>One key can be independently assigned to preset memories storing five stations in each of the FM1, FM2, FM3, and AM bands, totaling 20 stations.</p> <p>If a station written to preset memory is an FM-band RDS broadcasting station, the PI code of that station is also written at the same time.</p> <p>If a station is called for which RDS broadcasting is stored, AF selection is performed by using the AF list of preset 8 stations. If RDS broadcasting still cannot be received, a PI seek operation is performed in the up direction. If SEEK/MAN DOWN key is pressed during this seek operation, a normal seek operation is performed and continued until a station is found. To stop the seek operation, press the SEEK/MAN UP key.</p> <p>During a time or PS display, the frequency display is switched to.</p> <table border="1" style="width: 100%; border-collapse: collapse;"> <thead> <tr> <th data-bbox="380 674 516 716">Operation</th> <th data-bbox="516 674 1373 716">Description</th> </tr> </thead> <tbody> <tr> <td data-bbox="380 716 516 1234" style="text-align: center; vertical-align: middle;">Write</td> <td data-bbox="516 716 1373 1234"> <ul style="list-style-type: none"> ● When MESEL switch of initial setting diode = 1 (shorted with diode) Preset memory is write-enabled for about 5 seconds when ME key is pressed. By pressing any of the M1 to M5 keys during this period, the frequency currently being received is written to preset memory corresponding to the pressed key. Frequency cannot be written if the ME key is held down. When frequency is written, a beep sound is issued for about 40 ms. ● When MESEL switch of initial setting diode = 0 (open) By pressing any of M1 to M5 keys for about 2 seconds, frequency currently being received is written to preset memory corresponding to the pressed key. ME key is invalid. Same operation is performed when same preset memory key is pressed while contents of current preset memory are being received. When frequency is written, a beep sound is issued for about 40 ms. </td> </tr> <tr> <td data-bbox="380 1234 516 1608" style="text-align: center; vertical-align: middle;">Call</td> <td data-bbox="516 1234 1373 1608"> <ul style="list-style-type: none"> ● When MESEL switch of initial setting diode = 1 (shorted with diode) By pressing any of the M1 to M5 keys when preset memory is not write-enabled, contents of preset memory corresponding to the pressed key are called. ● When MESEL switch of initial setting diode = 0 (open) By pressing any of the M1 to M5 keys and then releasing the key within seconds, contents of preset memory corresponding to the pressed key are called. When same preset memory key is called while contents of preset memory are currently called, a beep sound is issued for about 40 ms. </td> </tr> </tbody> </table>	Operation	Description	Write	<ul style="list-style-type: none"> ● When MESEL switch of initial setting diode = 1 (shorted with diode) Preset memory is write-enabled for about 5 seconds when ME key is pressed. By pressing any of the M1 to M5 keys during this period, the frequency currently being received is written to preset memory corresponding to the pressed key. Frequency cannot be written if the ME key is held down. When frequency is written, a beep sound is issued for about 40 ms. ● When MESEL switch of initial setting diode = 0 (open) By pressing any of M1 to M5 keys for about 2 seconds, frequency currently being received is written to preset memory corresponding to the pressed key. ME key is invalid. Same operation is performed when same preset memory key is pressed while contents of current preset memory are being received. When frequency is written, a beep sound is issued for about 40 ms. 	Call	<ul style="list-style-type: none"> ● When MESEL switch of initial setting diode = 1 (shorted with diode) By pressing any of the M1 to M5 keys when preset memory is not write-enabled, contents of preset memory corresponding to the pressed key are called. ● When MESEL switch of initial setting diode = 0 (open) By pressing any of the M1 to M5 keys and then releasing the key within seconds, contents of preset memory corresponding to the pressed key are called. When same preset memory key is called while contents of preset memory are currently called, a beep sound is issued for about 40 ms.
Operation	Description						
Write	<ul style="list-style-type: none"> ● When MESEL switch of initial setting diode = 1 (shorted with diode) Preset memory is write-enabled for about 5 seconds when ME key is pressed. By pressing any of the M1 to M5 keys during this period, the frequency currently being received is written to preset memory corresponding to the pressed key. Frequency cannot be written if the ME key is held down. When frequency is written, a beep sound is issued for about 40 ms. ● When MESEL switch of initial setting diode = 0 (open) By pressing any of M1 to M5 keys for about 2 seconds, frequency currently being received is written to preset memory corresponding to the pressed key. ME key is invalid. Same operation is performed when same preset memory key is pressed while contents of current preset memory are being received. When frequency is written, a beep sound is issued for about 40 ms. 						
Call	<ul style="list-style-type: none"> ● When MESEL switch of initial setting diode = 1 (shorted with diode) By pressing any of the M1 to M5 keys when preset memory is not write-enabled, contents of preset memory corresponding to the pressed key are called. ● When MESEL switch of initial setting diode = 0 (open) By pressing any of the M1 to M5 keys and then releasing the key within seconds, contents of preset memory corresponding to the pressed key are called. When same preset memory key is called while contents of preset memory are currently called, a beep sound is issued for about 40 ms. 						

Symbol	Functional Description																																										
	<p>Following frequency is written to the <input type="text" value="M1"/> to <input type="text" value="M5"/> keys on power application so that the set can be easily adjusted:</p> <table border="1" style="margin: 10px auto;"> <thead> <tr> <th style="text-align: center;">Preset memory number Band</th> <th>M1</th> <th>M2</th> <th>M3</th> <th>M4</th> <th>M5</th> </tr> </thead> <tbody> <tr> <td>FM1 (MHz)</td> <td>87.50</td> <td>89.90</td> <td>97.90</td> <td>105.90</td> <td>107.90</td> </tr> <tr> <td>FM2 (MHz)</td> <td>87.50</td> <td>87.50</td> <td>87.50</td> <td>87.50</td> <td>87.50</td> </tr> <tr> <td>FM3 (MHz)</td> <td>87.50</td> <td>87.50</td> <td>87.50</td> <td>87.50</td> <td>87.50</td> </tr> <tr> <td>AM (kHz)</td> <td>144</td> <td>153</td> <td>522</td> <td>603</td> <td>1404</td> </tr> </tbody> </table> <p>(2) Shift mode</p> <p>When any of the <input type="text" value="M1"/> to <input type="text" value="M5"/> keys is pressed in shift mode, and when FUNC of initial setting diode = 1, the pressed key serves as a double function key. Function key assigned to each of the M1 to M5 keys is shown below. For operation of each key, refer to description of the key. When FUNC of initial setting diode = 0, function key is invalid.</p> <table border="1" style="margin: 10px auto;"> <thead> <tr> <th style="width: 15%;">Key</th> <th>Key assignment in shift mode</th> </tr> </thead> <tbody> <tr> <td style="text-align: center;"><input type="text" value="M1"/></td> <td> <ul style="list-style-type: none"> ● When pressed less than 2 seconds Preset scan operation ● When pressed for 2 seconds or longer Auto store memory operation Refer to <input type="text" value="PSCAN/ASM"/> key. </td> </tr> <tr> <td style="text-align: center;"><input type="text" value="M2"/></td> <td>Forced monaural ON/OFF operation Refer to <input type="text" value="MONO"/> key.</td> </tr> <tr> <td style="text-align: center;"><input type="text" value="M3"/></td> <td>ON/OFF selection of area cover code judgment procedure selection of PI code Refer to <input type="text" value="REGION"/> key.</td> </tr> <tr> <td style="text-align: center;"><input type="text" value="M4"/></td> <td>Local (LOCAL/DX) control key Refer to <input type="text" value="LOC"/> key.</td> </tr> <tr> <td style="text-align: center;"><input type="text" value="M5"/></td> <td>Tape noise reduction key Refer to <input type="text" value="NR"/> key.</td> </tr> </tbody> </table>	Preset memory number Band	M1	M2	M3	M4	M5	FM1 (MHz)	87.50	89.90	97.90	105.90	107.90	FM2 (MHz)	87.50	87.50	87.50	87.50	87.50	FM3 (MHz)	87.50	87.50	87.50	87.50	87.50	AM (kHz)	144	153	522	603	1404	Key	Key assignment in shift mode	<input type="text" value="M1"/>	<ul style="list-style-type: none"> ● When pressed less than 2 seconds Preset scan operation ● When pressed for 2 seconds or longer Auto store memory operation Refer to <input type="text" value="PSCAN/ASM"/> key.	<input type="text" value="M2"/>	Forced monaural ON/OFF operation Refer to <input type="text" value="MONO"/> key.	<input type="text" value="M3"/>	ON/OFF selection of area cover code judgment procedure selection of PI code Refer to <input type="text" value="REGION"/> key.	<input type="text" value="M4"/>	Local (LOCAL/DX) control key Refer to <input type="text" value="LOC"/> key.	<input type="text" value="M5"/>	Tape noise reduction key Refer to <input type="text" value="NR"/> key.
Preset memory number Band	M1	M2	M3	M4	M5																																						
FM1 (MHz)	87.50	89.90	97.90	105.90	107.90																																						
FM2 (MHz)	87.50	87.50	87.50	87.50	87.50																																						
FM3 (MHz)	87.50	87.50	87.50	87.50	87.50																																						
AM (kHz)	144	153	522	603	1404																																						
Key	Key assignment in shift mode																																										
<input type="text" value="M1"/>	<ul style="list-style-type: none"> ● When pressed less than 2 seconds Preset scan operation ● When pressed for 2 seconds or longer Auto store memory operation Refer to <input type="text" value="PSCAN/ASM"/> key.																																										
<input type="text" value="M2"/>	Forced monaural ON/OFF operation Refer to <input type="text" value="MONO"/> key.																																										
<input type="text" value="M3"/>	ON/OFF selection of area cover code judgment procedure selection of PI code Refer to <input type="text" value="REGION"/> key.																																										
<input type="text" value="M4"/>	Local (LOCAL/DX) control key Refer to <input type="text" value="LOC"/> key.																																										
<input type="text" value="M5"/>	Tape noise reduction key Refer to <input type="text" value="NR"/> key.																																										
<input type="text" value="M1"/>																																											
<input type="text" value="M2"/>																																											
<input type="text" value="M3"/>																																											
<input type="text" value="M4"/>																																											
<input type="text" value="M5"/>																																											

Symbol	Functional Description
	<p>These keys are used to increment/decrement receive frequency while frequency is displayed and, in combination with DISP key, to adjust timer while time is displayed.</p> <p>(1) During frequency display</p> <p>Each time SHIFT key is pressed, manual tuning function and auto tuning function are alternately selected.</p> <p>When auto tuning function is selected (not in shift mode), "AUTO" on LCD panel lights.</p> <p>When this key is pressed while auto tuning function is selected and while time or PS is displayed, frequency is displayed.</p> <p>If no station is assigned to frequency at which seek operation has been stopped, frequency (last channel) at which seek operation was started is displayed again. Even if mode is changed between tape/CD and radio modes during seek operation, seek operation continues. If mode is changed between radio mode to tape/CD mode at this time, tape/CD is displayed for about 3 seconds. If seek operation still continues after that, frequency is displayed.</p> <p>When auto tuning of FM band is performed, frequency is incremented/decremented in 100 kHz units. In manual tuning mode, it is incremented/decremented in 50 kHz units.</p> <ul style="list-style-type: none"> ● Normal mode <ul style="list-style-type: none"> ● SEEK/MAN UP Frequency is incremented (SEEK/MAN UP key) or decremented (SEEK/MAN DOWN key) 1 channel space at a time, and presence/absence of broadcasting station (SD + IF count or SD: depending on IF/SD switch of initial setting diode) is detected for each receive frequency. If presence of station is detected, frequency of station is held. ● RDS seek in FM band When presence of station is detected, RDS pin (pin 10) is checked. If RDS signal is input within about 500 ms, input of RDS data is started. When RDS data has been input, its frequency is held. If RDS data is not input within about 1.5 seconds, seek operation continues. If RDS signal is missing, seek operation continues. ● PTY seek in FM band When presence of broadcasting station is detected, whether it is an RDS station is judged. If RDS data is input, its PTY is checked. If PTY is different from that expected, seek operation continues. If PTY matches, its frequency is held. ● TP/SK seek in FM band When presence of station is detected, whether it is an RDS station is judged. When RDS data is input, TP bit is checked. If traffic information station is being received, its frequency is held. If station is not traffic information station, seek operation continues. If RDS signal is missing, SK pin is checked. If SK signal is present, its frequency is held. If not, seek operation continues.

Symbol	Functional Description												
<p style="text-align: center;">SEEK/MAN UP</p> <p style="text-align: center;">SEEK/MAN DOWN</p>	<p>During seek operation, operation of each key is as follows:</p> <table border="1" style="width: 100%; border-collapse: collapse;"> <thead> <tr> <th style="width: 20%;">Key</th> <th>Operation</th> </tr> </thead> <tbody> <tr> <td style="text-align: center;"> <div style="border: 1px solid black; padding: 2px; display: inline-block;">M1</div> <small>2</small> </td> <td>Stops seek operation.</td> </tr> <tr> <td style="text-align: center;"> <div style="border: 1px solid black; padding: 2px; display: inline-block;">M5</div> </td> <td>Calls contents of preset memory corresponding to pressed key.</td> </tr> <tr> <td style="text-align: center;"> <div style="border: 1px solid black; padding: 2px; display: inline-block;">SEEK/MAN UP</div> <div style="border: 1px solid black; padding: 2px; display: inline-block;">SEEK/MAN DOWN</div> </td> <td> <ul style="list-style-type: none"> ● In normal mode Stops seek operation. <ul style="list-style-type: none"> • <div style="border: 1px solid black; padding: 2px; display: inline-block;">SEEK/MAN UP</div> key during seek up and <div style="border: 1px solid black; padding: 2px; display: inline-block;">SEEK/MAN DOWN</div> key during seek down Stops seek operation and calls frequency before seek operation. • <div style="border: 1px solid black; padding: 2px; display: inline-block;">SEEK/MAN DOWN</div> key during seek up and <div style="border: 1px solid black; padding: 2px; display: inline-block;">SEEK/MAN UP</div> key during seek down Operation of pressed key is started from frequency at which key is pressed. ● In shift mode Starts manual up/down operation from frequency at which key is pressed. </td> </tr> <tr> <td style="text-align: center;"> <div style="border: 1px solid black; padding: 2px; display: inline-block;">TP/SK</div> <div style="border: 1px solid black; padding: 2px; display: inline-block;">LOC</div> <div style="border: 1px solid black; padding: 2px; display: inline-block;">LOUD</div> <div style="border: 1px solid black; padding: 2px; display: inline-block;">SHIFT</div> <div style="border: 1px solid black; padding: 2px; display: inline-block;">RDS</div> </td> <td> <p>Seek operation continues.</p> <p>Operation of pressed key is started.</p> </td> </tr> <tr> <td style="text-align: center;"> <div style="border: 1px solid black; padding: 2px; display: inline-block;">PSCAN/ASM</div> <div style="border: 1px solid black; padding: 2px; display: inline-block;">BAND</div> </td> <td> <p>Seek operation is stopped.</p> <p>Operation of pressed key is started.</p> </td> </tr> </tbody> </table> <p>Analog keys other than above are invalid.</p> <ul style="list-style-type: none"> ● Shift mode When manual tuning function is effected, frequency is incremented by 1 step (1 channel space) when <div style="border: 1px solid black; padding: 2px; display: inline-block;">SEEK/MAN UP</div> key is pressed, or decremented by 1 step when <div style="border: 1px solid black; padding: 2px; display: inline-block;">SEEK/MAN DOWN</div> key is pressed. If key is held down for more than 0.5 second, frequency is incremented/decremented in fast-forward mode at rate of about 40 ms/step, until key is released. If key is held down while manual tuning function is in effect, all other keys are invalid. When time of PS is displayed, frequency is displayed instead. <p>(2) During time display When <div style="border: 1px solid black; padding: 2px; display: inline-block;">SEEK/MAN UP</div> or <div style="border: 1px solid black; padding: 2px; display: inline-block;">SEEK/MAN DOWN</div> key is pressed while time is displayed and while <div style="border: 1px solid black; padding: 2px; display: inline-block;">DISP</div> key is pressed, hour digits and minute digits can be adjusted. If <div style="border: 1px solid black; padding: 2px; display: inline-block;">DISP</div> key is not held down, frequency display is switched to and operations that are normally performed while frequency is displayed are performed.</p>	Key	Operation	<div style="border: 1px solid black; padding: 2px; display: inline-block;">M1</div> <small>2</small>	Stops seek operation.	<div style="border: 1px solid black; padding: 2px; display: inline-block;">M5</div>	Calls contents of preset memory corresponding to pressed key.	<div style="border: 1px solid black; padding: 2px; display: inline-block;">SEEK/MAN UP</div> <div style="border: 1px solid black; padding: 2px; display: inline-block;">SEEK/MAN DOWN</div>	<ul style="list-style-type: none"> ● In normal mode Stops seek operation. <ul style="list-style-type: none"> • <div style="border: 1px solid black; padding: 2px; display: inline-block;">SEEK/MAN UP</div> key during seek up and <div style="border: 1px solid black; padding: 2px; display: inline-block;">SEEK/MAN DOWN</div> key during seek down Stops seek operation and calls frequency before seek operation. • <div style="border: 1px solid black; padding: 2px; display: inline-block;">SEEK/MAN DOWN</div> key during seek up and <div style="border: 1px solid black; padding: 2px; display: inline-block;">SEEK/MAN UP</div> key during seek down Operation of pressed key is started from frequency at which key is pressed. ● In shift mode Starts manual up/down operation from frequency at which key is pressed. 	<div style="border: 1px solid black; padding: 2px; display: inline-block;">TP/SK</div> <div style="border: 1px solid black; padding: 2px; display: inline-block;">LOC</div> <div style="border: 1px solid black; padding: 2px; display: inline-block;">LOUD</div> <div style="border: 1px solid black; padding: 2px; display: inline-block;">SHIFT</div> <div style="border: 1px solid black; padding: 2px; display: inline-block;">RDS</div>	<p>Seek operation continues.</p> <p>Operation of pressed key is started.</p>	<div style="border: 1px solid black; padding: 2px; display: inline-block;">PSCAN/ASM</div> <div style="border: 1px solid black; padding: 2px; display: inline-block;">BAND</div>	<p>Seek operation is stopped.</p> <p>Operation of pressed key is started.</p>
Key	Operation												
<div style="border: 1px solid black; padding: 2px; display: inline-block;">M1</div> <small>2</small>	Stops seek operation.												
<div style="border: 1px solid black; padding: 2px; display: inline-block;">M5</div>	Calls contents of preset memory corresponding to pressed key.												
<div style="border: 1px solid black; padding: 2px; display: inline-block;">SEEK/MAN UP</div> <div style="border: 1px solid black; padding: 2px; display: inline-block;">SEEK/MAN DOWN</div>	<ul style="list-style-type: none"> ● In normal mode Stops seek operation. <ul style="list-style-type: none"> • <div style="border: 1px solid black; padding: 2px; display: inline-block;">SEEK/MAN UP</div> key during seek up and <div style="border: 1px solid black; padding: 2px; display: inline-block;">SEEK/MAN DOWN</div> key during seek down Stops seek operation and calls frequency before seek operation. • <div style="border: 1px solid black; padding: 2px; display: inline-block;">SEEK/MAN DOWN</div> key during seek up and <div style="border: 1px solid black; padding: 2px; display: inline-block;">SEEK/MAN UP</div> key during seek down Operation of pressed key is started from frequency at which key is pressed. ● In shift mode Starts manual up/down operation from frequency at which key is pressed. 												
<div style="border: 1px solid black; padding: 2px; display: inline-block;">TP/SK</div> <div style="border: 1px solid black; padding: 2px; display: inline-block;">LOC</div> <div style="border: 1px solid black; padding: 2px; display: inline-block;">LOUD</div> <div style="border: 1px solid black; padding: 2px; display: inline-block;">SHIFT</div> <div style="border: 1px solid black; padding: 2px; display: inline-block;">RDS</div>	<p>Seek operation continues.</p> <p>Operation of pressed key is started.</p>												
<div style="border: 1px solid black; padding: 2px; display: inline-block;">PSCAN/ASM</div> <div style="border: 1px solid black; padding: 2px; display: inline-block;">BAND</div>	<p>Seek operation is stopped.</p> <p>Operation of pressed key is started.</p>												

Key	Functional Description										
<p style="text-align: center;">SEEK/MAN UP</p> <p style="text-align: center;">SEEK/MAN DOWN</p>	<p>• Hour digit adjustment Each time SEEK/MAN DOWN key is pressed, hour advances by 1 hour. If key is held down for more than 0.5 second, hour is incremented in fast-forward mode by 1 hour every 200 ms, until key is released. Minute digits and second count value are not affected.</p> <p>• Minute digit adjustment Each time SEEK/MAN UP key is pressed, minute advances by 1 minute. If key is held down for more than 0.5 second, minute is incremented in fast-forward mode by 1 minute every 100 ms, until key is released. No carry to hour digit occurs. Each time adjustment is made, second counter is reset. During adjustment, colon remains lighted.</p>										
<p style="text-align: center;">ME</p>	<p>When MESEL switch of initial setting diode = 1 (shorted with diode), this key is used to enable preset memory to be written. When data is written to preset memory, beep sound is issued for about 40 ms. This key is invalid when MESEL switch = 0 (open).</p> <p>● During frequency display This key is used to enable preset memory to be written. When this key is pressed, data can be written to preset memory for about 5 seconds from point at which key is pressed. By pressing any of the M1 to M5 keys, currently received frequency is written to preset memory corresponding to pressed key. If ME key is held down at this time, frequency cannot be written. In memory write-enable status, operation of each key is as follows:</p> <table border="1" data-bbox="367 1104 1357 1587"> <thead> <tr> <th data-bbox="367 1104 521 1150">Key</th> <th data-bbox="521 1104 1357 1150">Operation</th> </tr> </thead> <tbody> <tr> <td data-bbox="367 1150 521 1308"> <p style="text-align: center;">M1</p> <p style="text-align: center;">?</p> <p style="text-align: center;">M5</p> </td> <td data-bbox="521 1150 1357 1308"> Cancel memory write-enable status. When any of these keys is pressed, currently received frequency is written to preset memory corresponding to pressed key. Mute output is not performed. For details, refer to description of the M1 to M5 keys. </td> </tr> <tr> <td data-bbox="367 1308 521 1451"> <p style="text-align: center;">PSCAN/ASM</p> </td> <td data-bbox="521 1308 1357 1451"> Cancel memory write-enable status. If this key is held down for about 2 seconds, auto store memory operation is performed. If it is pressed less than 2 seconds, preset memory scan operation is performed. </td> </tr> <tr> <td data-bbox="367 1451 521 1535"> <p style="text-align: center;">SEEK/MAN UP</p> <p style="text-align: center;">SEEK/MAN DOWN</p> </td> <td data-bbox="521 1451 1357 1535"> Cancel memory write-enable status. Operation of pressed key is started from current frequency. </td> </tr> <tr> <td data-bbox="367 1535 521 1587"> <p style="text-align: center;">ME</p> </td> <td data-bbox="521 1535 1357 1587"> Cancels memory write-enable status. </td> </tr> </tbody> </table>	Key	Operation	<p style="text-align: center;">M1</p> <p style="text-align: center;">?</p> <p style="text-align: center;">M5</p>	Cancel memory write-enable status. When any of these keys is pressed, currently received frequency is written to preset memory corresponding to pressed key. Mute output is not performed. For details, refer to description of the M1 to M5 keys.	<p style="text-align: center;">PSCAN/ASM</p>	Cancel memory write-enable status. If this key is held down for about 2 seconds, auto store memory operation is performed. If it is pressed less than 2 seconds, preset memory scan operation is performed.	<p style="text-align: center;">SEEK/MAN UP</p> <p style="text-align: center;">SEEK/MAN DOWN</p>	Cancel memory write-enable status. Operation of pressed key is started from current frequency.	<p style="text-align: center;">ME</p>	Cancels memory write-enable status.
Key	Operation										
<p style="text-align: center;">M1</p> <p style="text-align: center;">?</p> <p style="text-align: center;">M5</p>	Cancel memory write-enable status. When any of these keys is pressed, currently received frequency is written to preset memory corresponding to pressed key. Mute output is not performed. For details, refer to description of the M1 to M5 keys.										
<p style="text-align: center;">PSCAN/ASM</p>	Cancel memory write-enable status. If this key is held down for about 2 seconds, auto store memory operation is performed. If it is pressed less than 2 seconds, preset memory scan operation is performed.										
<p style="text-align: center;">SEEK/MAN UP</p> <p style="text-align: center;">SEEK/MAN DOWN</p>	Cancel memory write-enable status. Operation of pressed key is started from current frequency.										
<p style="text-align: center;">ME</p>	Cancels memory write-enable status.										

Key	Operation								
<p style="text-align: center;">ME</p>	<table border="1" style="width: 100%; border-collapse: collapse;"> <thead> <tr> <th style="width: 20%;">Key</th> <th>Operation</th> </tr> </thead> <tbody> <tr> <td style="text-align: center;">TP/SK</td> <td> <ul style="list-style-type: none"> • FM band Cancels memory write-enable status. Performs operation of TP/SK key. • Other band Invalid key. </td> </tr> <tr> <td style="text-align: center;"> LOC DISP SHIFT BAND LOUD </td> <td> Cancel memory write-enable status. Operation of pressed key is performed. </td> </tr> <tr> <td style="text-align: center;">RDS</td> <td> <ul style="list-style-type: none"> • FM band Cancels memory write-enable status. Performs operation of pressed key. • Other band Invalid key. </td> </tr> </tbody> </table> <p>Analog keys other than above are invalid.</p>	Key	Operation	TP/SK	<ul style="list-style-type: none"> • FM band Cancels memory write-enable status. Performs operation of TP/SK key. • Other band Invalid key. 	LOC DISP SHIFT BAND LOUD	Cancel memory write-enable status. Operation of pressed key is performed.	RDS	<ul style="list-style-type: none"> • FM band Cancels memory write-enable status. Performs operation of pressed key. • Other band Invalid key.
Key	Operation								
TP/SK	<ul style="list-style-type: none"> • FM band Cancels memory write-enable status. Performs operation of TP/SK key. • Other band Invalid key. 								
LOC DISP SHIFT BAND LOUD	Cancel memory write-enable status. Operation of pressed key is performed.								
RDS	<ul style="list-style-type: none"> • FM band Cancels memory write-enable status. Performs operation of pressed key. • Other band Invalid key. 								
<p style="text-align: center;">PSCAN/ASM</p>	<p>When this key is held down for 2 seconds or longer, auto store operation is performed; when it is pressed less than 2 seconds, preset memory scan operation is performed. If time or PS is displayed, frequency is displayed instead.</p> <ul style="list-style-type: none"> ● Preset memory scan Preset memories are sequentially called 5 seconds each starting from preset memory M1 if station outside of current preset memory is being received, or from next preset memory if preset memory is being received (e.g., from M4 if M3 is received), as illustrated below. <div style="text-align: center; margin: 10px 0;"> <pre> ──▶ M1 → M2 → M3 → M4 → M5 ── </pre> </div> <p>When next preset memory is called after hold period of 5 seconds, beep sound is issued for about 40 ms.</p>								

Symbol	Functional Description												
<p style="text-align: center;">PSCAN/ASM</p>	<p>Operation of each key is as follows while preset memories are being scanned:</p> <table border="1" style="width: 100%; border-collapse: collapse;"> <thead> <tr> <th style="width: 20%;">Key</th> <th>Operation</th> </tr> </thead> <tbody> <tr> <td style="text-align: center;">PSCAN/ASM</td> <td> <ul style="list-style-type: none"> ● If released within 2 seconds Preset memory scanning is stopped, and frequency at which key was pressed is held. ● If held down for 2 seconds or more Preset memory scanning is stopped, and auto store memory operation is started. </td> </tr> <tr> <td style="text-align: center;">M1 ? M5</td> <td> Stop preset memory scanning. Call contents of preset memory corresponding to pressed key. However, nothing can be written to preset memory. </td> </tr> <tr> <td style="text-align: center;">SEEK/MAN UP SEEK/MAN DOWN</td> <td> Stop preset memory scanning. Operation of pressed key is started from frequency at which key was pressed. </td> </tr> <tr> <td style="text-align: center;">BAND</td> <td>Stops preset memory scanning and selects band.</td> </tr> <tr> <td style="text-align: center;">TP/SK LOC LOUD SHIFT RDS</td> <td> Continue preset memory scanning. Operation of pressed key is performed. </td> </tr> </tbody> </table> <p style="margin-top: 10px;">Analog keys other than above are invalid.</p> <ul style="list-style-type: none"> ● Auto store memory Searches broadcasting stations in DX mode in range from lower limit (minimum frequency) to upper limit (maximum frequency) of currently received band, writes preset number of stations starting from one with highest signal meter level, and then sorts stations in order of frequency. In this case, if RDS broadcasting is received in FM band, the PI code of that station is also recorded at the same time. If stations having same PI codes are found, only station with highest signal meter level is written. After operation, M1 is received. If no station is found, frequency at which operation was started is resumed. (a) If stations have been written to all the keys M1 through M5 and then another station is found If signal meter level of that station is lower than signal meter level of station written to M5, selection operation continues. If signal meter level is higher, that station is written to M5, stations written to M1 to M5 are sorted again starting from highest signal meter level, and then selection operation continues. If stations with same signal meter level are found, it is assumed that signal meter level of station found first is higher. (b) If number of stations falls short of number of preset stations Stations found so far are sequentially written to preset memory starting from M1, and found stations are sorted in order of frequency. Contents of remaining preset memory before auto store memory operation was performed are preserved. 	Key	Operation	PSCAN/ASM	<ul style="list-style-type: none"> ● If released within 2 seconds Preset memory scanning is stopped, and frequency at which key was pressed is held. ● If held down for 2 seconds or more Preset memory scanning is stopped, and auto store memory operation is started. 	M1 ? M5	Stop preset memory scanning. Call contents of preset memory corresponding to pressed key. However, nothing can be written to preset memory.	SEEK/MAN UP SEEK/MAN DOWN	Stop preset memory scanning. Operation of pressed key is started from frequency at which key was pressed.	BAND	Stops preset memory scanning and selects band.	TP/SK LOC LOUD SHIFT RDS	Continue preset memory scanning. Operation of pressed key is performed.
Key	Operation												
PSCAN/ASM	<ul style="list-style-type: none"> ● If released within 2 seconds Preset memory scanning is stopped, and frequency at which key was pressed is held. ● If held down for 2 seconds or more Preset memory scanning is stopped, and auto store memory operation is started. 												
M1 ? M5	Stop preset memory scanning. Call contents of preset memory corresponding to pressed key. However, nothing can be written to preset memory.												
SEEK/MAN UP SEEK/MAN DOWN	Stop preset memory scanning. Operation of pressed key is started from frequency at which key was pressed.												
BAND	Stops preset memory scanning and selects band.												
TP/SK LOC LOUD SHIFT RDS	Continue preset memory scanning. Operation of pressed key is performed.												

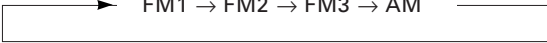
Symbol	Functional Description												
<p>PSCAN/ASM</p>	<p>Press this key again to stop auto store memory operation. Stations so far found are written to preset memories and sorted in order of frequency. If number of stations found is less than 5, remaining preset memory preserves previous contents.</p> <p>If operation mode is changed during auto store memory operation, stations found so far are written to preset memories and sorted in order of frequency. If number of stations found is less than 5, remaining preset memory preserves previous contents.</p> <p>During auto store memory operation, keys other than PSCAN/ASM, CD, and SHIFT are invalid.</p>												
<p>SHIFT</p>	<p>This key selects function of double function key and tuning function when FUNC of initial setting diode = 1.</p> <p>Each time this key is pressed while frequency is displayed, manual tuning and auto tuning functions are alternately selected. At this time, output of SHIFT pin (pin 56) is also alternately changed between low and high levels. SHIFT pin outputs high level as default value.</p>												
<p>BAND</p>	<p>This key selects received band in tuner mode. Default band is FM1. Each time this key is pressed, band is changed as follows:</p> <div style="text-align: center;">  </div> <p>Outputs of BAND₀ and BAND₁ pins are changed as follows, depending on received band:</p> <table border="1" data-bbox="667 963 1188 1184"> <thead> <tr> <th>Pin \ Received band</th> <th>BAND₀</th> <th>BAND₁</th> </tr> </thead> <tbody> <tr> <td>FM</td> <td>1</td> <td>×</td> </tr> <tr> <td>MW</td> <td>0</td> <td>0</td> </tr> <tr> <td>LW</td> <td>0</td> <td>1</td> </tr> </tbody> </table> <p>(0 : low level, 1 : high level, × : Don't care)</p> <p>When band is changed, frequency is displayed.</p>	Pin \ Received band	BAND ₀	BAND ₁	FM	1	×	MW	0	0	LW	0	1
Pin \ Received band	BAND ₀	BAND ₁											
FM	1	×											
MW	0	0											
LW	0	1											
<p>RDS</p>	<p>Turns ON/OFF RDS mode. When RDS mode is ON, "RDS" on LCD panel lights. When RDS mode is ON, following processing is performed:</p> <ul style="list-style-type: none"> ● AF selection during on air ● PI search <p>This operation is performed when AF selection operation takes place when CE reset, band selection, or preset memory read is carried out and when AF selection operation fails.</p> <ul style="list-style-type: none"> ● Only RDS stations are detected during auto seek. <p>PS display and RDS data input are performed regardless of whether RDS mode is ON/OFF.</p>												

Symbol	Functional Description
<div data-bbox="175 814 295 842" style="border: 1px solid black; padding: 2px; display: inline-block;">DISP (LOUD)</div>	<p>(1) When pressed for less than 0.5 second Changes display or adjusts timer.</p> <p>● Display selection function Each time this key is pressed, display is changed as follows:</p> <p>(a) When PRIDISP = 0 (open)</p> <ul style="list-style-type: none"> • Tape/CD mode <div data-bbox="573 527 1182 646" style="border: 1px solid black; padding: 10px; margin: 10px 0;"> <p style="text-align: center;">→ TAPE/CD → (PS) → Frequency → Time</p> <p style="text-align: center;">↑ After 5 seconds</p> </div> <ul style="list-style-type: none"> • Tuner mode <div data-bbox="573 772 1182 892" style="border: 1px solid black; padding: 10px; margin: 10px 0;"> <p style="text-align: center;">→ (PS) → Frequency → Time</p> <p style="text-align: center;">↑ After 5 seconds</p> </div> <p>Each time key is pressed, display is changed as indicated by solid arrow. However, PS code is displayed when PS code is input.</p> <p>When PS code is input, and DISP key is not input within 5 seconds after frequency display, PS display is selected as indicated by dotted line.</p> <p>Caution Frequency display after tuning is changed to PS display as soon as PS code has been input.</p> <p>(b) When PRIDISP = 1 (shorted with diode) and PS is present</p> <ul style="list-style-type: none"> • Tape/CD mode <div data-bbox="573 1287 1182 1472" style="border: 1px solid black; padding: 10px; margin: 10px 0;"> <p style="text-align: center;">After 5 seconds</p> <p style="text-align: center;">↓</p> <p style="text-align: center;">→ TAPE/CD → PS → Frequency → Time</p> <p style="text-align: center;">↑ ↑</p> <p style="text-align: center;">After 5 seconds After 5 seconds</p> </div>

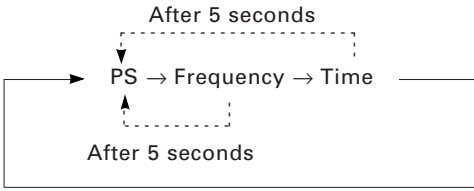
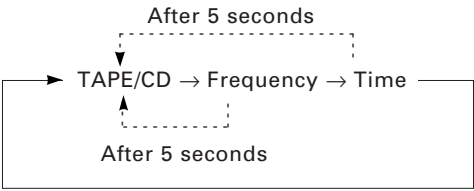
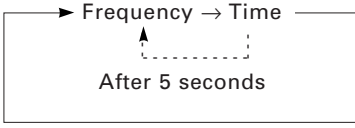
Symbol	Functional Description
	<p>• Tuner mode</p>  <p>(c) When PRIDISP = 1 (shorted with diode) and PS is absent</p> <p>• Tape/CD mode</p>  <p>DISP (LOUD)</p> <p>• Tuner mode</p>  <p>Each time this key is pressed for less than 5 seconds, display is changed as indicated by solid arrow.</p> <p>If DISP key is not input for 5 seconds or more, display is changed as indicated by dotted line.</p> <p>(2) When pressed for 0.5 second or more</p> <p>Loudness is turned ON/OFF.</p> <p>Each time this key is pressed for 0.5 second or more, output of LOUD pin (pin 72) is inverted (default status is low level).</p> <p>When loudness is ON, "LOUD" on LCD panel lights.</p>
<p>LOC</p>	<p>This is local (LOCAL/DX) control key.</p> <p>Each time this key is pressed, setting of LOCAL/DX is toggled.</p> <p>If local setting is made during seek operation, LOCAL pin (pin 69) outputs high level.</p> <p>On power application, DX setting is assumed (LOCAL pin outputs low level).</p> <p>When local setting is made, "LOC" on LCD panel lights.</p>

Symbol	Functional Description
<p style="text-align: center; border: 1px solid black; width: fit-content; margin: 0 auto;">MONO</p>	<p>Turns ON/OFF forced monaural.</p> <p>Forced monaural is turned OFF as default condition. MONO pin outputs high level, and "MONO" on LCD panel goes off.</p> <p>When this key is pressed, MONO pin outputs low level, and "MONO" on LCD display lights. At this time, "STEREO" is forcibly extinguished.</p> <p>This key is valid only in FM mode. In AM mode, MONO pin is fixed to low level.</p> <p>Operation continues even if band, frequency, or mode is changed.</p> <p>When this key is pressed, original setting is resumed.</p>
<p style="text-align: center; border: 1px solid black; width: fit-content; margin: 0 auto;">TP/SK</p>	<p>Turns ON/OFF TP/SK mode.</p> <p>As traffic information identification signal, TP and TA bits of RDS, and SK and DK signals are used. When TP/SK mode is ON, "TP/SK" on LCD panel lights.</p> <p>This key is invalid in a band other than FM.</p> <div style="border: 1px solid black; padding: 5px; margin: 10px auto; width: fit-content;"> <p style="text-align: center; border-bottom: 1px solid black;">Operation</p> <p style="text-align: center;">Normal or RDS mode</p> <p style="text-align: center;">↑ ↓</p> <p style="text-align: center;">TP/SK mode</p> <p style="text-align: center;">or</p> <p style="text-align: center;">RDS + TP/SK mode</p> </div> <p>If station is found during auto tuning in TP/SK mode, TP bit of RDS is checked. If TP bit cannot be detected, SK signal is checked.</p> <p>In TP/SK mode, following operation is performed if traffic information station identification signal is missing:</p> <p>(1) During normal reception</p> <p>Traffic information identification signal is checked. If it is missing for 30 consecutive seconds, SK mute signal is output. If traffic information identification signal is still missing for 3 more seconds, traffic information alarm is output.</p> <p>SK mute and traffic information alarm are continuously output until traffic information identification signal is detected.</p> <p>If traffic information identification signal is detected in this process, output of SK mute and traffic information alarm is stopped.</p> <p>(2) During tuning operation</p> <p>Output of SK mute and traffic information alarm is stopped.</p> <p>If traffic information identification signal is missing after trailing mute is turned off, SK mute is continuously output. If traffic information identification signal is still missing for 3 more seconds, traffic information alarm is output.</p> <p>During AF operation, however, previous status before starting AF operation is held.</p> <p>(3) When TP/SK mode is turned ON</p> <p>If traffic information identification signal is missing when trailing mute is turned off, output of SK mute continues. If traffic information identification signal is still missing for 3 more seconds, traffic information alarm is output.</p>

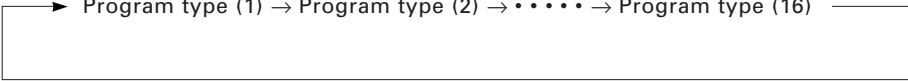
Symbol	Functional Description						
<p style="text-align: center;">TP/SK</p>	<p>(4) When CE goes high If traffic information identification signal is missing when trailing mute is turned off, output of SK mute continues. If traffic information identification signal is still missing for 3 more seconds, traffic information alarm is output.</p> <p>(5) If TP/SK mode is turned off during output of SK mute or traffic information alarm Output of SK mute or traffic information alarm is stopped.</p>						
<p style="text-align: center;">PTY</p>	<p>This key sets PTY search mode or selects PTY. It is valid in a mode other than TP/SK mode and when an FM-band RDS station is received. When this key is pressed once, PTY mode is set. At this time, "PTY" on LCD lights, and the program type of the RDS being received at that time (e.g., "NEWS", etc.) is displayed for 5 seconds. By pressing this key while program type is displayed (within 5 seconds), program type (1 to 16) can be selected, as follows:</p> <div style="text-align: center; margin: 10px 0;">  <p>Program type (1) → Program type (2) → → Program type (16)</p> </div> <p>("→": Indicates input of PTY key)</p> <p>By pressing SEEK UP or SEEK DOWN key while selected program type is displayed (within 5 seconds), an RDS station broadcasting the selected program type is searched for (during the search, "PTY" remains lit to indicate search for program type). If PTY, SEEK UP, or SEEK DOWN key is input for 5 seconds or more while program type is selected, PTY mode is canceled. If key other than PTY, SEEK UP, and SEEK DOWN is pressed while program type is selected, PTY mode is canceled, and operation of pressed key is performed.</p>						
<p style="text-align: center;">REGION</p>	<p>Turns ON/OFF judgment (region) of area cover code of PI code. This key is valid when initial setting diode REGEN = 1 (shorted with diode). While AF selection operation is performed and while region is judged to be ON by PI code during PI search, judgment is made by coincidence of 12 bits excluding area cover code. When region is off, judgment is made by coincidence of all 16 bits of PI code including area cover code. When region is ON, "REGION" on LCD panel lights. If this key is not used (when initial setting diode REGEN = 0 (open)), all 16 bits of PI code must coincide.</p>						
<p style="text-align: center;">CD</p>	<p>CD mode selection key. Each time this key is pressed CD mode and tuner/tape mode (mode before CD key is input) are alternately changed. In CD mode, MODE₀ and MODE₁ pins output as follows, and CDOUT pin outputs high level:</p> <table border="1" style="margin: 10px auto; border-collapse: collapse;"> <thead> <tr> <th style="padding: 2px;">MODE₀</th> <th style="padding: 2px;">MODE₁</th> <th style="padding: 2px;">Mode</th> </tr> </thead> <tbody> <tr> <td style="text-align: center; padding: 2px;">1</td> <td style="text-align: center; padding: 2px;">1</td> <td style="text-align: center; padding: 2px;">CD</td> </tr> </tbody> </table>	MODE ₀	MODE ₁	Mode	1	1	CD
MODE ₀	MODE ₁	Mode					
1	1	CD					

2.3 Layout of Initial Setting Diode Matrix

Output Pin (Pin No.) \ Input Pin (Pin No.)	D ₃ (37)	D ₂ (38)	D ₁ (39)	D ₀ (40)
DS ₄ (41)	FM IF/SD	AM IF/SD	AMIF1	AMIF2
DS ₃ (42)	NOCLK	CTSTRT	CTADJ	FLASH
DS ₂ (43)	RETUNE	AFSEL	BEEP	MESEL
DS ₁ (44)	DEV.SEL	FUNC	PRIDISP	CLK24
DS ₀ (45)	REGEN			

2.4 Connection of Initial Setting Diode Matrix

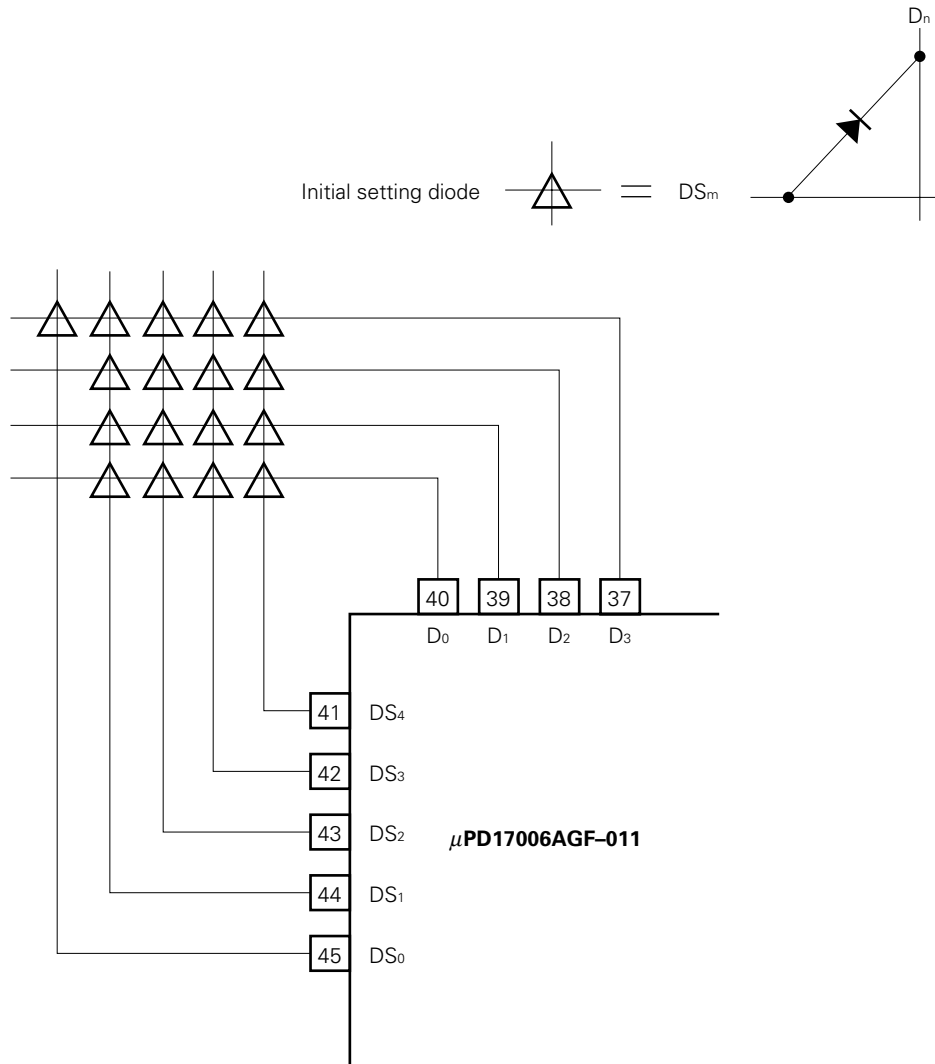

2.5 Description of Initial Setting Diode Matrix

The initial setting diode matrix has the following 17 types of settings. All these settings are read when power is supplied to the V_{DD} pin for the first time (i.e., power-ON reset) and when the CE pin goes high (CE reset), and ignored at other times.

- (1) **Switch setting method of detecting broadcasting station during auto tuning**
FM IF/SD, AM IF/SD
- (2) **Switch setting intermediate frequency of MW, LW, and SW bands**
AMIF1, AMIF2
- (3) **Switch setting timer function**
NOCLK, CTSTRT, CTADJ, FLASH
- (4) **Switch selecting ON/OFF of auto retune**
RETUNE
- (5) **Switch selecting AF selection operation**
AFSEL
- (6) **Switch selecting issuance of beep sound**
BEEP
- (7) **Switch selecting preset memory writing method and time adjustment method**
MESEL
- (8) **Switch selecting whether DEV.LEVEL is used as condition of AF selection**
DEV.SEL
- (9) **Switch selecting whether priority display is performed**
PRIDISP
- (10) **Switch selecting 12-/24-hour display of timer**
CLK24
- (11) **Switch selecting use of double function key**
FUNC
- (12) **Switch selecting use of key**
REGEN

These switches are short-circuited or opened on the matrix. The tables on the following pages describe the functions of the initial setting diode matrix.

Symbol	Function																		
AM IF/SD FM IF/SD	These switches set method of detecting broadcasting station during auto tuning, and are set as follows: <table border="1" data-bbox="534 300 1284 426" style="margin-left: auto; margin-right: auto;"> <thead> <tr> <th>AM IF/SD, FM IF/SD</th> <th>Method of detecting broadcasting station</th> </tr> </thead> <tbody> <tr> <td style="text-align: center;">0</td> <td style="text-align: center;">Only SD is used</td> </tr> <tr> <td style="text-align: center;">1</td> <td style="text-align: center;">SD and IF counter are used.</td> </tr> </tbody> </table> (0 : open, 1 : shorted with diode)	AM IF/SD, FM IF/SD	Method of detecting broadcasting station	0	Only SD is used	1	SD and IF counter are used.												
AM IF/SD, FM IF/SD	Method of detecting broadcasting station																		
0	Only SD is used																		
1	SD and IF counter are used.																		
AMIF1 AMIF2	These switches set intermediate frequency of MW and LW bands. Set these switches as follows: <table border="1" data-bbox="534 533 1235 695" style="margin-left: auto; margin-right: auto;"> <thead> <tr> <th>AMIF1</th> <th>AMIF2</th> <th>Intermediate frequency</th> <th>IF count range</th> </tr> </thead> <tbody> <tr> <td style="text-align: center;">0</td> <td style="text-align: center;">0</td> <td style="text-align: center;">450 kHz</td> <td style="text-align: center;">450 ± 3 kHz</td> </tr> <tr> <td style="text-align: center;">0</td> <td style="text-align: center;">1</td> <td style="text-align: center;">459 kHz</td> <td style="text-align: center;">459 ± 3 kHz</td> </tr> <tr> <td style="text-align: center;">1</td> <td style="text-align: center;">×</td> <td style="text-align: center;">10.71 MHz</td> <td style="text-align: center;">450 ± 3 kHz</td> </tr> </tbody> </table> (0 : open, 1 : shorted with diode, × : Don't care)	AMIF1	AMIF2	Intermediate frequency	IF count range	0	0	450 kHz	450 ± 3 kHz	0	1	459 kHz	459 ± 3 kHz	1	×	10.71 MHz	450 ± 3 kHz		
AMIF1	AMIF2	Intermediate frequency	IF count range																
0	0	450 kHz	450 ± 3 kHz																
0	1	459 kHz	459 ± 3 kHz																
1	×	10.71 MHz	450 ± 3 kHz																
NOCLK CTSTRT CTADJ FLASH	These switches set timer function, as follows: <table border="1" data-bbox="430 808 1446 1045" style="margin-left: auto; margin-right: auto;"> <thead> <tr> <th>NOCLK</th> <th>Description</th> </tr> </thead> <tbody> <tr> <td style="text-align: center;">0</td> <td>Timer is used.</td> </tr> <tr> <td style="text-align: center;">1</td> <td>Timer is not used. At this time, setting of CTSTRT, CTADJ, and FLASH switches are ignored. Backup with low current dissipation can be performed when CE pin is made low.</td> </tr> </tbody> </table> <p style="text-align: center;">CTSTRT, CTADJ, and FLASH are valid when timer function is used (NOCLK switch = 1).</p> <table border="1" data-bbox="430 1138 1446 1375" style="margin-left: auto; margin-right: auto;"> <thead> <tr> <th>CTSTRT</th> <th>Description</th> </tr> </thead> <tbody> <tr> <td style="text-align: center;">0</td> <td>Timer usually operates.</td> </tr> <tr> <td style="text-align: center;">1</td> <td>Timer operation and display are not performed until RDS broadcasting is received first time when CE pin goes high. When RDS broadcasting is received, timer operation starts based on time information (CT) of RDS data at that time. Backup with low power dissipation can be performed when CE pin is made low.</td> </tr> </tbody> </table> <table border="1" data-bbox="430 1409 1446 1617" style="margin-left: auto; margin-right: auto;"> <thead> <tr> <th>CTADJ</th> <th>Description</th> </tr> </thead> <tbody> <tr> <td style="text-align: center;">0</td> <td>Timer is not adjusted with data of RDS broadcasting. Timer operates based on internal clock.</td> </tr> <tr> <td style="text-align: center;">1</td> <td>When RDS broadcasting is received during timer operation, timer is adjusted based on time information of broadcasting.</td> </tr> </tbody> </table>	NOCLK	Description	0	Timer is used.	1	Timer is not used. At this time, setting of CTSTRT, CTADJ, and FLASH switches are ignored. Backup with low current dissipation can be performed when CE pin is made low.	CTSTRT	Description	0	Timer usually operates.	1	Timer operation and display are not performed until RDS broadcasting is received first time when CE pin goes high. When RDS broadcasting is received, timer operation starts based on time information (CT) of RDS data at that time. Backup with low power dissipation can be performed when CE pin is made low.	CTADJ	Description	0	Timer is not adjusted with data of RDS broadcasting. Timer operates based on internal clock.	1	When RDS broadcasting is received during timer operation, timer is adjusted based on time information of broadcasting.
NOCLK	Description																		
0	Timer is used.																		
1	Timer is not used. At this time, setting of CTSTRT, CTADJ, and FLASH switches are ignored. Backup with low current dissipation can be performed when CE pin is made low.																		
CTSTRT	Description																		
0	Timer usually operates.																		
1	Timer operation and display are not performed until RDS broadcasting is received first time when CE pin goes high. When RDS broadcasting is received, timer operation starts based on time information (CT) of RDS data at that time. Backup with low power dissipation can be performed when CE pin is made low.																		
CTADJ	Description																		
0	Timer is not adjusted with data of RDS broadcasting. Timer operates based on internal clock.																		
1	When RDS broadcasting is received during timer operation, timer is adjusted based on time information of broadcasting.																		

Symbol	Function						
NOCLK CTSTRT CTADJ FLASH	<table border="1"> <thead> <tr> <th>FLASH</th> <th>Colon (:) display</th> </tr> </thead> <tbody> <tr> <td>1</td> <td>Always lights</td> </tr> <tr> <td>0</td> <td>Blinks Frequency: 1 Hz Duty : 60%</td> </tr> </tbody> </table> <p>(0 : open, 1 : shorted with diode)</p>	FLASH	Colon (:) display	1	Always lights	0	Blinks Frequency: 1 Hz Duty : 60%
FLASH	Colon (:) display						
1	Always lights						
0	Blinks Frequency: 1 Hz Duty : 60%						
RETUNE	<p>This switch turns ON/OFF auto retune. Set this switch as follows:</p> <table border="1"> <thead> <tr> <th>RETUNE</th> <th>Auto retune ON/OFF</th> </tr> </thead> <tbody> <tr> <td>0</td> <td>OFF</td> </tr> <tr> <td>1</td> <td>ON</td> </tr> </tbody> </table> <p>(0 : open, 1 : shorted with diode)</p>	RETUNE	Auto retune ON/OFF	0	OFF	1	ON
RETUNE	Auto retune ON/OFF						
0	OFF						
1	ON						
AFSEL	<p>This switch selects AF selection operation during on air. Set this switch as follows:</p> <table border="1"> <thead> <tr> <th>AFSEL</th> <th>AF selection operation</th> </tr> </thead> <tbody> <tr> <td>0</td> <td>Following two types of AF selection operations are supported (for details, refer to 4.1.4 (2) AF operation description). (1) Changes AF of each station every 5 seconds (2) Changes AF of all stations at one time</td> </tr> <tr> <td>1</td> <td>Following two types of AF selection operations are supported (for details, refer to 4.1.4 (2) AF operation description). (1) Changes AF of each station at time interval of 1 to 30 seconds generated at random (2) Changes AF of each station every 5 seconds</td> </tr> </tbody> </table> <p>(0 : open, 1 : shorted with diode)</p>	AFSEL	AF selection operation	0	Following two types of AF selection operations are supported (for details, refer to 4.1.4 (2) AF operation description). (1) Changes AF of each station every 5 seconds (2) Changes AF of all stations at one time	1	Following two types of AF selection operations are supported (for details, refer to 4.1.4 (2) AF operation description). (1) Changes AF of each station at time interval of 1 to 30 seconds generated at random (2) Changes AF of each station every 5 seconds
AFSEL	AF selection operation						
0	Following two types of AF selection operations are supported (for details, refer to 4.1.4 (2) AF operation description). (1) Changes AF of each station every 5 seconds (2) Changes AF of all stations at one time						
1	Following two types of AF selection operations are supported (for details, refer to 4.1.4 (2) AF operation description). (1) Changes AF of each station at time interval of 1 to 30 seconds generated at random (2) Changes AF of each station every 5 seconds						
BEEP	<p>This switch specifies whether beep sound is issued each time key is input. Set this switch as follows:</p> <table border="1"> <thead> <tr> <th>BEEP</th> <th>Description</th> </tr> </thead> <tbody> <tr> <td>0</td> <td>Beep sound is not issued</td> </tr> <tr> <td>1</td> <td>Beep sound is issued</td> </tr> </tbody> </table> <p>(0 : open, 1 : shorted with diode)</p>	BEEP	Description	0	Beep sound is not issued	1	Beep sound is issued
BEEP	Description						
0	Beep sound is not issued						
1	Beep sound is issued						

Symbol	Function						
MESEL	<p>This switch selects method of writing preset memory, and is set as follows:</p> <table border="1"> <thead> <tr> <th>MESEL</th> <th>Preset memory writing method</th> </tr> </thead> <tbody> <tr> <td>0</td> <td>Hold down any of the <input type="text" value="M1"/> to <input type="text" value="M5"/> keys for 2 seconds or more. <input type="text" value="ME"/> key is invalid.</td> </tr> <tr> <td>1</td> <td>Press any of the <input type="text" value="M1"/> to <input type="text" value="M5"/> keys within 5 seconds after pressing <input type="text" value="ME"/> key.</td> </tr> </tbody> </table> <p>(0 : open, 1 : shorted with diode)</p>	MESEL	Preset memory writing method	0	Hold down any of the <input type="text" value="M1"/> to <input type="text" value="M5"/> keys for 2 seconds or more. <input type="text" value="ME"/> key is invalid.	1	Press any of the <input type="text" value="M1"/> to <input type="text" value="M5"/> keys within 5 seconds after pressing <input type="text" value="ME"/> key.
MESEL	Preset memory writing method						
0	Hold down any of the <input type="text" value="M1"/> to <input type="text" value="M5"/> keys for 2 seconds or more. <input type="text" value="ME"/> key is invalid.						
1	Press any of the <input type="text" value="M1"/> to <input type="text" value="M5"/> keys within 5 seconds after pressing <input type="text" value="ME"/> key.						
DEV.SEL	<p>This switch specifies whether DEV.LEVEL pin (pin 74) is used as start condition for starting AF check when RDS is ON.</p> <table border="1"> <thead> <tr> <th>DEV.SEL</th> <th>Description</th> </tr> </thead> <tbody> <tr> <td>0</td> <td>Ignored</td> </tr> <tr> <td>1</td> <td>Used</td> </tr> </tbody> </table> <p>(0 : open, 1 : shorted with diode)</p>	DEV.SEL	Description	0	Ignored	1	Used
DEV.SEL	Description						
0	Ignored						
1	Used						
PRIDISP	<p>This switch specifies whether priority display is performed. Priority display depends on what sound is currently heard. That is, tape/CD display takes precedence in tape/CD mode and standby mode, and frequency display (PS display when PS data is input) takes precedence in radio mode, radio monitor mode, and standby radio mode. If display is mode other than mode that takes precedence for display, mode that takes precedence is displayed within 5 seconds.</p> <table border="1"> <thead> <tr> <th>PRIDISP</th> <th>Description</th> </tr> </thead> <tbody> <tr> <td>0</td> <td>Without priority display</td> </tr> <tr> <td>1</td> <td>Priority display</td> </tr> </tbody> </table> <p>(0: open, 1: shorted with diode)</p>	PRIDISP	Description	0	Without priority display	1	Priority display
PRIDISP	Description						
0	Without priority display						
1	Priority display						
CLK24	<p>This switch selects 12- or 24-hour display of timer. Set this switch as follows:</p> <table border="1"> <thead> <tr> <th>CLK24</th> <th>Description</th> </tr> </thead> <tbody> <tr> <td>0</td> <td>12-hour display (with "PM" and "PM" displayed)</td> </tr> <tr> <td>1</td> <td>24-hour display</td> </tr> </tbody> </table> <p>(0 : open, 1 : shorted with diode)</p>	CLK24	Description	0	12-hour display (with "PM" and "PM" displayed)	1	24-hour display
CLK24	Description						
0	12-hour display (with "PM" and "PM" displayed)						
1	24-hour display						
FUNC	<p>This switch selects double function key function. Set this switch as follows:</p> <table border="1"> <thead> <tr> <th>FUNC</th> <th>Description</th> </tr> </thead> <tbody> <tr> <td>0</td> <td>Double function key function is not used.</td> </tr> <tr> <td>1</td> <td>Double function key function is used.</td> </tr> </tbody> </table> <p>(0 : open, 1 : shorted with diode)</p>	FUNC	Description	0	Double function key function is not used.	1	Double function key function is used.
FUNC	Description						
0	Double function key function is not used.						
1	Double function key function is used.						

Symbol	Function						
REGEN	This switch selects use of region key function. Set this switch as follows:						
	<table border="1"> <thead> <tr> <th data-bbox="354 302 518 344">REGEN</th> <th data-bbox="518 302 1365 344">Description</th> </tr> </thead> <tbody> <tr> <td data-bbox="354 344 518 386">0</td> <td data-bbox="518 344 1365 386">Region key function is not used.</td> </tr> <tr> <td data-bbox="354 386 518 428">1</td> <td data-bbox="518 386 1365 428">Region key function is used.</td> </tr> </tbody> </table>	REGEN	Description	0	Region key function is not used.	1	Region key function is used.
	REGEN	Description					
	0	Region key function is not used.					
1	Region key function is used.						
(0 : open, 1 : shorted with diode)							

3. DATA OUTPUT TO LCD CONTROLLER/DRIVER (μPD16430A)

The μPD17006AGF-011 uses the μPD16430A for LCD panel display.

Initial setting data is transferred to the μPD16430A 400 to 500 ms after the CE pin (pin 31) of the μPD17006AGF-011 has gone high.

The following figure shows the pin connections between the μPD17006AGF-011 and μPD16430A.

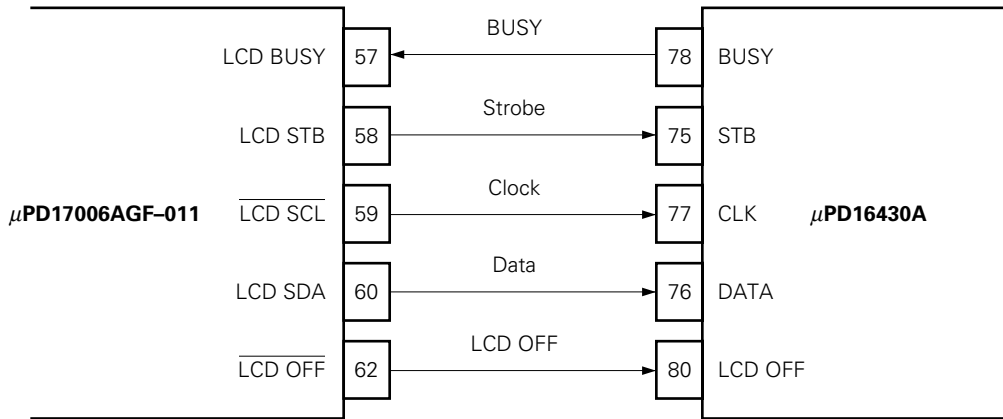

Output timing chart of serial data is shown below.

(1) Initial setting data output

Initial setting data is output to the μPD16430A as follows:

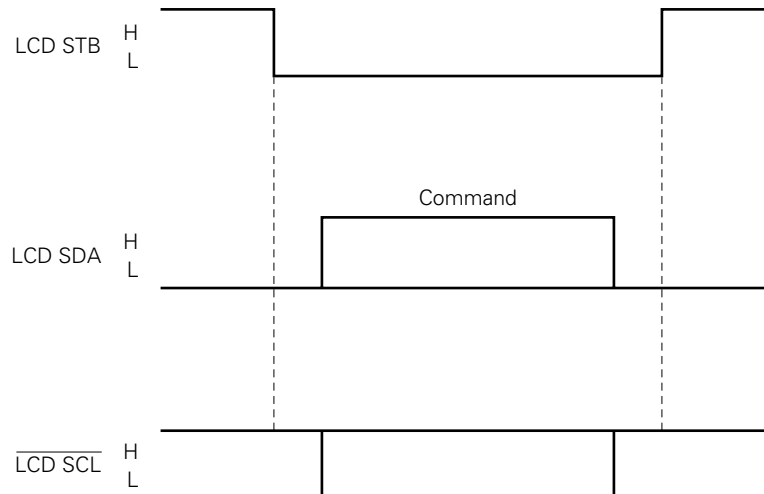

Remark Command: 00000011 (display mode setting command)

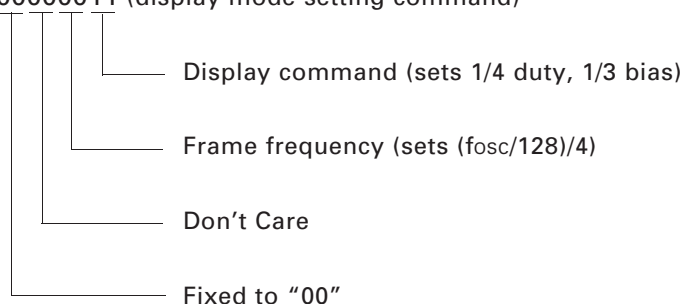

(2) Display data output

Display data is output to the μPD16430A as follows:

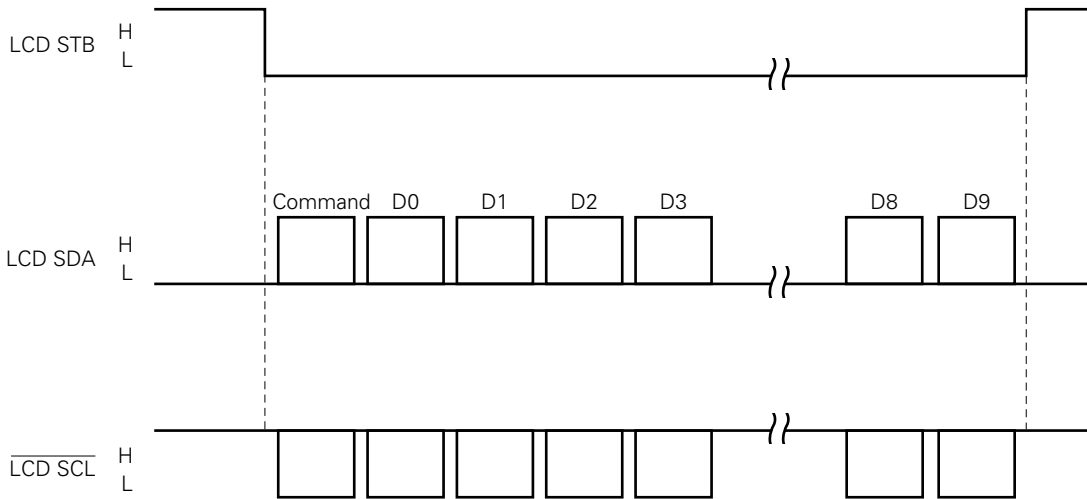

Remarks 1. Command: 10001111 (Status command)

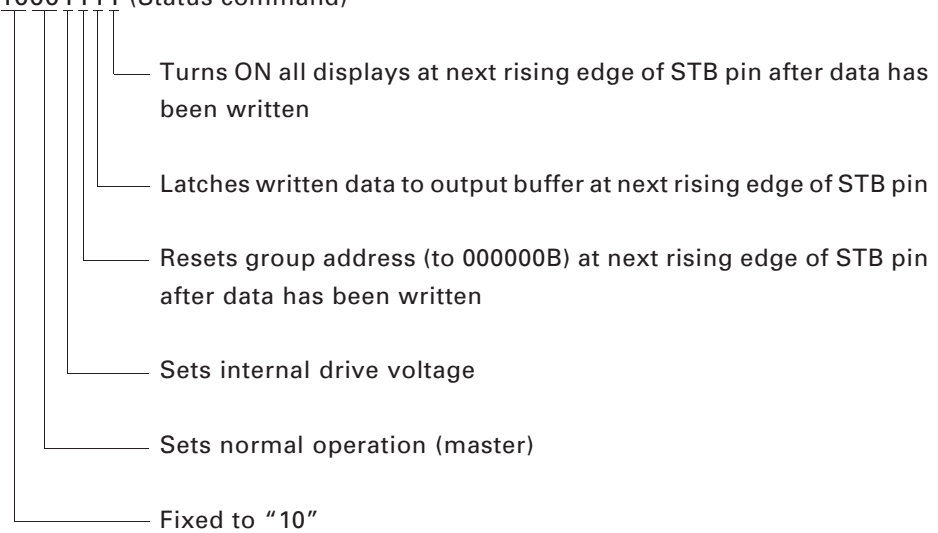

2. D0-D9 : 00000000 (display data)

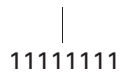

4. RDS (Radio Data System) FUNCTION

4.1 RDS Data Processing

The μ PD17006AGF-011 is provided with an RDS data decode function.

The following RDS data are supported.

- PI (Program Identification)
- PS (Program Service Name)
- PTY (Program Type)
- AF (List of Alternative Frequencies)
- EON (Enhanced Other Network)
- TP (Traffic Program Identification)
- TA (Traffic Announcement Identification)
- CT (Clock-Time and Data)

4.1.2 PS (Program Service Name)

This data is used for PS display on the LCD panel.

By inputting the same PS data two times, the PS data is determined, and is displayed on the LCD panel.

If the tuned station is an RDS broadcasting station when the tuning operation has been completed, PS display is performed at the point when the PS data has been determined (after about 3 seconds).

Once the PS data has been input, the already input PS data is displayed even if no more PS data can be input.

4.1.3 PTY (Program Type)

This data is used to identify alarms and to display program types.

By inputting an alarm during RDS broadcasting station reception, the radio mode is set if the tape/CD mode is set, and the TA/DK pin (pin 25) is made low.

A program type can be displayed and searched for by pressing the key (for details, refer to the description of the key).

Program types are assigned as shown in the table below.

The characters in parentheses () in this table are displayed on the 14-segment portion on the LCD panel when the corresponding program type is selected.

Table 4-1 Program Type

No.	Program Type	
1	No program type	(NONE)
2	News	(NEWS)
3	Current affairs	(AFFAIRS)
4	Information	(INFO)
5	Sports	(SPORT)
6	Education	(EDUCATE)
7	Drama	(DRAMA)
8	Culture	(CULTURE)
9	Science	(SCIENCE)
10	Variety	(VARIED)
11	Pop music	(POP M)
12	Rock music	(ROCK M)
13	M.O.R music	(M.O.R. M)
14	Light classic music	(LIGHT M)
15	Serious classic music	(CLASSICS)
16	Other music	(OTHER M)

4.1.4 AF (List of Alternative Frequency)

This data is used as an alternative frequency list.

(1) Inputting an AF list

Up to 25 AF lists can be input. If more than 25 AF lists are sent, they are overwritten from the top of the list.

The AF function supports both METHOD A and METHOD B.

If lists are sent by METHOD B in pairs and in descending order, the following processing is performed:

- (a) If the area cover code of the PI code of the station currently received is '1' to '3', the pair in descending order is included in the list.
- (b) Other than above, the pair in descending order is not included in the list.

Fig. 4-2 Inputting an AF List (1/3)

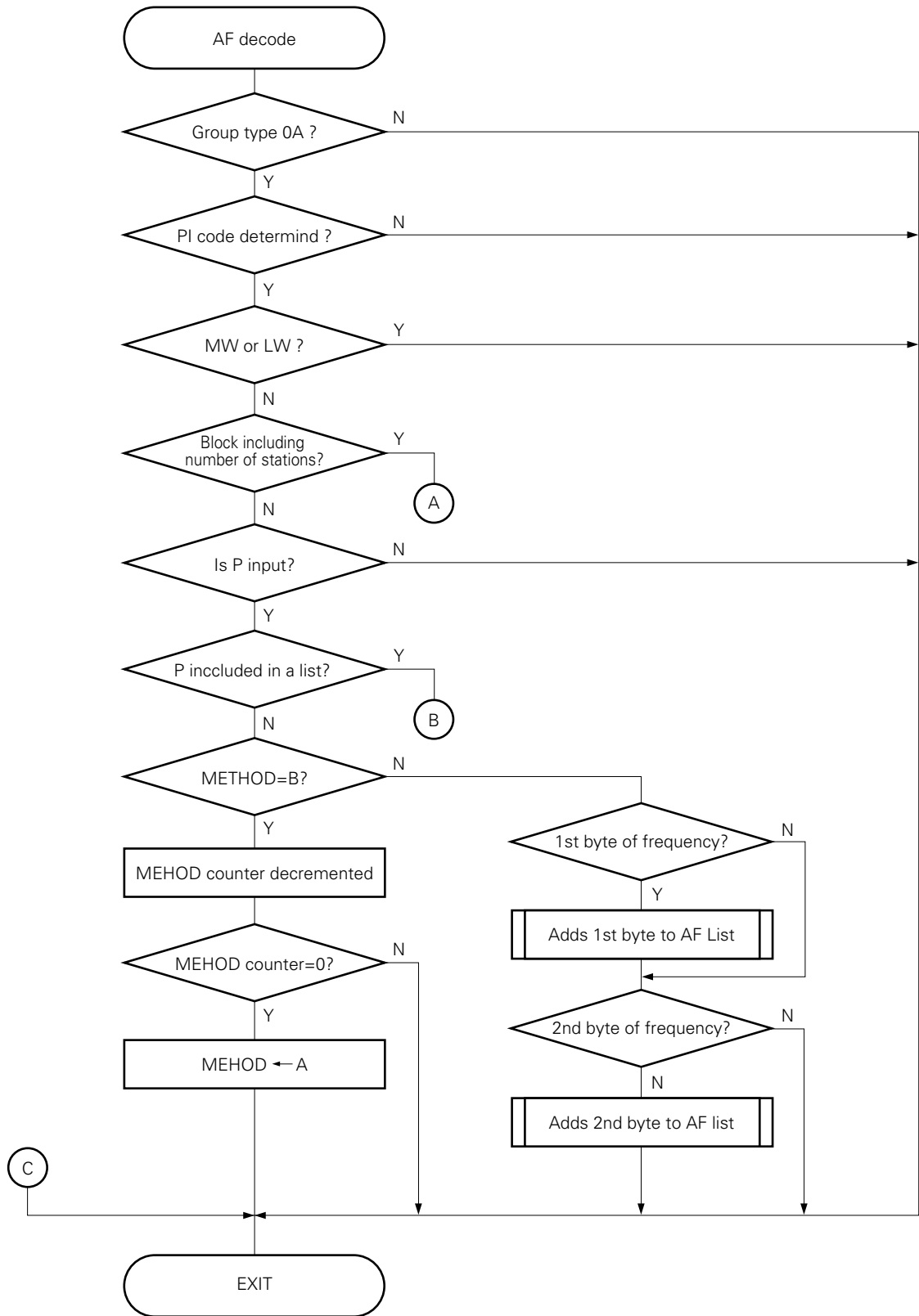

Fig. 4-2 Inputting an AF List (2/3)

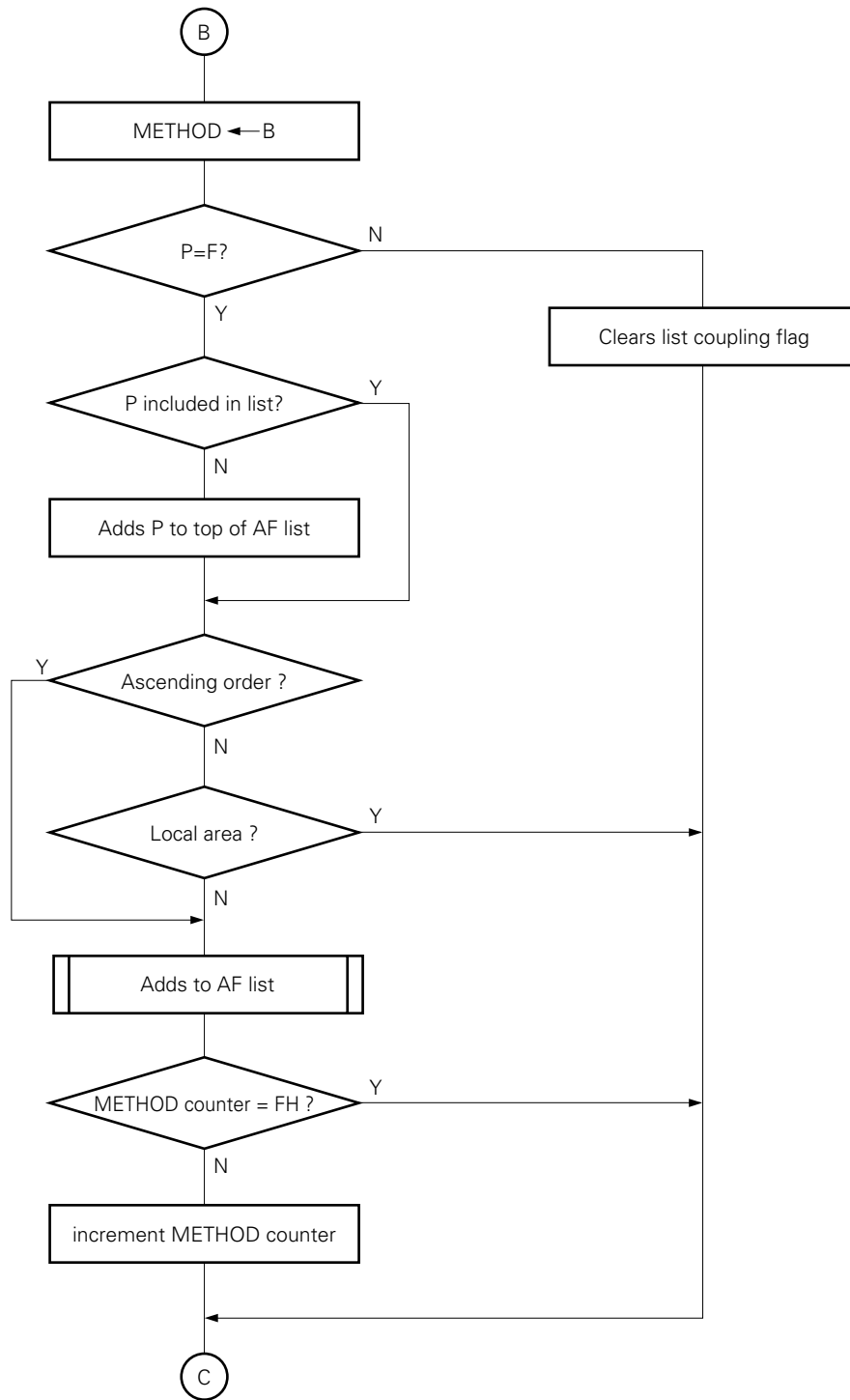
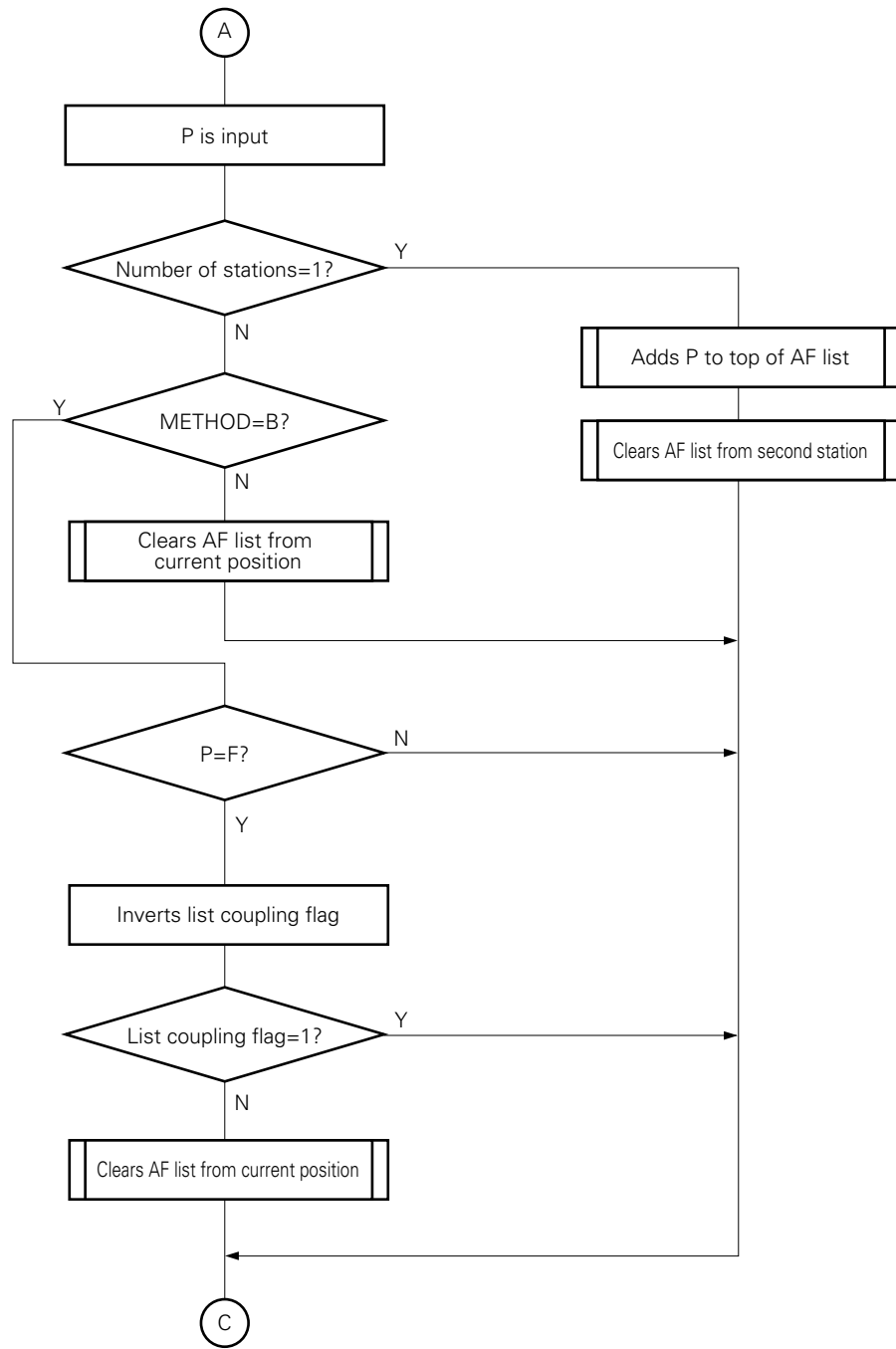

Fig. 4-2 Inputting an AF List (3/3)



P : Frequency included in block that includes number of stations
 F : Tuning frequency

(2) AF operation

There are two operation procedures for AFs: AF operation 1 and AF operation 2.

AF operations 1 and 2 are performed as follows (the condition under which AF operation 1 is performed is in FM band and when an RDS station is called):

- **AF operation 1**

- At CE reset
- When band is changed
- When preset memory is read
- When tuner is selected by sound selector (except while tuner is performing seek operation)

- **AF operation 2**

- When electric field intensity of broadcasting currently received drops below a specific level during RDS station reception

The AF operations are described below.

(a) AF operation 1

AF selection is performed by the following procedure if the FM band is selected, and the station called was an RDS station, when CE reset is effected, when the band is changed, when the preset memory is read, or when the tuner is selected by the sound selector (except while the tuner is performing a seek operation).

- ① The AF memories (of up to 8 stations) corresponding to the called RDS station are sorted in order of frequency.
- ② The SD pin is checked starting from the highest frequency. The signal meter level at which the broadcasting station is detected is stored.
- ③ AF selection is performed starting from the highest signal meter level, based on the detection result in ②.
- ④ If an RDS station is detected as a result of AF selection, the PI code is checked.

At this time, the PI code is checked as follows:

{	When the region mode is selected because initial setting diode REGEN = 1 and by the
	<div style="border: 1px solid black; display: inline-block; padding: 2px 5px;">REGION</div> key, coincidence of a 12-bit PI code except the area cover code of the PI code is
}	detected; otherwise, coincidence of a 16-bit PI code is detected.

When detection of coincidence of this PI code is successful, the AF operation is completed, and an RDS station is received.

- ⑤ If AF selection fails in ④, the RDS mode is checked. A PI search operation is performed when the RDS mode is selected (for the PI search operation, refer to (3) PI search operation). When the RDS mode is not selected, the station received before AF selection is retained. If a preset memory number is being displayed at this time, it is extinguished.

(b) AF operation 2

This operation is valid when the RDS mode is selected.

It denotes an AF operation that is performed when receiving an RDS station and the electric field intensity of the station currently being received drops below a specific level.

The start condition for AF operation 2 is as follows:

● **AF operation 2 start condition**

The electric field intensity of the broadcast currently being received is input from the S-METER pin (pin 5), and the data error level is input from S-QUALITY pin (pin 6). These values are converted into digital values, which are classified as follows:

A/D value of signal meter $L \leq 48H < M \leq 80H < H$

A/D value of signal quality $L \leq 50H < H$

Caution When the signal quality is not used, fix the S-QUALITY pin (pin 6) to the low level.

Depending on the combination of the classified signal meter and signal quality values, the following AF operation is performed:

- **When initial setting diode DEV.SEL = 0 (DEV.LEVEL is ignored)**

Signal Quality \ Signal Meter	H	L
H	A	A
M	A	B
L	B	C

- **When initial setting diode DEV.SEL = 1 (DEV.LEVEL is used)**

Signal Quality \ Signal Meter	H	L
H	A	D
M	D	D
L	B	C

A : AF operation is not performed.

B : AF operation 2-1 is performed.

C : AF operation 2-2 is performed.

D : AF operation 2-1 is performed if DEV.LEVEL (pin 74) outputs a low level and if 5 seconds or more has passed since the previous AF selection operation.

(c) **AF operation 2-1**

- **When initial setting diode AFSEL = 0**

The AF of each station is changed every 5 seconds. If changing the AF fails, the original station is retained.

- **When initial setting diode AFSEL = 1**

The AF of each station is changed at time intervals of 1 to 30 seconds generated at random. If changing the AF fails, the original station is retained.

(d) AF operation 2-2

• When initial setting diode AFSEL = 0

AF is selected by the following procedure:

- ① The AF list currently received (up to 25 stations) is sorted in order of frequency.
- ② The SD pin is checked from the highest frequency, and up to eight stations of signal meter levels are stored when a station is detected.
- ③ Based on the result in ②, the AF is selected starting from the station with the highest signal meter level.
- ④ If an RDS station is detected in the course of AF selection, the PI code is checked.

At this time, the PI code is checked as follows:

When the region mode is selected because the initial setting diode REGEN = 1 and the REGION key is asserted, coincidence of the 12-bit PI code excluding the area cover code of the PI code is detected; otherwise, coincidence of a 16-bit PI code is detected.

The AF operation is completed when detection of coincidence of the PI code is successful, and an RDS station is received.

- ⑤ If AF selection fails in ④, the station before AF selection was performed is retained.

• When initial setting diode AFSEL = 1

The AF of each station is changed every 5 seconds. If changing the AF fails, the original station is retained.

(3) PI search operation

If AF selection fails when AF operation 1 has been performed, and RDS mode is set, a PI search operation is performed by the following procedure:

- ① Stations are searched in the up direction in 100-kHz steps to make a pass through the band, starting from the frequency received before failure of AF selection.
- ② A station is detected. If it is not an RDS station, proceed to the next step. If it is an RDS station, the PI code is checked.

The PI code is checked as follows:

When the region mode is selected because the initial setting diode REGEN = 1 and the REGION key is asserted, coincidence of the 12-bit PI code excluding the area cover code of the PI code is detected; otherwise, coincidence of a 16-bit PI code is detected.

- ③ If detection of coincidence of the PI code is successful in ②, the AF operation is completed, and the station is received.
- ④ If detection of coincidence of the PI code fails in ②, and if coincidence of the PI code is not detected after the PI search is performed, passing through the band, the frequency before the PI search is retained, and the AF operation is completed.

4.1.5 EON (Enhanced Other Network)

The EON information sent as block 3 of group type 14A uses the AF list of the network of the other station and mapped FM frequency.

Group type 14A and data are input by the following procedure:

- ① The PI code same as the PI code stored in block 4 of the data sent by 14A is searched from the pool memory.
- ② If the PI code that coincides with the PI code stored in block 4 is found, the next frequency of block 3 of the data sent by 14A is registered in the AF list attached to that PI code.
 - AF list sent by Usage Code 4
 - Mapped FM frequency sent by Usage Code 5-8

Remark The frequency is registered in ② as follows:

● **Registering an AF list sent by Usage Code 4**

Up to eight stations are input to a work area.

If the PI code sent by block 4 of 14A is changed, or if the receive frequency is changed, the data in the work area is updated to accept the AF list of the PI code that coincides. If a PI code that coincides is not found, the work area is updated to be a new pool memory. If there is no vacant pool memory, pool memories are overwritten starting from the oldest one that is not registered to preset memory.

● **Registering an AF list sent by Usage Codes 5 to 8**

(a) If a PI code that coincides already exists in pool memory

The AF list in the pool memory is directly updated (refer to the figure below).

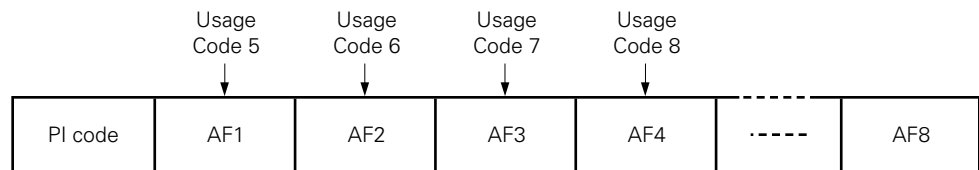

The storage positions corresponding to Usage Codes 5 to 8 are predetermined as shown in the above figure. AF1 takes the highest priority for AF selection. In this case, even if the AF list in a pool memory has been already registered, the pool memory is overwritten when Usage Codes 5 to 8 are input.

(b) If the PI code that coincides is not in pool memory

In this case, the same assumption is made as when a PI code that coincides is missing in the case of Usage Code 4.

For traffic information interrupt operation of a station other than the received station, refer to 4.1.6 TP, TA.

4.1.6 TP (Traffic Program Identification), TA (Traffic Announcement Identification)

These data are used to identify a traffic information station or traffic information announcement.

A traffic information station is identified as follows:

- When TP = 1
- When TP = 0 and TA = 1

A traffic information announcement is identified as follows:

- **When broadcasting of TP = 1**

It is judged that traffic information is received when TA = 1.

- **When TP = 0 and TA = 1**

Traffic information is provided by the station whose PI is included in the group type 14B that was sent.

Traffic information is selected as follows:

- **When TP = 1**

When TA = 1, the $\overline{\text{TA/DK}}$ pin (pin 25) outputs low level. If tape/CD mode is set at this time, radio mode is set.

When TA = 0, the $\overline{\text{TA/DK}}$ pin outputs high level, and the original mode is set.

- **When TP = 0 and TA = 1**

Group type 14B is sent. When the network TA of the other station = 1, and the station given by PI indicated in block 4 is stored in a preset or pool memory, all the AF lists are checked. The station with the highest signal meter level from the stations whose PI coincide is selected and received.

If no station whose PI coincides is found, a PI search operation is performed (refer to **4.1.4 (3) PI search operation**).

In radio mode, mute is canceled when a new broadcast is selected, and that broadcast is received. The TP and TA of that broadcast are then checked. If both TP and TA do not become 1 within 4 seconds, the original broadcast is received. In this case, selection by 14B for that PI is not made for 4 seconds.

When both TP and TA become 1, the $\overline{\text{TA/DK}}$ pin outputs the low level.

In the tape/CD mode, the TP and TA of the broadcast that has been selected are checked. If both TP and TA do not become 1 within 4 seconds, the original broadcast is received.

If both TP and TA become 1, $\overline{\text{TA/DK}}$ pin outputs low level, and radio mode is set.

In both the radio and tape/CD modes, if TP = 1 and TA = 0 later, the $\overline{\text{TA/DK}}$ pin outputs high level and the original station is received.

At this time, even if 14B is received, if TA of the network of the other station = 0, the reception mode continues.

If the RDS signal is no longer received after the new broadcast is selected, the original broadcast is received.

- **Alarm when a traffic information station is no longer received**

- (1) **If 30 seconds have passed since a received traffic information station is no longer judged as such (except when traffic information from another station is received by EON)**

- In radio mode : The SK mute pin (pin 23) outputs low level, and an alarm is output (from pin 28) 3 seconds later.
- In a mode other than radio mode: A Traffic information station is searched for throughout the band.

- (2) **If the frequency is changed while ALARM (pin 28) is being output (if the newly selected broadcast is not traffic information)**

When the alarm stops temporarily and mute (pin 24) is canceled, SK mute is output overlapped with that mute, and alarm is output 3 seconds later.

- (3) **If CE goes high and the received station is judged not to be a traffic information station, and a traffic information station is not detected 3 seconds after mute has been canceled**

An operation same as (1) above is performed.

- (4) **If another mode is selected during alarm output**

Operation the same as in a mode other than radio mode in (1) above is performed.

- (5) **When radio mode is set while a seek operation is being performed in a mode other than radio mode**

The seek up operation continues, and operation the same as in a mode other than radio mode in (1) above is performed.

- (6) **When traffic information mode is canceled while a seek up operation is being performed in a mode other than radio mode**

The seek up operation continues, and the normal auto tuning operation is performed (only RDS stations are received when RDS mode is selected).

● **Searching for a traffic information station**

When auto tuning is performed in the traffic information mode, a judgment is made 400 to 500 ms after auto tuning is temporarily stopped by SD as to whether the received station is a traffic information station, and only the traffic information station is stopped.

The above traffic information operations are performed by using RDS mode even when RDS mode is not selected.

4.1.7 CT (Clock-Time and Data)

This data is used to adjust the timer.

The time broadcast is the Coordinated Universal Time (UTC) recommended by the CCIR. It is therefore converted to local time and used as timer data.

By inputting a time announcement, the value of the internal timer of the μPD17006AGF-011 is adjusted to the value of local time.

When the CTADJ switch of the initial setting diode = 1 (shorted with diode), the time can be always adjusted by inputting time announcement information. Each time the time is adjusted, the seconds are cleared to 0.

Note that an adjustment can be made from time announcement information even while the timer is being adjusted by the timer being adjustment key.

Whether time adjustment is made by using the time adjustment data is set by the NOCLK, CTSRT, and CTADJ switches of the initial setting diode.

5. MODE TRANSITIONS

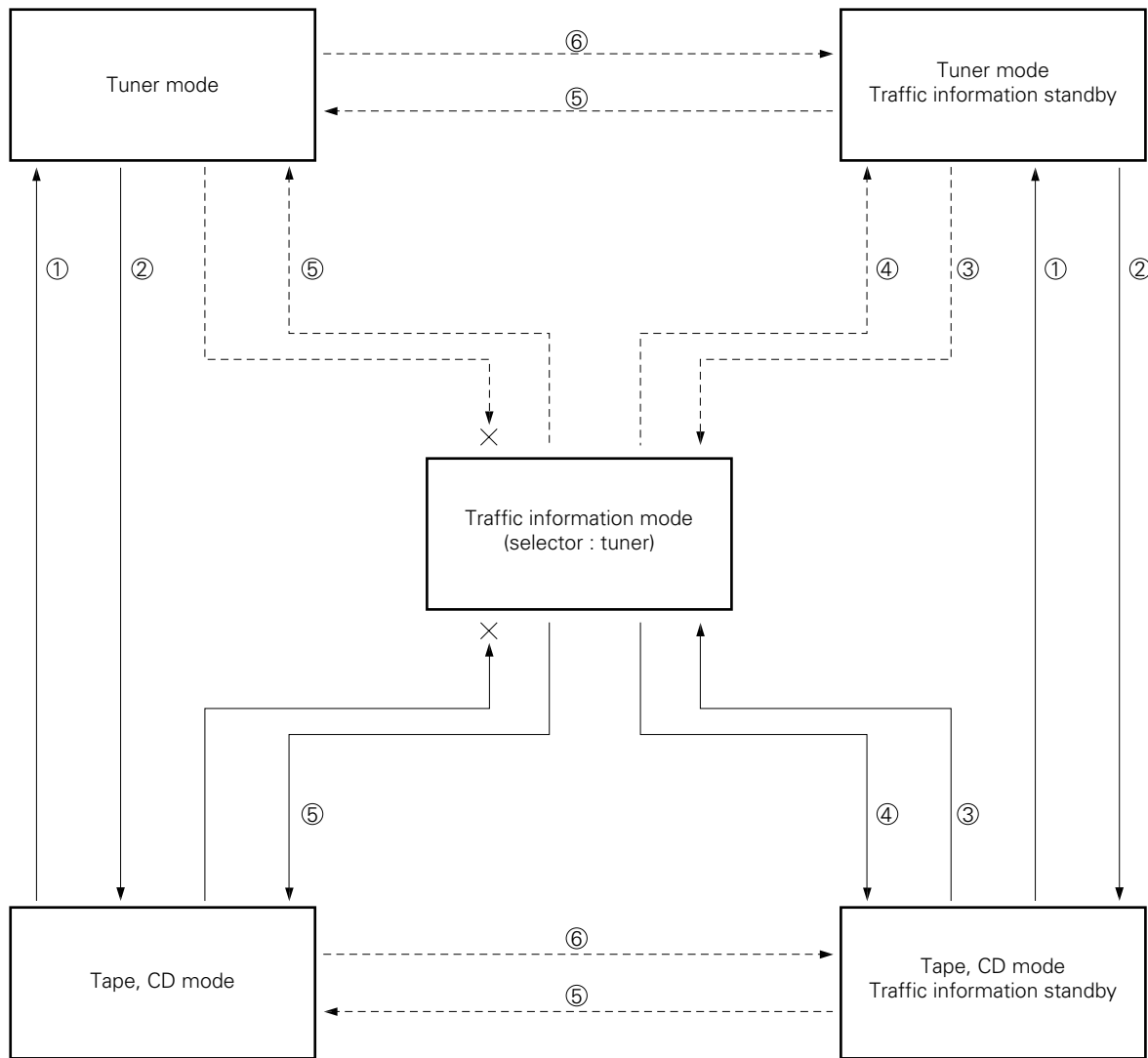

- Remarks**
- : Actual mode changes (MODE pin output, mute, etc.)
 - - - - - : Actual mode does not change
 - × ← : Change to this mode cannot be made.
 - ① : TAPE pin = low level, and CD mode OFF
 - ② : TAPE pin = high level, and CD mode ON
 - ③ : TA or DK ON
 - ④ : TA or DK OFF
 - ⑤ : TP/SK mode OFF
 - ⑥ : TP/SK mode ON

6. LCD PANEL

6.1 LCD Panel

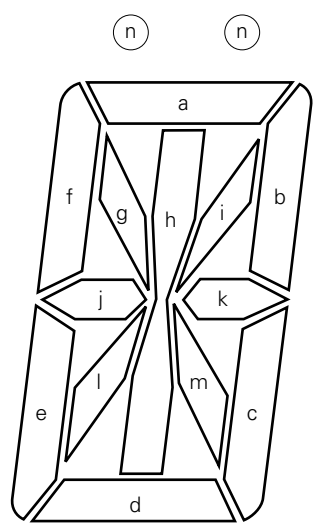
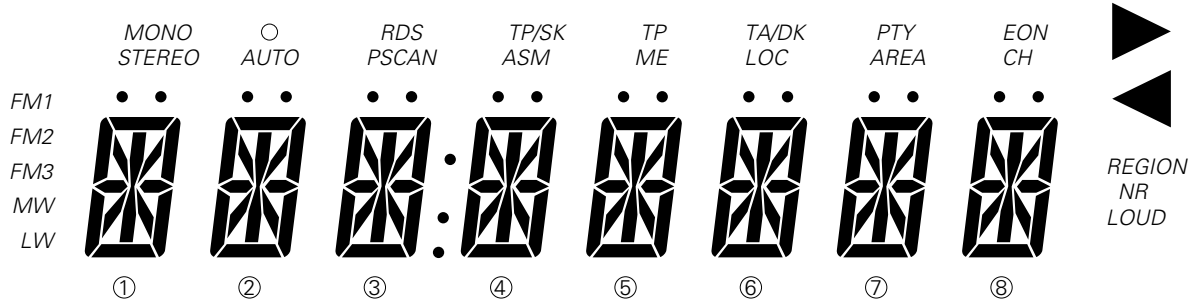

6.2 LCD Pin Assignment (1/2)

Common Segment	COM ₀ (63)	COM ₁ (64)	COM ₂ (65)	COM ₃ (66)
LCD ₀ (1)	FM3	MW	LW	–
LCD ₁ (2)	–	–	–	–
LCD ₂ (3)	FM2	① f	① e	FM1
LCD ₃ (4)	① g	① j	① l	–
LCD ₄ (5)	① a	① h	① d	LOUD
LCD ₅ (6)	① i	① k	① m	–
LCD ₆ (7)	① n	① b	① c	–
LCD ₇ (8)	–	–	–	–
LCD ₈ (9)	STEREO	② f	② e	MONO
LCD ₉ (10)	② g	② j	② l	–
LCD ₁₀ (11)	② a	② h	② d	–
LCD ₁₁ (12)	② i	② k	② m	–
LCD ₁₂ (13)	② n	② b	② c	○
LCD ₁₃ (14)	–	–	–	–
LCD ₁₄ (15)	AUTO	③ f	③ e	RDS
LCD ₁₅ (16)	③ g	③ j	③ l	–
LCD ₁₆ (17)	③ a	③ h	③ d	–
LCD ₁₇ (18)	③ i	③ k	③ m	–
LCD ₁₈ (19)	③ n	③ b	③ c	•
LCD ₁₉ (20)	–	–	–	–
LCD ₂₀ (21)	PSCAN	④ f	④ e	:
LCD ₂₁ (22)	④ g	④ j	④ l	–
LCD ₂₂ (23)	④ a	④ h	④ d	REGION
LCD ₂₃ (24)	④ i	④ k	④ m	–
LCD ₂₄ (25)	④ n	④ b	④ c	–
LCD ₂₅ (26)	–	–	–	–
LCD ₂₆ (27)	ASM	⑤ f	⑤ e	TP/SK
LCD ₂₇ (28)	⑤ g	⑤ j	⑤ l	–
LCD ₂₈ (29)	⑤ a	⑤ h	⑤ d	–
LCD ₂₉ (30)	⑤ i	⑤ k	⑤ m	–
LCD ₃₀ (31)	⑤ n	⑤ b	⑤ c	TP
LCD ₃₁ (32)	–	–	–	–
LCD ₃₂ (35)	ME	⑥ f	⑥ e	◀
LCD ₃₃ (36)	⑥ g	⑥ j	⑥ l	–
LCD ₃₄ (37)	⑥ a	⑥ h	⑥ d	–
LCD ₃₅ (38)	⑥ i	⑥ k	⑥ m	–

Remarks 1. – : not used

2. Figures in () are the pin numbers of the μPD16430A.

6.2 LCD Pin Assignment (2/2)

Common Segment	COM ₀ (63)	COM ₁ (64)	COM ₂ (65)	COM ₃ (66)
LCD ₃₆ (39)	⑥ n	⑥ b	⑥ c	TA/DK
LCD ₃₇ (40)	–	–	–	–
LCD ₃₈ (41)	LOC	⑦ f	⑦ e	▶
LCD ₃₉ (42)	⑦ g	⑦ j	⑦ l	–
LCD ₄₀ (43)	⑦ a	⑦ h	⑦ d	–
LCD ₄₁ (44)	⑦ i	⑦ k	⑦ m	–
LCD ₄₂ (45)	⑦ n	⑦ b	⑦ c	PTY
LCD ₄₃ (46)	–	–	–	–
LCD ₄₄ (47)	AREA	⑧ f	⑧ e	EON
LCD ₄₅ (48)	⑧ g	⑧ j	⑧ l	–
LCD ₄₆ (49)	⑧ a	⑧ h	⑧ d	–
LCD ₄₇ (50)	⑧ i	⑧ k	⑧ m	–
LCD ₄₈ (51)	⑧ n	⑧ b	⑧ c	CH
LCD ₄₉ (52)	–	NR	–	–



Remarks 1. – : not used



2. Figures in () are the pin numbers of the μPD16430A.

6.3 Display

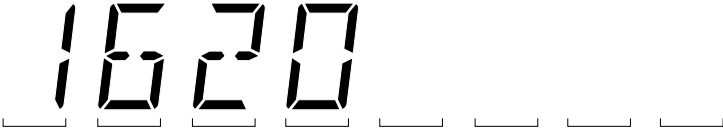
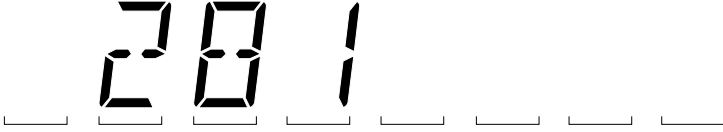
Each display indicator and segment on the LCD panel is described below.

Display	Description
MONO	Indicates forced monaural sound output mode. Display is inverted when <input type="checkbox"/> MONO key is pressed while FM band is being received in radio mode.
○	Indicates that the currently received station is an RDS station. Lights when an RDS station is received in the FM band.
RDS	Indicates RDS mode. Lights in RDS mode in FM band.
TP/SK	Indicates TP/SK mode. Lights in TP/SK mode in FM band.
TP	Indicates that currently received station is station that broadcasts traffic information. Lights when TP signal of RDS station or SK signal of VF station is detected.
TA/DK	Indicates that currently received station is broadcasting traffic information. Lights when TA signal of RDS station or DK signal of VF station is detected.
EON	Indicates that currently received station is EON station of RDS station. Lights when traffic information from EON station is being received in TP/SK mode.
AREA	Lights when currently received station is RDS station and when region is displayed on LCD panel.
STEREO	Indicates that stereo signal is being input. Lights when STEREO pin is low in FM band. Always remains dark in MONO mode.
PSCAN	Indicates that preset memory scan operation is in progress. Lights when preset memory scan operation is started by <input type="checkbox"/> PSCAN/ASM key.
ASM	Indicates that auto store memory operation is in progress. Lights when auto store memory operation is started by <input type="checkbox"/> PSCAN/ASM key.
ME	Indicates that preset memory is written. Lights when data write to preset memory is started by <input type="checkbox"/> ME key.
LOC	Indicates that setting of LOCAL/DX is LOCAL. Display is inverted when <input type="checkbox"/> LOC key is pressed in radio mode.
CH	Indicator indicating channel of preset memory number. Lights while channel number is displayed with 14 segments.
FM1 FM2 FM3 MW LW	Indicates received radio band.
AUTO	Indicates that tuning mode of radio is AUTO (seek). Remains dark (MANUAL) when shift mode is selected by <input type="checkbox"/> SHIFT key in radio mode.
REGION	Indicates that region station is also supported during AF selection. Display is reversed by pressing <input type="checkbox"/> REGION key.
PTY	Indicates that PTY mode is selected. Lights while PTY code is displayed with 14 segments or during PTY search operation.

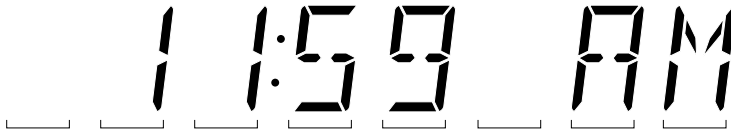
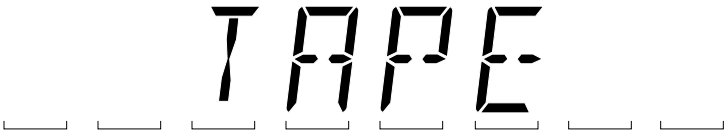
Display	Description
NR	Indicates noise reduction mode. Display is inverted when <input type="checkbox"/> NR key is pressed in tape mode.
▶ ◀	Indicate tape running directions. “▶” lights when R/L pin is low in tape mode, and “◀” lights when R/L pin is high.
LOUD	Indicates output status of LOUD pin. Display is inverted when <input type="checkbox"/> LOUD key is pressed.
14-segment display area	<p>Displays following:</p> <ul style="list-style-type: none"> • Receive frequency • Time • Tape • CD • PS (Program Service Name) <p>● Receive frequency display</p> <p>(1) FM band (108.00 MHz)</p> <div style="text-align: center;">  <p>108.00</p> </div> <p>(2) MW band (1620 kHz)</p> <div style="text-align: center;">  <p>1620</p> </div> <p>(3) LW band (281 kHz)</p> <div style="text-align: center;">  <p>281</p> </div> <p>● Time display</p> <p>12-hour or 24-hour display can be selected by CLK24 switch of initial setting diode. “: (colon)” can be flashed at 1 Hz by FLASH switch of initial setting diode.</p> <p>(1) When CLK24 = 1 (9:00 p.m.)</p> <div style="text-align: center;">  <p>2 1:00</p> </div>

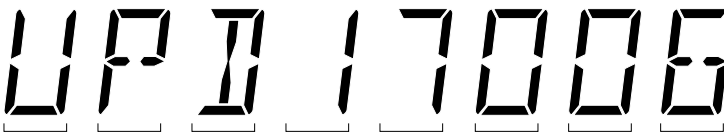
Display	Description
14-segment display area	<p>(2) When CLK24 = 0 (9:00 p.m.)</p>  <p>(3) When CLK24 = 0 (11:59 a.m.)</p>  <p>● Tape display Following message is displayed in tape mode.</p>  <p>● CD display Following message is displayed in CD mode.</p>  <p>● PS display 8-digit PS is displayed when PS data is input.</p> 

7. MUTE OUTPUT TIMING CHART

7.1 Preset Memory Read

The specified preset memory is read when any of the **M1** to **M5** keys is pressed for less than 2 seconds while in tuner mode with initial setting diode MESEL = 0, or when any of the **M1** to **M5** keys is pressed in a mode other than memory write enable mode with MESEL = 1.

A mute timing diagram showing the preset memory read operation is given below.

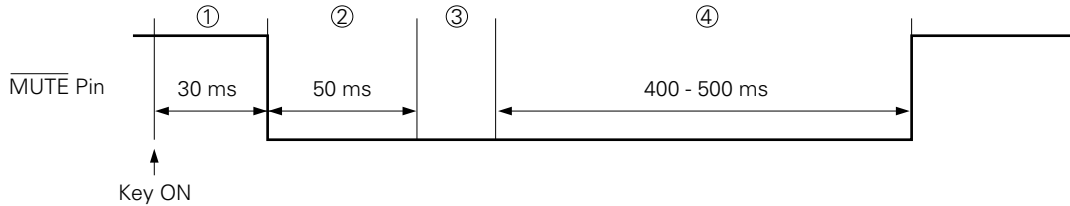

- ① : Key ON chattering prevention (key OFF time when MESEL = 0)
- ② : Leading mute
- ③ : Division ratio setting
- ④ : Trailing mute

7.2 Preset Scan

The preset scan operation is started when the **PSCAN/ASM** key is pressed for less than 2 seconds in the tuner mode with initial setting diode FUNC = 0, or when the **M1** key is pressed for less than 2 seconds with FUNC = 1.

A mute timing diagram showing the preset scan operation is given below.

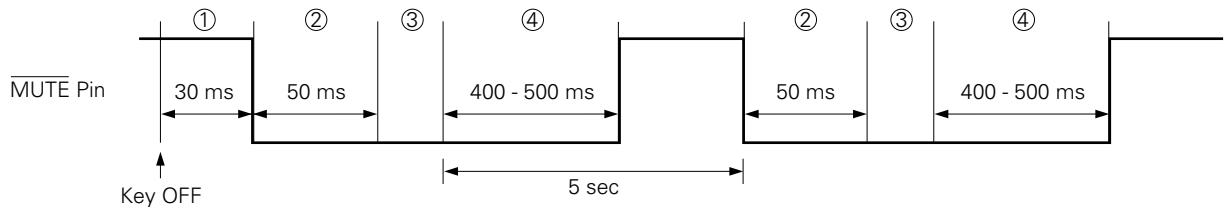

- ① : Key ON chattering prevention
- ② : Leading mute
- ③ : Division ratio setting
- ④ : Trailing mute

7.3 Seek Up/down

The operation is started when the **SEEK/MAN UP** / **SEEK DOWN** key is pressed in a mode other than shift mode in tuner mode.

If the SD level and initial setting diodes AM SD/IF and FM SD/IF are ON, the IF count is checked. When conditions for presence of a station are satisfied two times at intervals of 500 ms, the seek operation ends.

In the RDS mode and TP/SK mode, an RDS station and traffic information station are detected by operation shown in the timing chart below, after the above condition has been satisfied.

(1) Normal mode

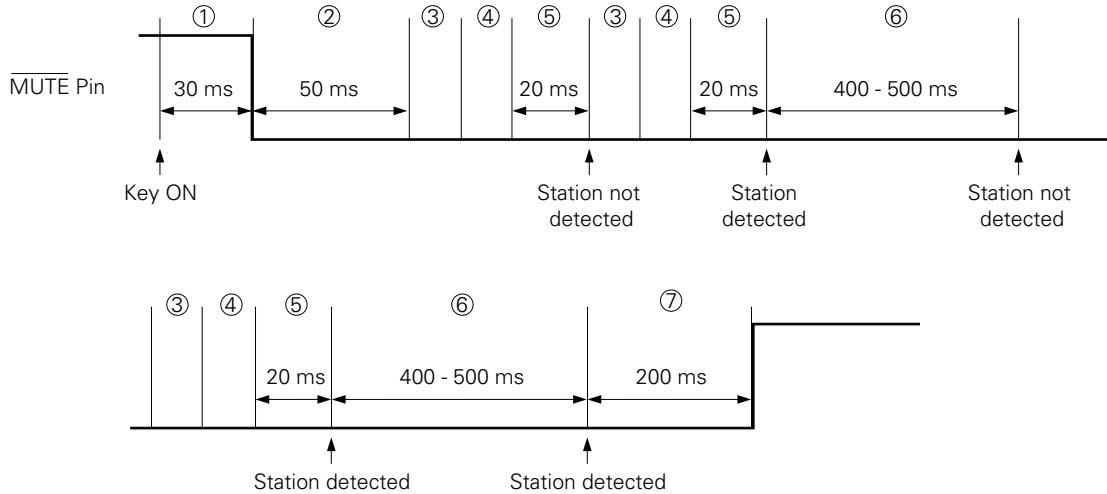

- ① : Key ON chattering prevention
- ② : Leading mute
- ③ : Division ratio setting
- ④ : PLL lock wait
- ⑤ : SD stabilization wait 1
- ⑥ : SD stabilization wait 2
- ⑦ : Trailing mute

(2) RDS mode

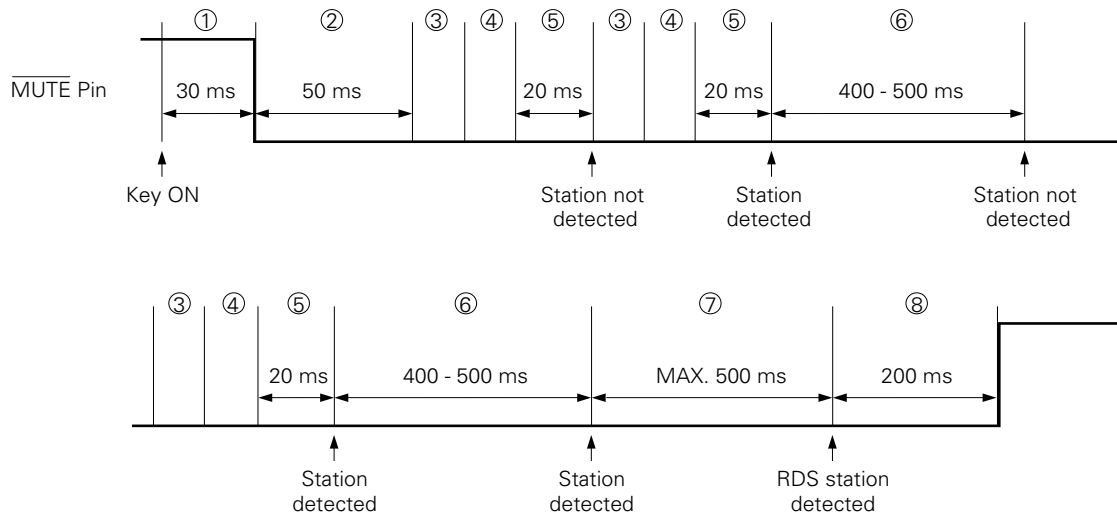

- ① : Key ON chattering prevention
- ② : Leading mute
- ③ : Division ratio setting
- ④ : PLL lock wait
- ⑤ : SD stabilization wait 1
- ⑥ : SD stabilization wait 2
- ⑦ : RDS station detection wait
- ⑧ : Trailing mute

(3) TP/SK mode

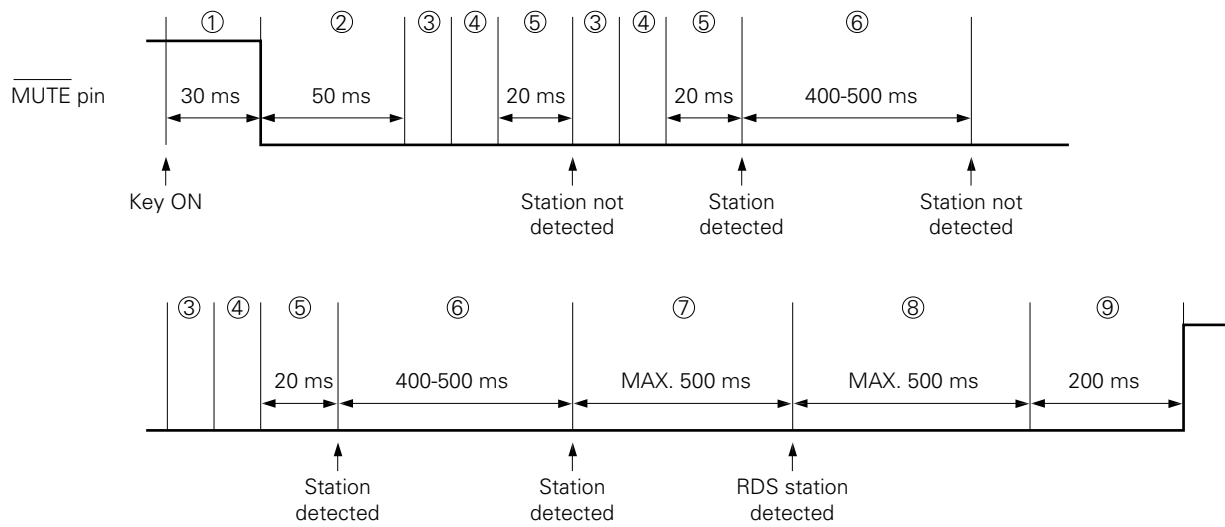

- ① : Key ON chattering prevention
- ② : Leading mute
- ③ : Division ratio setting
- ④ : PLL lock wait
- ⑤ : SD stabilization wait 1
- ⑥ : SD stabilization wait 2
- ⑦ : RDS station detection wait
- ⑧ : Traffic information station identification (TP/SK) wait
- ⑨ : Trailing mute

7.4 Manual Up/down

The operation is started when the **SEEK UP** / **SEEK DOWN** key is pressed in the tuner mode and in shift mode.

A timing chart showing the manual operation is shown below.

(1) If key is released within 0.5 second

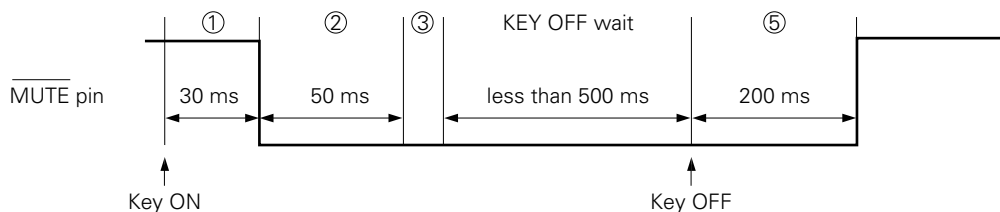

(2) If key is held down for 0.5 second or more

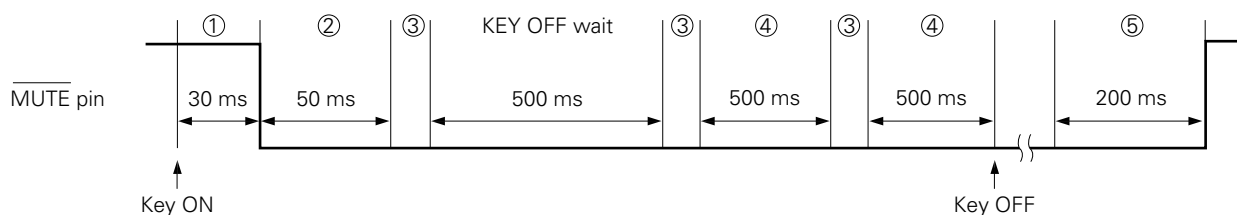

- ① : Key ON chattering prevention
- ② : Leading mute
- ③ : Division ratio setting
- ④ : Key repeat time
- ⑤ : Trailing mute

7.5 Auto Store Memory

The auto store memory operation is started when the **PSCAN/ASM** key is held down for 2 seconds or more in tuner mode with initial setting diode FUNC = 0, or when the **M1** key is held down for 2 seconds or more with FUNC = 1.

A mute timing diagram showing the auto store memory operation is given below.

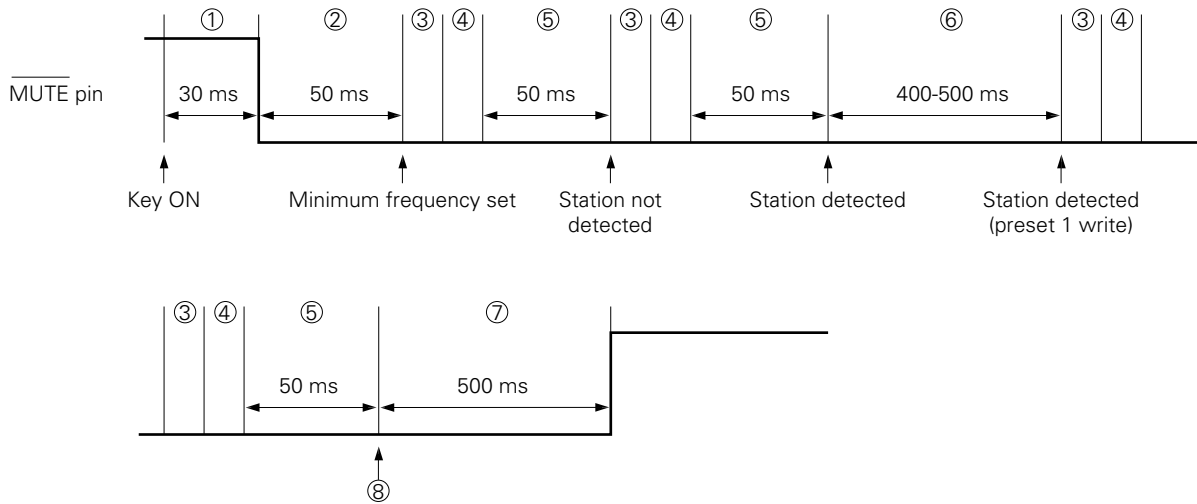

- ① : Key ON chattering prevention
- ② : Leading mute
- ③ : Division ratio setting
- ④ : PLL lock wait
- ⑤ : SD stabilization wait 1
- ⑥ : SD stabilization wait 2
- ⑦ : Trailing mute
- ⑧ : ASM end. Sorting is executed in the order of frequency, and preset memory M1 is called. If no station is detected, the frequency before the key is pressed is retained. If a station is found after stations have been written up to M5, it is compared with the SD level of the written preset, and is sorted starting from the highest SD level.

7.6 When Selecting CE

(1) When selecting CE (in tuner/CD mode)

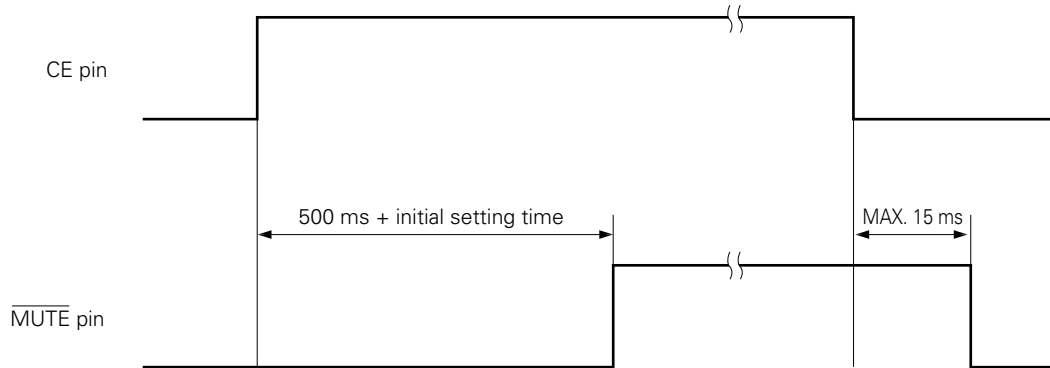

(2) When selecting CE (in tape mode)

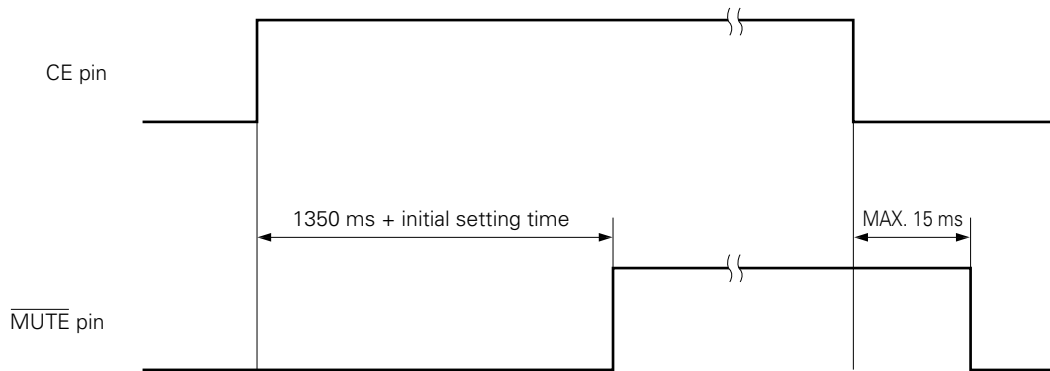

7.7 When Selecting Sound Mode (selector)

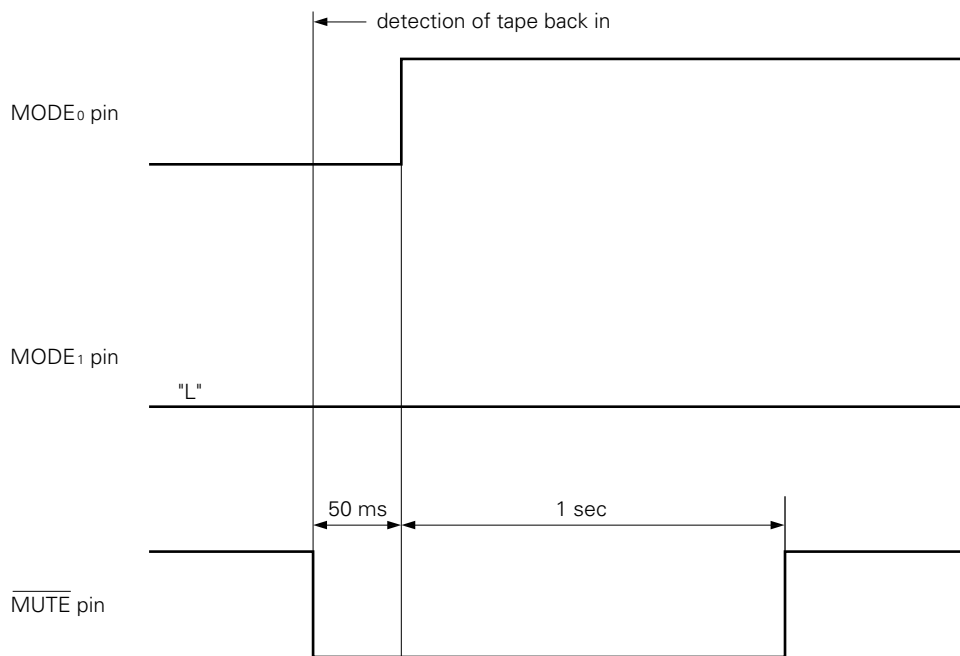

Sound mode selection mute output other than mode change within the same sound mode, such as a change between tuner mode and traffic information mode, is carried out as in the above timing (50 ms after the mute is output).

Mute output is not performed if a change is made within the same sound source, such as a change between the tuner mode and traffic information mode.

7.8 When Turning ON/OFF Detachable Panel

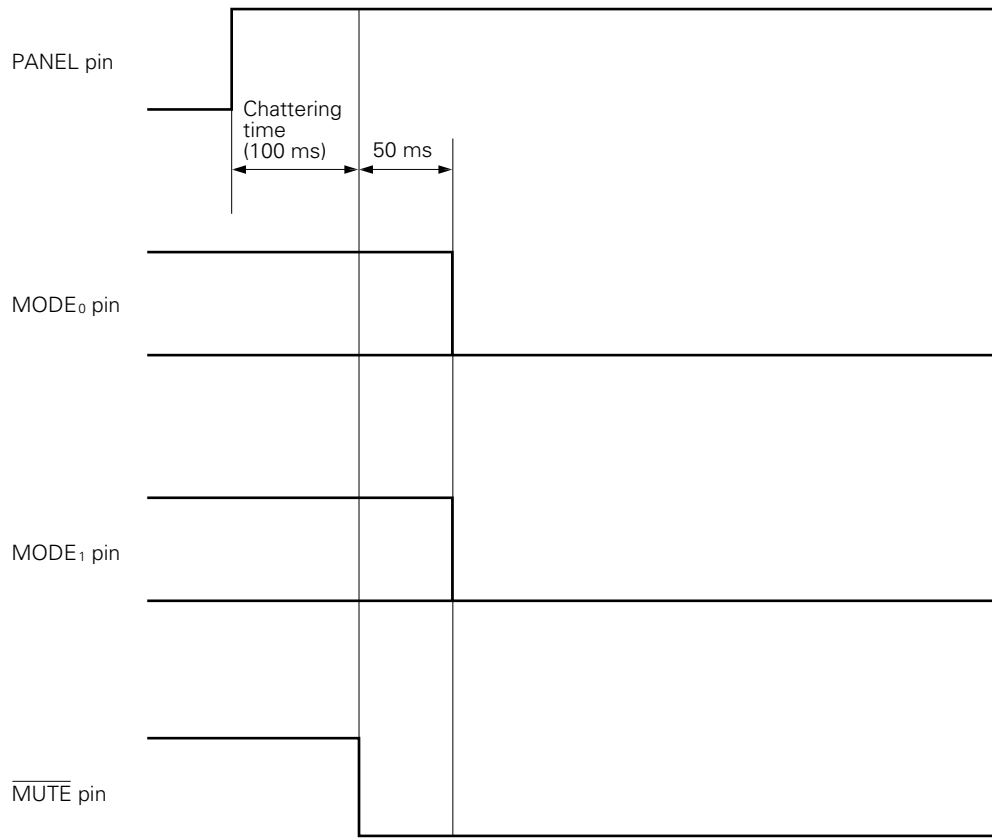

The mute output timing when the detachable panel is turned ON is the same as when the CE pin is turned ON.

8. APPLICATION CIRCUIT EXAMPLE

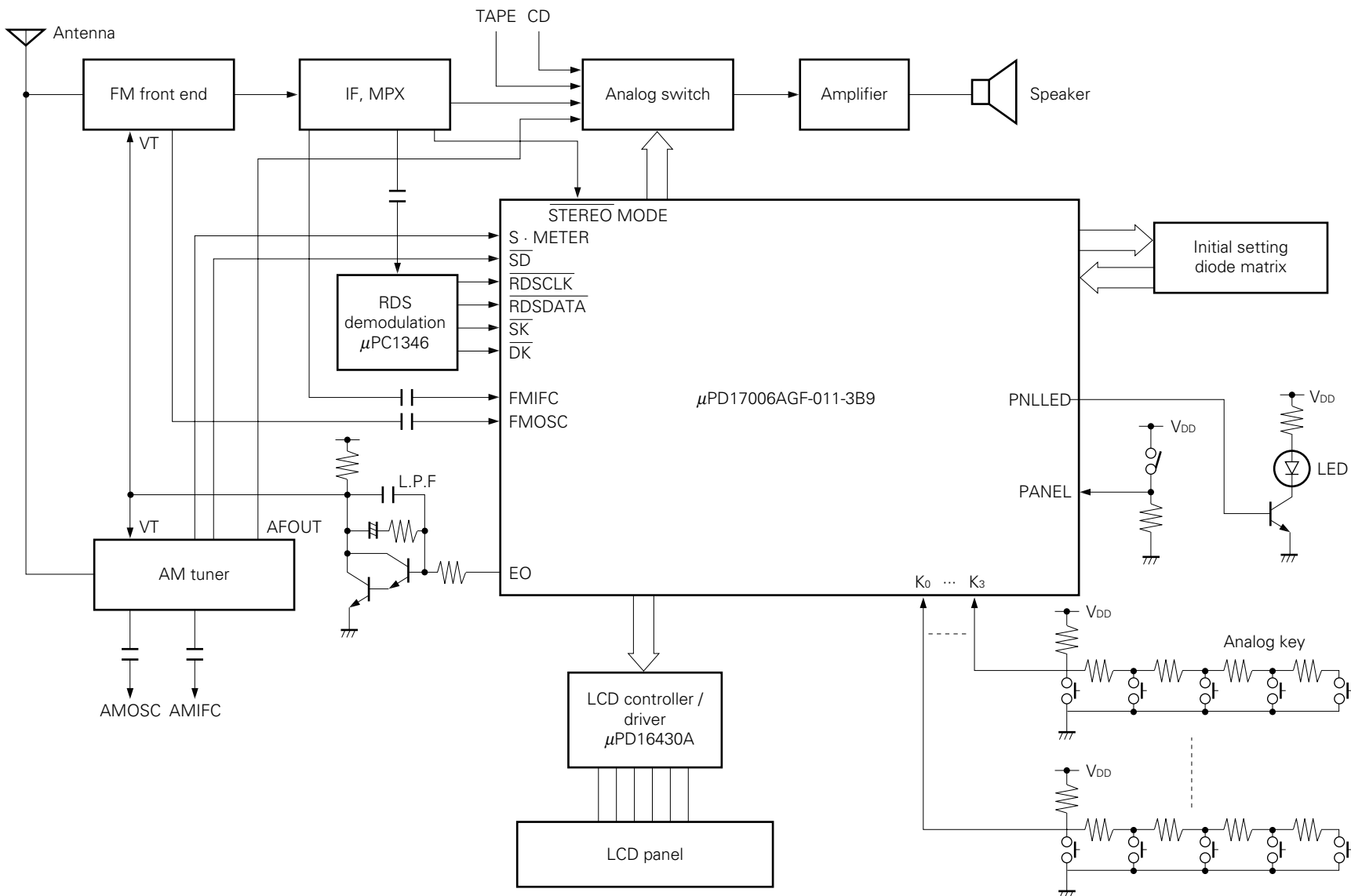

9. ELECTRICAL SPECIFICATIONS (PRELIMINARY)

Absolute Maximum Ratings (T_a = 25 ± 2 °C)

Parameter	Symbol	Condition	Rating	Unit
Supply Voltage	V _{DD}		-0.3 to +6.0	V
Input Voltage	V _I		-0.3 to V _{DD} + 0.3	V
Output Voltage	V _O	Except P0A ₂ , P0A ₃ , P1B ₁ -P1B ₃	-0.3 to V _{DD} + 0.3	V
High-Level Output Current	I _{OH}	1 pin	-10.0	mA
		Total of all pins	-20.0	mA
Low-Level Output Current	I _{OL}	1 pin	10.0	mA
		Total of all pins	20.0	mA
Output Voltage	V _{BDS1}	P1B ₁ -P1B ₃	-0.3 to +13.0	V
	V _{BDS2}	P0A ₂ , P0A ₃	-0.3 to V _{DD} + 0.3	V
Total Dissipation	P _t		450	mW
Operating Temperature	T _{opt}		-40 to +85	°C
Storage Temperature	T _{stg}		-55 to +125	°C

Caution If the absolute maximum rating of any one of the parameters is exceeded even momentarily, the quality of the product may be degraded. In other words, the product may be physically damaged if any of the absolute maximum ratings is exceeded. Be sure to use the product without exceeding these ratings.

Recommended Operating Range (T_a = -40 to +85 °C)

Parameter	Symbol	Condition	MIN.	TYP.	MAX.	Unit
Supply Voltage	V _{DD1}	When CPU and PLL operate	4.5	5.0	5.5	V
	V _{DD2}	When CPU operates and PLL is stopped	4.1	5.0	5.5	V
Data Retention Voltage	V _{DDR}	When crystal oscillator is stopped	2.3		5.5	V
Input Amplitude	V _{IN1}	V _{COL} , V _{COH}	0.5		V _{DD}	V _{p-p}
	V _{IN2}	AMIFC, FMIFC	0.5		V _{DD}	V _{p-p}
Output Voltage	V _{BDS}	P1B ₁ -P1B ₃			12.0	V
Supply Voltage Rise Time	t _{RISE}	V _{DD} : 0 → 4.1 V			500	ms

DC Characteristics (T_a = -40 to +85 °C, V_{DD} = 5 V ± 10 %)

Parameter	Symbol	Condition	MIN.	TYP.	MAX.	Unit	
Supply Current	I _{DD1}	When CPU and PLL operate VCOH pin: 150 MHz, 0.3 V _{p-p} input X _{IN} pin sine wave input (f _{IN} = 4.5 MHz, V _{IN} = V _{DD})		15.0	22.0	mA	
	I _{DD2}	When CPU operates and PLL is stopped X _{IN} pin sine wave input (f _{IN} = 4.5 MHz, V _{IN} = V _{DD})		3.5	9.0	mA	
	I _{DD3}	When CPU and PLL operate, and HALT instruction is used VCOH pin: 150 MHz, 0.3 V _{p-p} input (without HALT release condition) X _{IN} pin sine wave input (f _{IN} = 4.5 MHz, V _{IN} = V _{DD})			17.0	mA	
	I _{DD4}	When CPU operates, PLL is stopped, and HALT instruction is used (20 instructions executed every 1 ms) X _{IN} pin sine wave input (f _{IN} = 4.5 MHz, V _{IN} = V _{DD})		0.5	1.2	mA	
Data Retention Voltage	V _{DDR1}	When crystal oscillates and power failure detection by timer FF is used	4.1		5.5	V	
	V _{DDR2}	When crystal oscillation stopped and power failure detection by timer FF is used	2.3		5.5	V	
	V _{DDR3}	Data memory retention	2.0		5.5	V	
Data Retention Current	I _{DDR1}	When crystal oscillation is stopped	V _{DD} = 5 V, T _a = 25 °C		2	5	μA
	I _{DDR2}			2	20	μA	
High-Level Input Voltage	V _{IH1}	P0A ₀ , P0A ₃ , P0B ₀ , P0B ₁ , P0B ₃ , P0C ₀ -P0C ₃ , P2A ₀ -P2A ₃ , P2B ₀ -P2B ₃ , P2C ₀ -P2C ₃ , P2D ₀ -P2D ₃ , P3A ₀ -P3A ₃ , P3B ₀ -P3B ₃	0.7 V _{DD}			V	
	V _{IH2}	CE, INT ₀ , INT ₁ , P0A ₂ /SCL, P0A ₁ /SCK ₀ , P0B ₂ /SCK ₁	0.8 V _{DD}			V	
	V _{IH3}	P0D ₀ /P0D ₃	0.6 V _{DD}			V	
Low-Level Input Voltage	V _{IL}	P0A ₀ -P0A ₃ , P0B ₀ -P0B ₃ , P0C ₀ -P0C ₃ , P0D ₀ -P0D ₃ , P2A ₀ -P2A ₃ , P2B ₀ -P2B ₃ , P2C ₀ -P2C ₃ , P2D ₀ -P2D ₃ , P3A ₀ -P3A ₃ , P3B ₀ -P3B ₃ , CE, INT ₀ , INT ₁			0.2 V _{DD}	V	
High-Level Output Current	I _{OH1}	P0A ₀ , P0A ₁ , P0B ₀ -P0B ₃ , P0C ₀ -P0C ₃ , P1A ₀ -P1A ₃ , P1B ₀ , P1C ₂ , P2A ₀ -P2A ₃ , P2B ₀ -P2B ₃ , P2C ₀ -P2C ₃ , P2D ₀ -P2D ₃ , P3A ₀ -P3A ₃ , P3B ₀ -P3B ₃ , P3C ₀ -P3C ₃ , P3D ₃ , P4A ₂ , P4A ₃ V _{OH} = V _{DD} -1V	-1.0	-2.0		mA	
	I _{OH2}	EO ₀ , EO ₁ V _{OH} = V _{DD} -1V	-1.0	-3.0		mA	
Low-Level Output Current	I _{OL1}	P0A ₀ , P0A ₁ , P0B ₀ -P0B ₃ , P0C ₀ -P0C ₃ , P1A ₀ -P1A ₃ , P1B ₀ , P1C ₂ , P2A ₀ -P2A ₃ , P2B ₀ -P2B ₃ , P2C ₀ -P2C ₃ , P2D ₀ -P2D ₃ , P3A ₀ -P3A ₃ , P3B ₀ -P3B ₃ , P3C ₀ -P3C ₃ , P3D ₃ , P4A ₂ , P4A ₃ V _{OL} = 1V	1.0	2.0		mA	
	I _{OL2}	EO ₀ , EO ₁ V _{OL} = 1V	1.0	3.0		mA	
	I _{OL3}	P1B ₁ , P1B ₃ V _{OL} = 1V	1.0	2.0		mA	
	I _{OL4}	P0A ₂ , P0A ₃ V _{OL} = 1V	1.0	10.0		mA	

DC Characteristics (T_a = -40 to +85 °C, V_{DD} = 5 V ± 10 %)

Parameter	Symbol	Condition	MIN.	TYP.	MAX.	Unit
High-Level Input Current	I _{IH1}	with VCOH pin pulled down V _{IH} = V _{DD}	0.1	0.8		mA
	I _{IH2}	with VCOL pin pulled down V _{IH} = V _{DD}	0.1	0.8		mA
	I _{IH3}	with X _{IN} pin pulled down V _{IH} = V _{DD}	0.1	1.3		mA
Output Off Leakage Current	I _{L1}	P0A ₂ , P0A ₃ V _{OH} = V _{DD}			1	μA
	I _{L2}	P1B ₁ -P1B ₃ V _{OH} = 12 V			1	μA
	I _{L3}	EO ₀ , EO ₁ V _{OH} = V _{DD} , V _{OL} = 0 V			±1	μA

AC Characteristics (T_a = -40 to +85 °C, V_{DD} = 5 V ± 10 %)

Parameter	Symbol	Condition	MIN.	TYP.	MAX.	Unit
Operating Frequency	f _{IN1}	VCOL pin, MF mode, sine wave input : V _{IN} = 0.3 V _{p-p}	0.5		25	MHz
	f _{IN2}	VCOH pin, sine wave input : V _{IN} = 0.3 V _{p-p}	15		150	MHz
	f _{IN3}	AMIFC pin, sine wave input : V _{IN} = 0.3 V _{p-p}	0.1		1	MHz
	f _{IN4}	AMIFC pin, sine wave input : V _{IN} = 0.15 V _{p-p}	0.4		0.5	MHz
	f _{IN5}	FMIFC pin, sine wave input : V _{IN} = 0.3 V _{p-p}	5		13	MHz
	f _{IN6}	FMIFC pin, sine wave input : V _{IN} = 0.15 V _{p-p}	10		11	MHz

A/D Converter Characteristics (T_a = -40 to +85 °C, V_{DD} = 5 V ± 10%)

Parameter	Symbol	Condition	MIN.	TYP.	MAX.	Unit
A/D Conversion Resolution					8	bit
A/D Conversion Total Error		T _a = -10 to +50 °C		±1.5		LSB

10. PACKAGE DRAWING

80 PIN PLASTIC QFP (14×20)

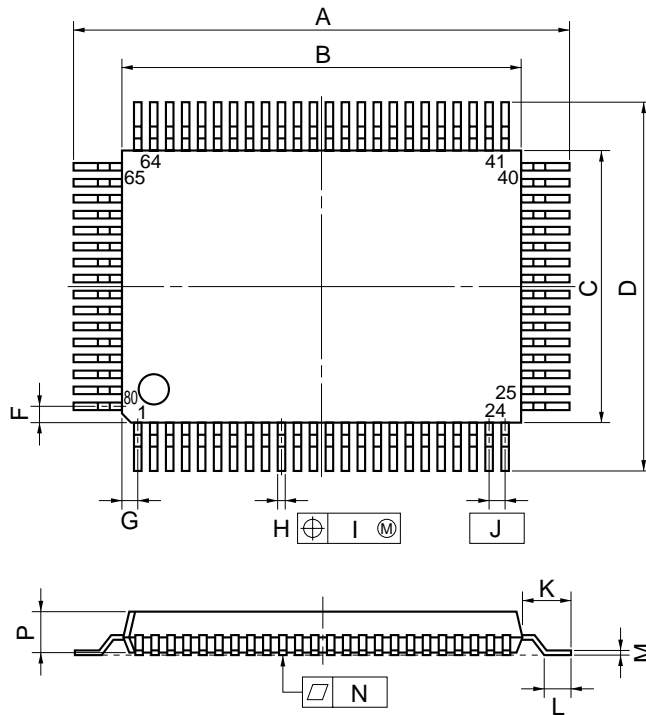

detail of lead end

NOTE

Each lead centerline is located within 0.15 mm (0.006 inch) of its true position (T.P.) at maximum material condition.

ITEM	MILLIMETERS	INCHES
A	23.2±0.2	0.913 ^{+0.009} _{-0.008}
B	20.0±0.2	0.787 ^{+0.009} _{-0.008}
C	14.0±0.2	0.551 ^{+0.009} _{-0.008}
D	17.2±0.2	0.677±0.008
F	1.0	0.039
G	1.8	0.031
H	0.35±0.10	0.014 ^{+0.004} _{-0.005}
I	0.15	0.006
J	0.8 (T.P.)	0.031 (T.P.)
K	1.6±0.2	0.063±0.008
L	0.8±0.2	0.031 ^{+0.009} _{-0.008}
M	0.15 ^{+0.10} _{-0.05}	0.006 ^{+0.004} _{-0.003}
N	0.12	0.005
P	2.7	0.106
Q	0.125±0.075	0.005±0.003
R	5°±5°	5°±5°
S	3.0 MAX.	0.119 MAX.

S80GF-80-3B9-2

NOTES FOR CMOS DEVICES

① PRECAUTION AGAINST ESD FOR SEMICONDUCTORS

Note: Strong electric field, when exposed to a MOS device, can cause destruction of the gate oxide and ultimately degrade the device operation. Steps must be taken to stop generation of static electricity as much as possible, and quickly dissipate it once, when it has occurred. Environmental control must be adequate. When it is dry, humidifier should be used. It is recommended to avoid using insulators that easily build static electricity. Semiconductor devices must be stored and transported in an anti-static container, static shielding bag or conductive material. All test and measurement tools including work bench and floor should be grounded. The operator should be grounded using wrist strap. Semiconductor devices must not be touched with bare hands. Similar precautions need to be taken for PW boards with semiconductor devices on it.

② HANDLING OF UNUSED INPUT PINS FOR CMOS

Note: No connection for CMOS device inputs can be cause of malfunction. If no connection is provided to the input pins, it is possible that an internal input level may be generated due to noise, etc., hence causing malfunction. CMOS device behave differently than Bipolar or NMOS devices. Input levels of CMOS devices must be fixed high or low by using a pull-up or pull-down circuitry. Each unused pin should be connected to V_{DD} or GND with a resistor, if it is considered to have a possibility of being an output pin. All handling related to the unused pins must be judged device by device and related specifications governing the devices.

③ STATUS BEFORE INITIALIZATION OF MOS DEVICES

Note: Power-on does not necessarily define initial status of MOS device. Production process of MOS does not define the initial operation status of the device. Immediately after the power source is turned ON, the devices with reset function have not yet been initialized. Hence, power-on does not guarantee out-pin levels, I/O settings or contents of registers. Device is not initialized until the reset signal is received. Reset operation must be executed immediately after power-on for devices having reset function.

[MEMO]

The application circuits and their parameters are for references only and are not intended for use in actual design-in's.

No part of this document may be copied or reproduced in any form or by any means without the prior written consent of NEC Corporation. NEC Corporation assumes no responsibility for any errors which may appear in this document.

NEC Corporation does not assume any liability for infringement of patents, copyrights or other intellectual property rights of third parties by or arising from use of a device described herein or any other liability arising from use of such device. No license, either express, implied or otherwise, is granted under any patents, copyrights or other intellectual property rights of NEC Corporation or others.

The devices listed in this document are not suitable for use in aerospace equipment, submarine cables, nuclear reactor control systems and life support systems. If customers intend to use NEC devices for above applications or they intend to use "Standard" quality grade NEC devices for applications not intended by NEC, please contact our sales people in advance.

Application examples recommended by NEC Corporation

Standard: Computer, Office equipment, Communication equipment, Test and Measurement equipment, Machine tools, Industrial robots, Audio and Visual equipment, Other consumer products, etc.

Special: Automotive and Transportation equipment, Traffic control systems, Antidisaster systems, Anticrime systems, etc.