

Read / Write amplifier for FDD

BH6625FS

The BH6625FS is a 4-mode read / write IC designed for floppy disk drives, and has an active filter that can be set according to transfer rate. Any of multiple write current settings can be selected, and inner track / outer track switching is done internally.

●Applications

Floppy disk drives (1MB, 1.6MB and 2MB)

●Features

- 1) Internal active filter with multiple settings that can be selected for multiple Q and f_0 .
- 2) Time domain filter that is internally switchable according to transfer rate.
- 3) Any of multiple write current settings can be selected, and inner track / outer track switching is done internally.

●Absolute maximum ratings (unless otherwise noted, $T_a = 25^\circ\text{C}$)

Parameter	Symbol	Limits	Unit
Power supply voltage	V_{CC}	+7	V
Operating temperature	T_{opr}	0~+70	$^\circ\text{C}$
Storage temperature	T_{stg}	-55~+125	$^\circ\text{C}$
Digital input voltage	V_I	-0.5~ $V_{CC}+0.3$	V
RW pin voltage	V_{RW}	+15	V
LVS output voltage	V_{LVS}	$V_{CC}+0.3$	V
ED pin voltage	V_{ER}	$V_{CC}+0.3$	V
Power dissipation	P_d	650*	mW

* Reduced by 6.5mW for each increase in T_a of 1°C over 25°C .

●Recommended operating conditions ($T_a = 25^\circ\text{C}$)

Parameter	Symbol	Min.	Typ.	Max.	Unit
Power supply voltage	V_{CC}	4.5	5.0	5.5	V

●Block diagram

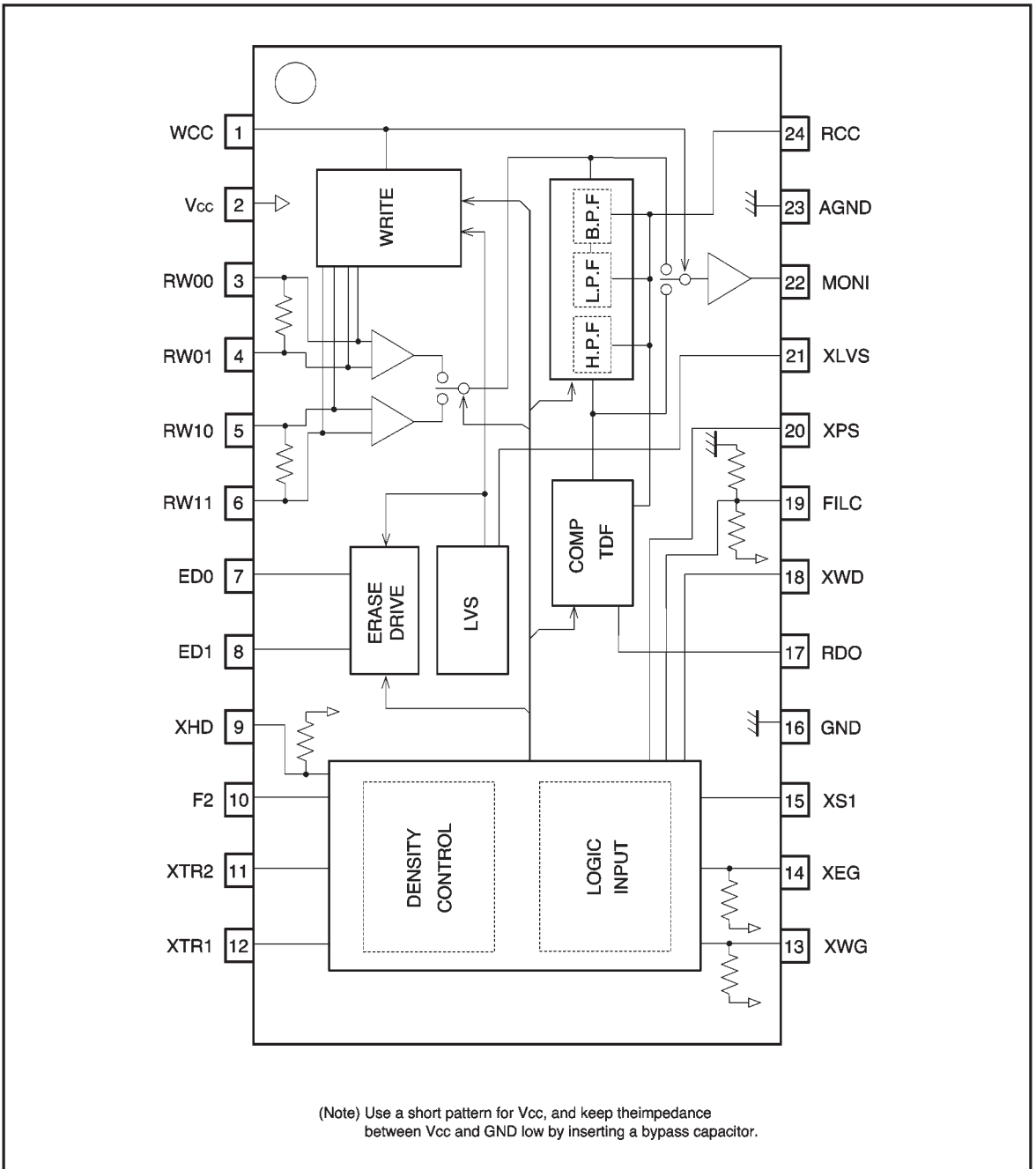

● Pin descriptions and input / output circuits

Pin No.	Pin name	Equivalent circuit	Function
1	WCC		<p>For connecting the write current adjustment resistor</p> <p>Connect the write current adjustment resistor between this pin and Vcc.</p> <p>Setting this pin to the low level during reading switches MONI to differentiator output.</p>
2	Vcc		Power supply pin
3	RW00		<p>Active when SIDE0 and the read/write head connecting pin (pin 15, XS1) is at the high level (side 0)</p> <p>Starts at RW00 during the start of writing (from reading to writing)</p>
4	RW01		<p>Active when the read/write head connecting pin (pin 15, XS1) is at the low level (side 1)</p> <p>Starts at RW10 during the start of writing (from reading to writing)</p>
5	RW10		
6	RW11		
7	ED0		Side 0 erase current sink
8	ED1		Side 1 erase current sink

Pin No.	Pin name	Equivalent circuit	Function
9	XHD		<p>1MB/2MB selector High = 1MB Low = 2MB</p>
10	F2		<p>1.6MB drive selector Selector signal high level = active High = 1.6MB drive, low = 2MB drive</p>
11	XTR2		<p>Inner track/outer track position setting Controls the write current</p>
12	XTR1 (XSWF)		<p>Inner track/outer track position setting Controls the filter and write current</p>
13	XWG		<p>Write enable gate (Schmidt input) Low = active</p>
14	XEG		<p>Erase enable gate (Schmidt input) Low = active</p>
15	XS1		<p>Head/side switching signal Low = active (Schmidt input) High = side 0, low = side 1</p>

Pin No.	Pin name	Equivalent circuit	Function
16	DGND		Digital ground
17	RDO		Read data output TTL high level = active
18	XWD		Write data input Operates at falling edge (Schmitt input)
19	FILC		Filter control (f_0, Q) Used to switch filter cutoff frequency (tri-state input)
20	XPS		Power save selector Low = active

Pin No.	Pin name	Equivalent circuit	Function
21	XLVS		<p>External low level voltage detection pin</p> <p>Open collector output when low level voltage is detected</p> <p>Switches to low level when Vcc drops below the specified voltage</p>
22	MONI		<p>Preamplifier output and differentiator output monitoring</p> <p>Monitor is switched with pin 1 (WCC)</p>
23	AGND		<p>Analog ground</p>
24	RCC		<p>Filter (LPF, BPF) cutoff frequency and TDF 1st M/M pulse width setting resistor connection</p>

●Electrical characteristics (unless otherwise noted, Ta = 25°C, Vcc = 5V)

Supply current

Parameter	Symbol	Min.	Typ.	Max.	Unit	Conditions
Current dissipation, Standby	ICCST	—	245	400	μA	*1
Current dissipation, Read	ICCR	—	28	42	mA	*1
Current dissipation, Write	ICCW	—	8.5	15	mA	*2

*1 RRCC=2.0 [kΩ] (XHD=H)

*2 RWCC=2.4 [kΩ] (When 2MB inner edge, XTR2=high level, excluding IWR and IER)

Low level voltage detection circuit

Parameter	Symbol	Min.	Typ.	Max.	Unit	Conditions
Threshold voltage 1	VTH1+	—	4.05	4.30	V	When power supply voltage rises, internal LVS/write protect
	VTH1—	3.60	3.85	4.10	V	When power supply voltage falls, internal LVS/write protect
Threshold voltage 2	VTH2+	—	3.95	4.20	V	When power supply voltage rises, external LVS
	VTH2—	3.50	3.75	4.00	V	When power supply voltage falls, external LVS
Hysteresis voltage	VH	50	—	—	mV	
Output low level voltage	VOL	—	—	0.40	V	Vcc=2.5 [V] IOL=0.2 [mA]
Output leakage current	IOH	—	—	10	μA	

Recovery time

Parameter	Symbol	Min.	Typ.	Max.	Unit	Conditions
POWER · SAVE→READ	TR2	—	—	500	μs	by XPS
READ→ERASE	TR3	—	—	6	μs	by XEG
READ→WRITE	TR4	—	—	4	μs	by XWG
WRITE→READ	TR5E	—	—	20	μs	by XEG
	TR5W	—	—	160	μs	by XWG
SIDE0↔SIDE1	TR6	—	—	40	μs	by XS1
1MB↔2MB	TR7	—	—	40	μs	by XHD

Preamplifier

Parameter	Symbol	Min.	Typ.	Max.	Unit	Conditions
Voltage gain (1)	GVD1	43	46	49	dB	f=125[kHz], VIN=2.5[mV _{P-P}] (XTR1=L) (differential)
Voltage gain (2)	GVD2	46	49	52	dB	f=125[kHz], VIN=2.5[mV _{P-P}] (XTR1=H) (differential)
SIDE0 ↔ SIDE1 crosstalk	GCTLK	50	—	—	dB	f=125[kHz], VIN=100[mV _{P-P}] (differential)*3
Differential input resistance	RID	—	3.3	—	kΩ	8.0 [kΩ] input resistance, //5.5 [kΩ] damping resistance
Input conversion noise voltage	VN	—	2.5	3.7	μV _{rms}	f=500[Hz] ~ 1[MHz]
Input sink current	ISINK	—	180	—	μA	
Differential input voltage amplitude tolerance (1)	VIN1	—	—	5.0	mV _{P-P}	5% distortion (sine wave input) (XTR1=L)
Differential input voltage amplitude tolerance (2)	VIN2	—	—	3.5	mV _{P-P}	5% distortion (sine wave input) (XTR1=H)
Common mode rejection ratio	CMRR	50	—	—	dB	f=125[kHz], VIN=100[mV _{P-P}] *3
Power supply rejection ratio	PSRR	40	—	—	dB	f=250[kHz], VIN=100[mV _{P-P}] *3

Preamplifier / L.P.F / differentiator (B.P.F)

Parameter	Symbol	Min.	Typ.	Max.	Unit	Conditions
Filter time constant accuracy	EFIL	-10	—	+10	%	*3
Total gain (preamplifier/ LPF/differentiator) (1)	GVDD1	40.5	44.5	48.5	dB	f=250[kHz], VIN=2.5[mV _{P-P}] (differential) (2MB, XTR1=L, FILC=H)
Total gain (preamplifier/ LPF/differentiator) (2)	GVDD2	43.5	47.5	51.5	dB	f=250[kHz], VIN=2.5[mV _{P-P}] (differential) (2MB, XTR1=H, FILC=H)
Differentiator output peaking frequency setting range	f _o	0.1	—	0.5	MHz	Defined according to typical value in the settings

*3 RRCC=2.0 [kΩ] (XHD=L, XTR1=H, F2=L, FILC=H)

Comparator and waveform shaping

Parameter	Symbol	Min.	Typ.	Max.	Unit	Conditions
TDF M/M pulse width accuracy (1)	TDF1	-10	—	+10	%	XHD=H, F2=L (Typ. : 2470[ns]) f=62.5[kHz] ~ 125[kHz] *4
TDF M/M pulse width accuracy (2)	TDF2	-10	—	+10	%	XHD=H, F2=H (Typ. : 2040[ns]) f=62.5[kHz] ~ 125[kHz] *4
TDF M/M pulse width accuracy (3)	TDF3	-10	—	+10	%	XHD=L, F2=H / L (Typ. : 1230[ns]) f=125[kHz] ~ 250[kHz] *4
RD pulse width	TRD	270	400	530	ns	Judgment level 1.5 [V]
Rise time	TTLH	—	—	70	ns	Rise time till 0.4 [V] - 2.0 [V]
Fall time	TTHL	—	—	70	ns	Fall time till 2.0 [V] - 0.4 [V]
Peak shif	P. S.	—	—	1.0	%	f=250[kHz], VIN=1[mV _{P-P}] (differential)
Output low level voltage	VOL	—	—	0.5	V	
Output high level voltage	VOH	2.7	—	—	V	Rise level at 0.4 [V] to 70 [ns]

*4 RRCC=2.0 [kΩ]

Write circuit

Parameter	Symbol	Min.	Typ.	Max.	Unit	Conditions
Write current adjustment range	IWR	2.0	—	20	mA0-P	
Write current accuracy	ACIW	-7.0	—	+7.0	%	*5
Write current pairability	Δ IWR	-1.0	—	+1.0	%	RWCC=2.4[k Ω]
Write current supply voltage dependency	PSIW	-4.0	-0.8	+3.0	% / V	RWCC=2.4[k Ω]
Output saturation voltage	VSATRW	—	0.4	1.0	V	IWR=12[mA]
Off-state leakage current	ILKRW1	—	—	20	μ A	Unselected side
	ILKRW2	—	—	50	μ A	Selected side
Minimum write data pulse width	TWD	70	—	—	ns	
Write current inner track/ outer track ratio accuracy	ACIWTR	$\pm 10 \times (1 - \text{setting ratio})$			%	*6

*5 RWCC=2.4 [k Ω] , adapted for desired setting of XTR1, XTR2

*6 Error in setting ratio (reference: XTR1=L, XTR2=L)

Erase output

Parameter	Symbol	Min.	Typ.	Max.	Unit	Conditions
Erase current adjustment	IER	—	—	40	mA	
Output saturation voltage	VSATER	—	0.2	0.6	V	IER=40[mA]
Output leakage current	IOH	—	—	10	μ A	OFF, ED0=ED1=V _{cc}

Logic input

Parameter	Symbol	Min.	Typ.	Max.	Unit	Conditions
Input high level voltage	VIH	2.0	—	—	V	Excluding FILC
Input low level voltage	VIL	—	—	0.8	V	Excluding FILC
Input voltage hysteresis	VH	0.15	—	—	V	Applies to XWD, XWG, XEG, XS1
Input low level current	IIL1	—	50	100	μ A	V _{cc} =5[V] VIL=GND Applies to XWG, XEG, XHD
Tri-state interface	VIH	4.2	—	—	V	Applies to FILC
	VIM	2.0	2.5	3.0	V	Applies to FILC
	VIL	—	—	0.8	V	Applies to FILC
	IIH	—	50	100	μ A	V _{cc} = [V], VIH=5[V], applies to FILC
	IIL	—	50	100	μ A	V _{cc} =5[V], VIL=0[V], applies to FILC

● Read characteristics

Density			1MB				1.6MB		2MB		
Transfer rate		FILC	250[kbps]		300[kbps]		500[kbps]		500[kbps]		
Input	Mode	XHD	NO CARE		HIGH		HIGH		LOW		
		F2	NO CARE		LOW		HIGH		HIGH		
Input	Track	XTR1 (XSWF)	NO CARE	Outer track	Inner track	Outer track	Inner track	Outer track	Inner track	Outer track	Inner track
				LOW	HIGH	LOW	HIGH	LOW	HIGH	LOW	HIGH
Output	Filter	fo [kHz] Characteristic *1	HIGH	144	162	171	192	324	422	384	358 (C)
			OPEN	167	182	201	216	309	400	336	361 (B)
			LOW	139	162	165	192	301	384	350	361 (B)
	TDF	[nSEC]	NO CARE	2470		2040		1230		1230	

*1 (B) Chebyshev characteristics.

(However RRCC=2.0 [kΩ])

(C) All are Butterworth characteristics except 2MB inner edges. High-ripple Chebyshev characteristics.

Total filter peak frequency setting

$$f_0 = a / (RRCC [k\Omega] + 0.09) [kHz]$$

FILC	"H"	"OPEN"	"L"	
a =	300	353	290	250 [kbps] outer track
	339	380	339	250 [kbps] inner track
	357	420	345	300 [kbps] outer track
	401	451	401	300 [kbps] inner track
	677	646	629	500 [kbps] outer track (when F2 = H)
	882	836	732	500 [kbps] inner track (when F2 = H)
	803	702	732	500 [kbps] outer track (when F2 = L)
	748	754	←	500 [kbps] inner track (when F2 = L)

TDF time constant setting

$$250 [kbps] : T = 940 \times RRCC [k\Omega] + 590 [ns]$$

$$300 [kbps] : T = 745 \times RRCC [k\Omega] + 550 [ns]$$

$$500 [kbps] : T = 377 \times RRCC [k\Omega] + 476 [ns]$$

● Write current switching ratio

Track		Outer edge ← → Inner edge			
Density	XTR1	L		H	
	XTR2	L	H	L	H
2MB		0.450	0.400	0.350	0.300
1.6MB		0.500	0.450	0.400	0.350
1MB (250kbps)		0.933	0.833	0.766	0.677
1MB (300kbps)		1.000	0.900	0.800	0.700

Write current setting

$$I_{wr} = \frac{24.0}{RWCC [k\Omega]} [mA]$$

● Filter characteristic

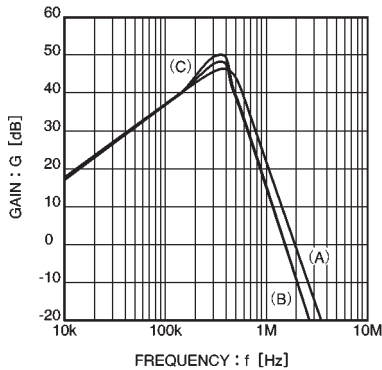
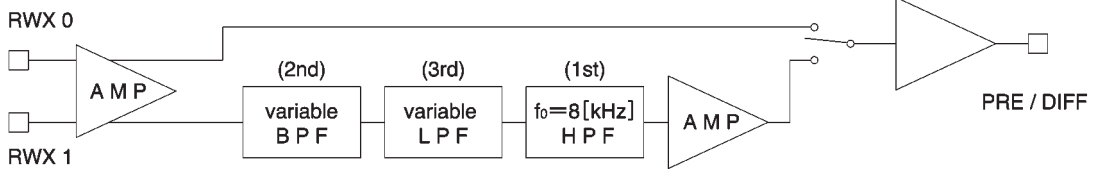
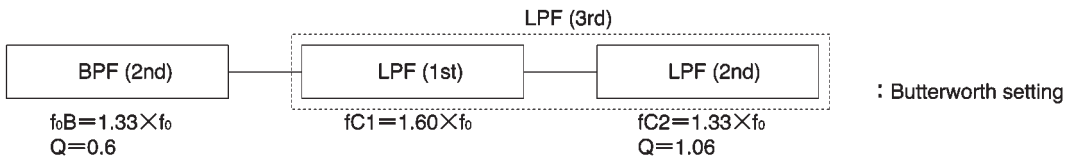

Fig. 1 PRE IN - DIFF OUT

Preamplifier-differentiator (B.P.F)-L.P.F



(A) Total characteristic peak frequency (f_0): 1M, 1.6M, 2M [outer edge]



(B) Total characteristic peak frequency (f_0) when FILC = low level or FILC = open, 2M [inner edge]

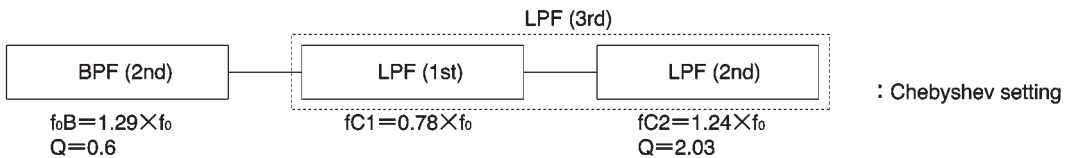

(C) Total characteristic peak frequency (f_0) when FILC = high level, 2M [inner edge]

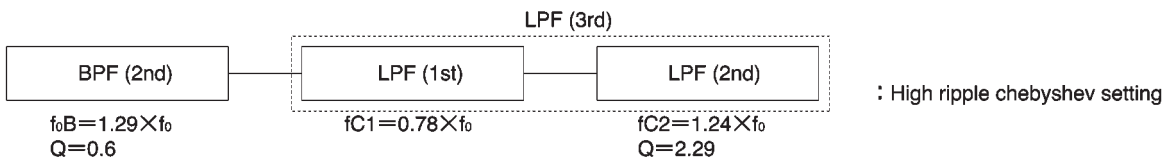

● Measurement circuit

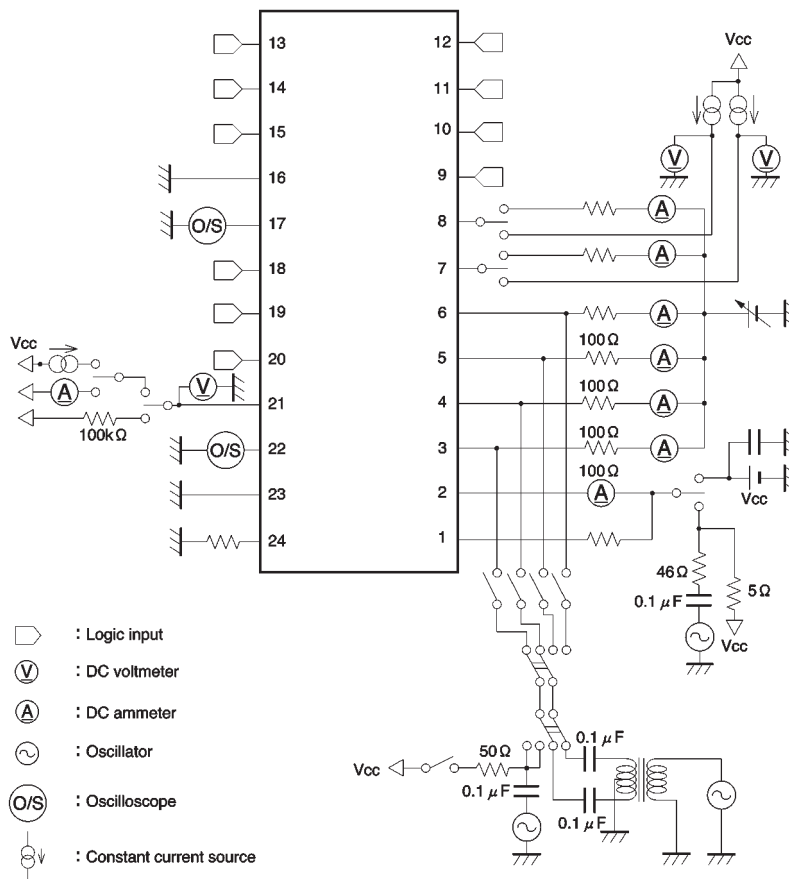

Fig. 2

● Circuit operation

(1) Read

The input signal from the head coils from each side of the disc is amplified by the preamplifier and then differentiated. The filter time constant can be set externally. After differentiation, the differential output is input to the comparator. The time domain filter detects zero cross, and the output is converted to read data. The monostable multivibrator width can be set externally, while the read data pulse width is a constant 400ns.

(2) Write

Input write data are converted to toggle movements by the internal flip-flops, operating the write driver. The write driver current is supplied by the write current generator,

but the externally set current can be controlled according to density and by selecting inner track / outer track.

(3) Erase

An open collector output pin is used, and the erase current is set with a resistor between it and the head.

(4) Power supply

When the low level voltage detector detects a drop in the supply voltage, writing and erasing are prohibited.

● Operation notes

- (1) Use a short pattern for V_{CC} , and a sufficiently wide AGND and DGND. Keep the impedance between V_{CC} and GND low by inserting a bypass capacitor.
- (2) Use a pattern that will minimize interference between digital signals and the head.

● Electrical characteristic curves

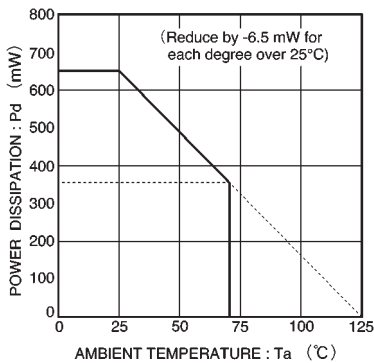

Fig. 3 Thermal derating characteristics

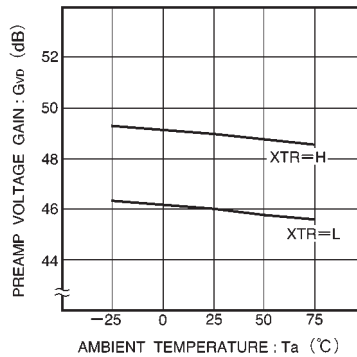

Fig. 4 Preamp voltage gain vs. ambient temperature

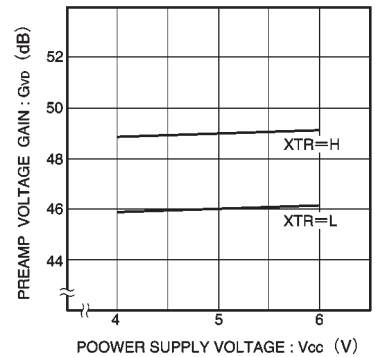

Fig. 5 Preamp voltage gain vs. power supply voltage

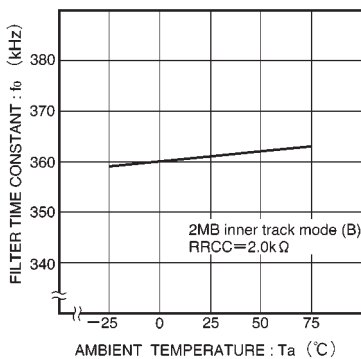

Fig. 6 Filter time constant (f_0) vs. ambient temperature

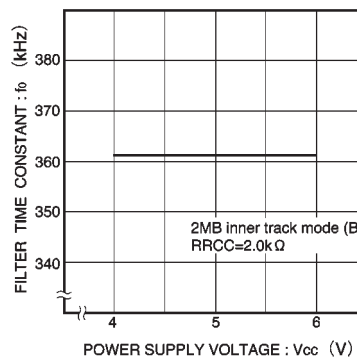

Fig. 7 Filter time constant (f_0) vs. power supply voltage

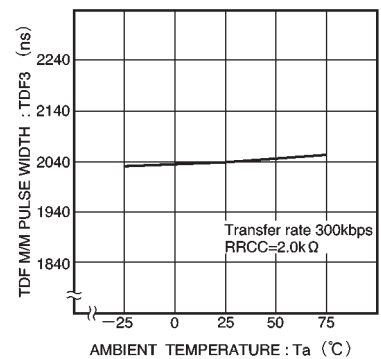

Fig. 8 TDF time constant vs. ambient temperature

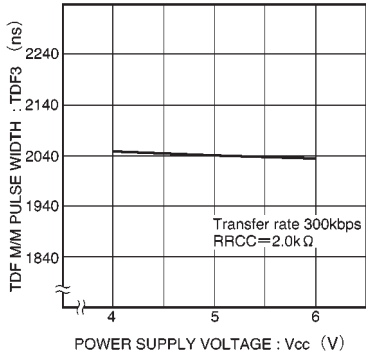

Fig. 9 TDF time constant vs. power supply voltage

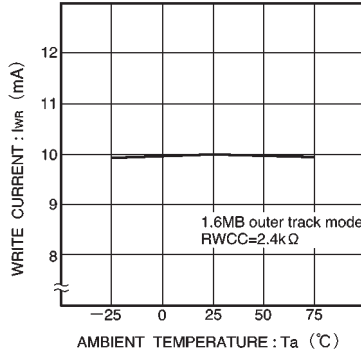

Fig. 10 Write current vs. ambient temperature

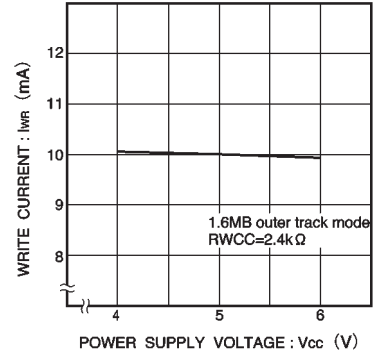

Fig. 11 Write current vs. power supply voltage

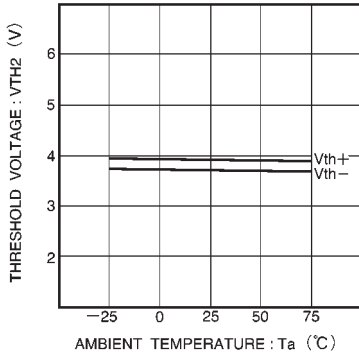

Fig. 12 Low level detection voltage vs. ambient temperature

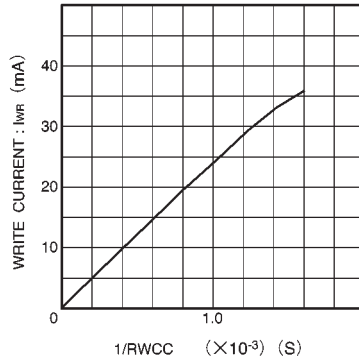

Fig. 13 Write current vs. write current adjustment resistance

● External dimensions (Units: mm)

