



ONE KEY MULTI-SECTION  
7 SEC VOICE

7 秒 語 音 IC

VOICE	
M5207	

**FEATURES 功能敘述**

- IO1 : D/A, BusyH, BusyL, StopH, StopL, 3 Hz, 6 Hz, dynamic.
- IO2 : PWM1, BusyH, BusyL, StopH, StopL, 3 Hz, 6 Hz, dynamic.
- IO3 : PWM2, BusyH, BusyL, StopH, StopL, 3 Hz, 6 Hz, dynamic.
- Up to 16 voice section.
- 112 voice steps table up to 16 sub-table of steps.
- Direct driver speaker or buzzer.
- External or Built-in resistor.
- TG : SEQUENTIAL/RANDOM TRIGGER, EDGE/LH, RETRIG/IRRETRIG, HOLD/UNHOLD.
- Debounce time : 10ms/50  $\mu$ s
- Voice + Mute length MAX. 22 sec ( S.R=6KHz )

**APPLICATION 產品應用**

- Toy s, Clock, Pager, Game etc..

**ELECTRICAL CHARACTERISTICS 電氣規格**

( @V<sub>DD</sub>=3V unless otherwise specified )

Characteristics	Sym.	Min.	Typ.	Max.	Unit	REMARKS
工作電壓 Operating Voltage	V <sub>DD</sub>	2.4	3	5.0	V	
工作電流 Operating Current	I <sub>OP</sub>	—	0.2	1	mA	No load
靜態電流 Quiescent Current	I <sub>SB</sub>	—	1	5	$\mu$ A	
推動電流 AUD Driving Current	I <sub>O</sub>	—	-3	—	mA	@ Vout=0.7V, Full Scale
推動電流 LO Driving Current	I <sub>OH</sub>	1	—	—	mA	@ Vout=2V
	I <sub>OL</sub>	3	—	—		@ Vout=1.0V
振盪頻率 Oscillator Frequency	F <sub>OSC</sub>	—	768	—	KHz	External $\pm$ 30%, Rosc=K $\Omega$
工作溫度 Operating Temperature	Temp.	-10	25	60	$^{\circ}$ C	

**APPLICATION DIAGRAM 參考電路圖**

(A) IO1-LED IO2:PWM1 IO2:PWM2

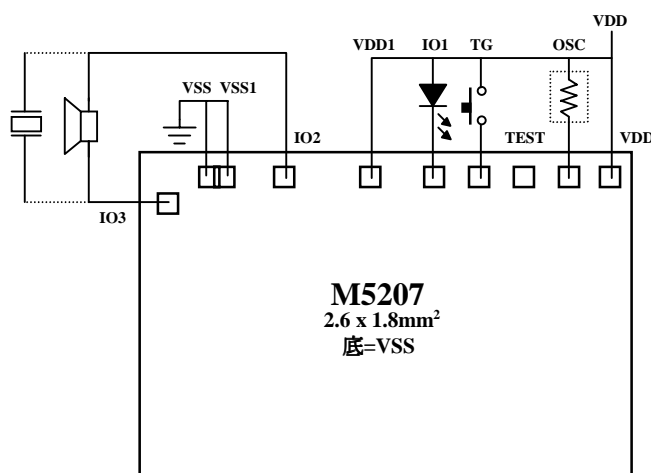

\*All specs and applications shown above subject to change without prior notice.

( 以上電路及規格僅供參考,本公司得逕行修正 )



一 華 半 導 體 股 份 有 限 公 司  
MOSDESIGN SEMICONDUCTOR CORP.

“TENTATIVE”

TAIPEI: TEL: 886-2- 22783733

FAX: 886-2- 22783633

H.K. : TEL: 852- 27569109

FAX: 852- 27566961

ONE KEY MULTI-SECTION  
7 SEC VOICE

7 秒 語 音 IC

VOICE	
M5207	

APPLICATION DIAGRAM 參考電路圖 (CONTINUED)

(B) IO1-D/A IO2:PWM1 IO2:PWM2

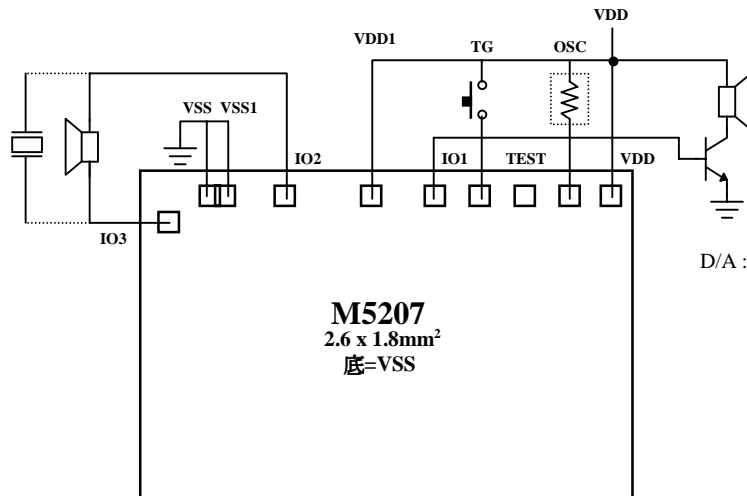

D/A : 3 current output level  
(1.5mA, 3mA, 4.5mA)  
By mask option

\*All specs and applications shown above subject to change without prior notice.  
( 以上電路及規格僅供參考,本公司得逕行修正 )



ONE KEY MULTI-SECTION  
7 SEC VOICE

7 秒語音 IC

VOICE	
M5207	

**SEQUENTIAL TRIGGER:**

• EDGE/UNHOLD

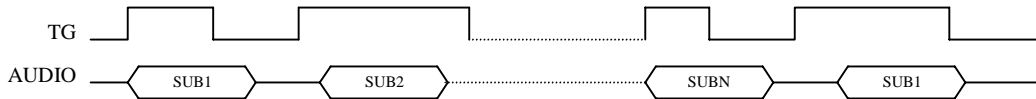

• LH/UNHOLD

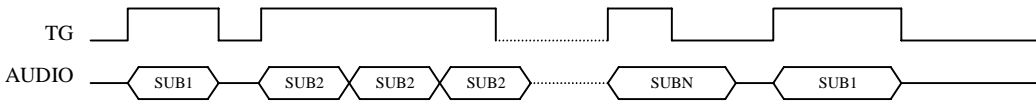

• EDGE/HOLD

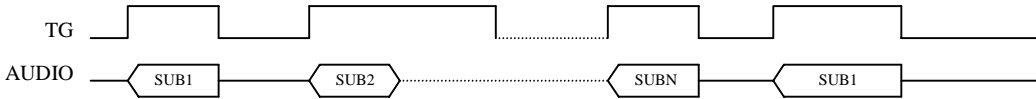

• LH/HOLD

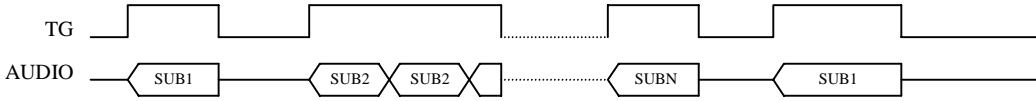

• RETRIG

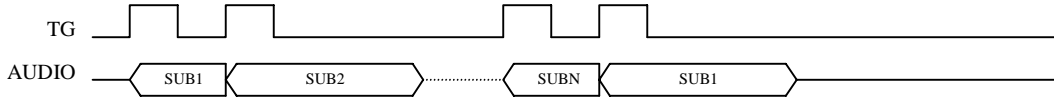

• IRRETRIG

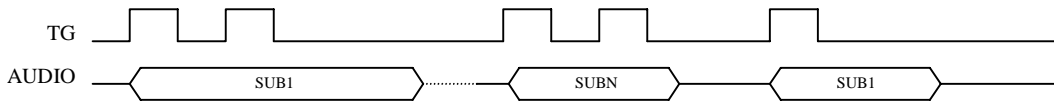



ONE KEY MULTI-SECTION  
7 SEC VOICE

7 秒語音 IC

VOICE	
M5207	

**RANDOM TRIGGER:**

• EDGE/UNHOLD

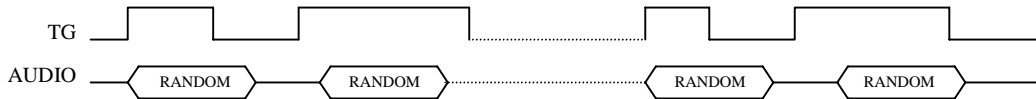

• LH/UNHOLD

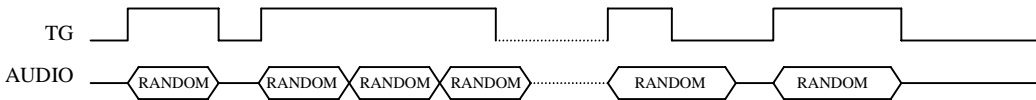

• EDGE/HOLD

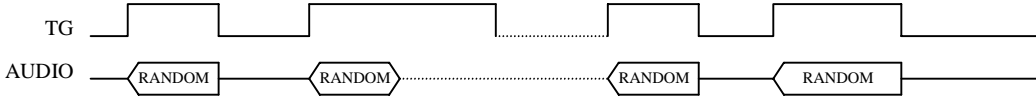

• LH/HOLD

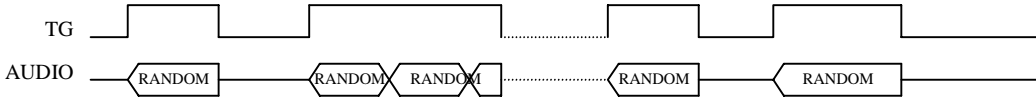

• RETRIG

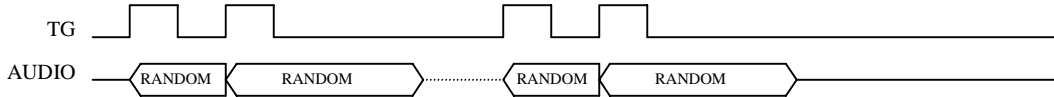

• IRRETRIG

