

2-INPUT 3CHANNEL VIDEO SWITCH

■ GENERAL DESCRIPTION

NJM2284 is a switching IC for switching over from one audio or video input signal to another. Internalizing 2 inputs, 1 output, and then each set of 3 can be operated independently. One of them is a "Clamp type" and it can be operated while DC level fixed in position of the video signal. It is a higher efficiency video switch, featuring the operating supply voltage 4.75 to 13.0V, the frequency feature 10MHz, and then the Crosstalk 75dB (at 4.43MHz).

■ PACKAGE OUTLINE

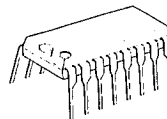

NJM2284D

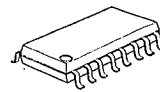

NJM2284M



NJM2284V

■ FEATURES

- 2 Input-1 Output Internalizing 3 Circuits (one of them is a Clamp type).
- Wide Operating Voltage
- Crosstalk 75dB(at 4.43MHz)
- Wide Bandwidth Frequency Feature 10MHz(2V_{r-p} Input)
- Package Outline DIP-16, DMP-16, SSOP-16

■ RECOMMENDED OPERATING CONDITION

- Supply Voltage V⁺ 4.75~13.0V

■ APPLICATIONS

- VCR, Video Camera, AV-TV, Video Disk Player.

■ BLOCK DIAGRAM

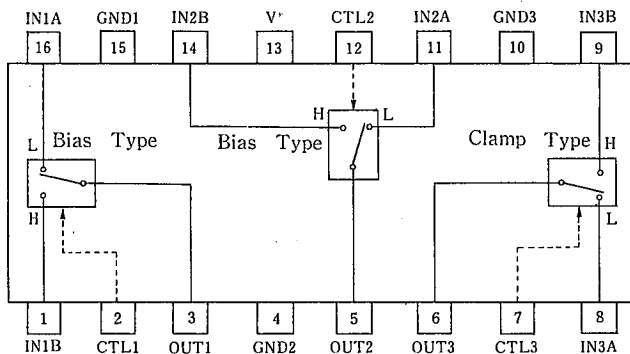

NJM2284D
NJM2284M
NJM2284V

5

■ MAXIMUM RATINGS

(Ta=25°C)

PARAMETER	SYMBOL	RATINGS	UNIT
Supply Voltage	V*	14	V
Power Dissipation	Pd	(DIP16) 700	mW
		(DMP16) 350	mW
		(SSOP16) 300	mW
Operating Temperature Range	T _{opr}	-40~+85	°C
Storage Temperature Range	T _{stg}	-40~+125	°C

■ ELECTRICAL CHARACTERISTICS

(V*=5V, Ta=25°C)

PARAMETER	SYMBOL	TEST CONDITION	MIN.	TYP.	MAX.	UNIT
Operating Current (1)	I _{CC1}	V*=5V (Note1)	8.1	11.6	15.1	mA
Operating Current (2)	I _{CC2}	V*=9V (Note1)	10.2	14.6	19.0	mA
Voltage Gain	G _V	V _I = 100kHz, 2V _{P-P} , V _O /V _I	-0.6	-0.1	+0.4	dB
Frequency Gain	G _F	V _I = 2V _{P-P} , V _O (10MHz)/V _O (100kHz)	-1.0	0	+1.0	dB
Differential Gain	DG	V _I = 2V _{P-P} , Standard Staircase Signal	—	0.3	—	%
Differential Phasa	DP	V _I = 2V _{P-P} , Standard Staircase Signal	—	0.3	—	deg
Output Offset Voltage	V _{OS}	(Note2)	-10	0	+10	mV
Crosstalk	CT	V _I = 2V _{P-P} , 4.43MHz, V _O /V _I	—	-75	—	dB
Switch Change Over Voltage	V _{CH}	All inside Switch ON	2.5	—	—	V
Switch Change Over Voltage	V _{CL}	All inside Switch OFF	—	—	1.0	V

(Note1) S1=S2=S3=S4=S5=S6=S7=1

(Note2) S1=S2=S3=S4=S5=S6=1, S7=1→2 Measure the output DC voltage difference

■ TERMINAL EXPLANATION

PIN No.	PIN NAME	VOLTAGE	INSIDE EQUIVALENT CIRCUIT
16 1 11 14	IN 1 A IN 1 B IN 2 A IN 2 B (Input)	2.5V	
8 9	IN 3 A IN 3 B (Input)	1.5V	
2 12 7	CTL 1 CTL 2 CTL 3 (Switching)		
3 5	OUT 1 OUT 2	1.8V	
6	OUT 3 (Output)	0.8V	
13	V+	5V	
15 4 10	GND 1 GND 2 GND 3		

5

■ TEST CIRCUIT

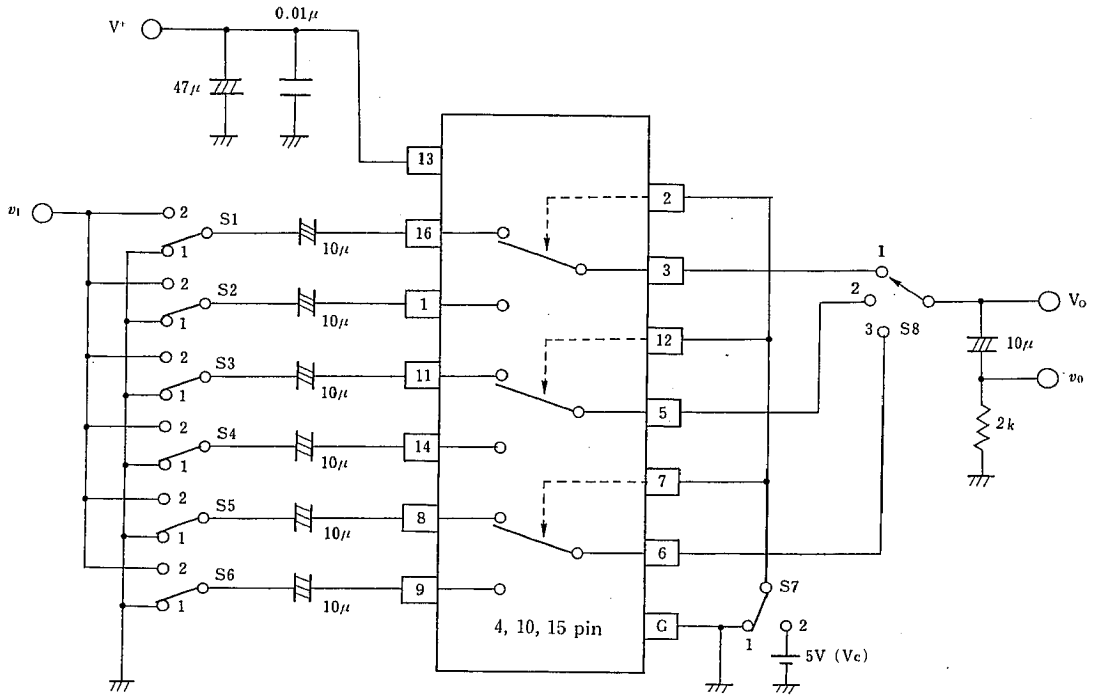

This IC requires $1M\Omega$ resistance between INPUT and GND pin for clamp type input since the minute current causes an unstable pin voltage.

Parameter	S 1	S 2	S 3	S 4	S 5	S 6	S 7	S 8	Test Part
Icc1	1	1	1	1	1	1	1	1	V ⁺
Icc2	1	1	1	1	1	1	1	1	
Gv1	2	1	1	1	1	1	1	1	v ₀
Gf1	2	1	1	1	1	1	1	1	
DG ₁	2	1	1	1	1	1	1	1	
DP ₁	2	1	1	1	1	1	1	1	
CT1	2	1	1	1	1	1	2	1	v ₀
CT2	1	2	1	1	1	1	1	1	
CT3	1	1	2	1	1	1	2	2	
CT4	1	1	1	2	1	1	1	2	
CT5	1	1	1	1	2	1	2	3	
CT6	1	1	1	1	1	2	1	3	
Vos1	1	1	1	1	1	1	1/2	1	V ₀
Vc1	1/2	2/1	1	1	1	1	V _c	1	V _c
THD	2	1	1	1	1	1	1	1	v ₀

■ TYPICAL CHARACTERISTICS

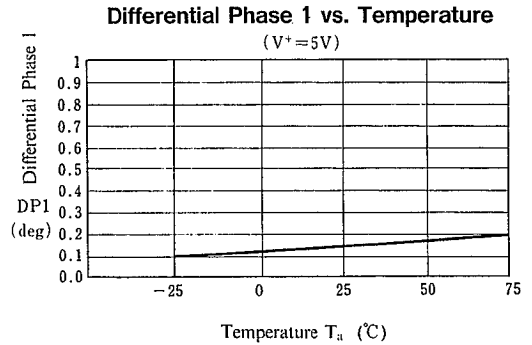
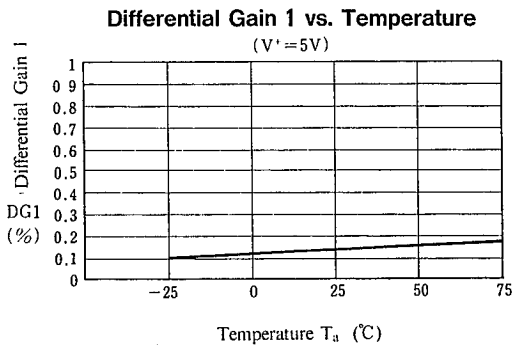
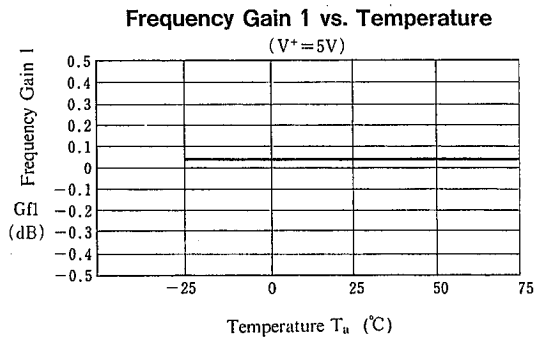
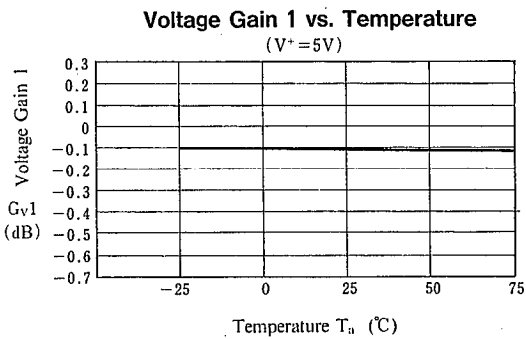
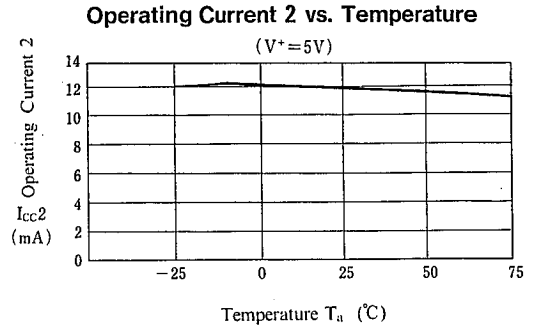
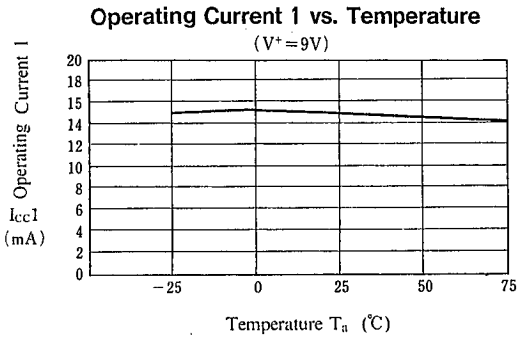

5

TYPICAL CHARACTERISTICS

Offset Voltage 1 vs. Temperature
($V^+ = 5V$)

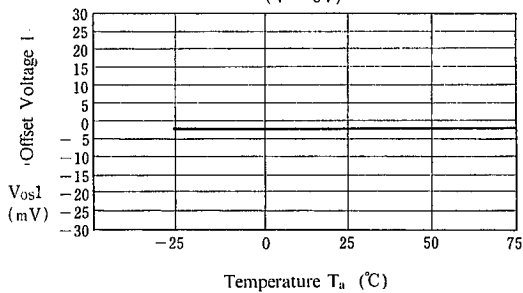

Crosstalk 1 vs. Temperature
($V^+ = 5V$)

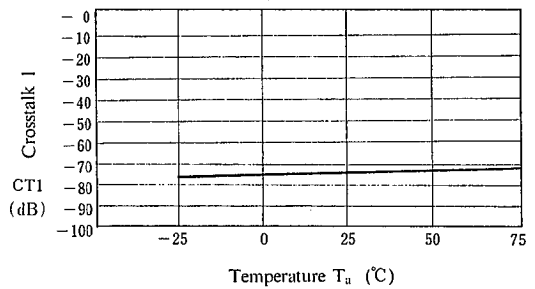

Crosstalk 2 vs. Temperature
($V^+ = 5V$)

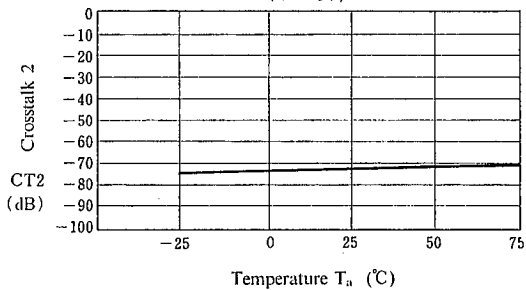

Crosstalk 3 vs. Temperature
($V^+ = 5V$)

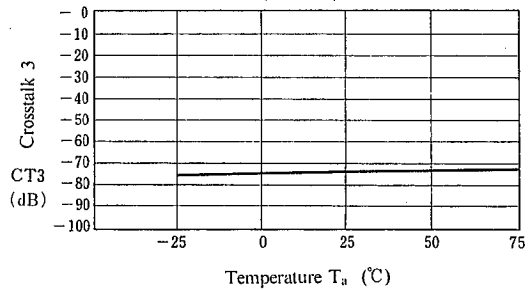

Crosstalk 4 vs. Temperature
($V^+ = 5V$)

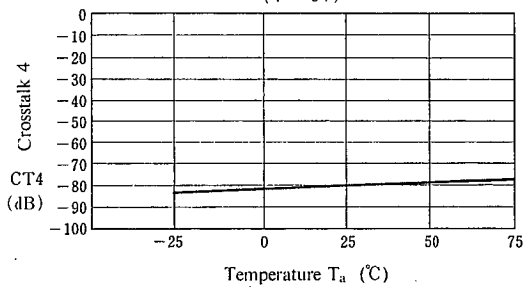

Crosstalk 5 vs. Temperature
($V^+ = 5V$)

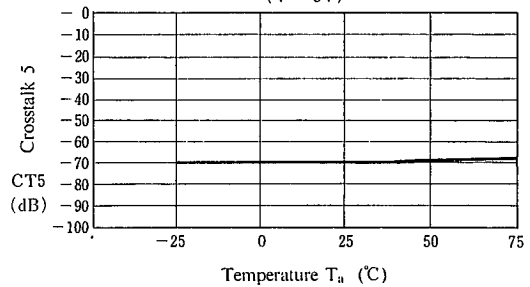

■ TYPICAL CHARACTERISTICS

Crosstalk 6 vs. Temperature

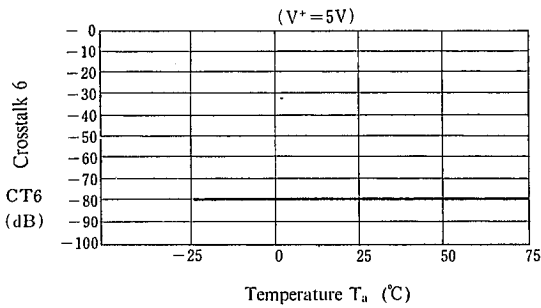

Switch Change Over 1 vs. Temperature

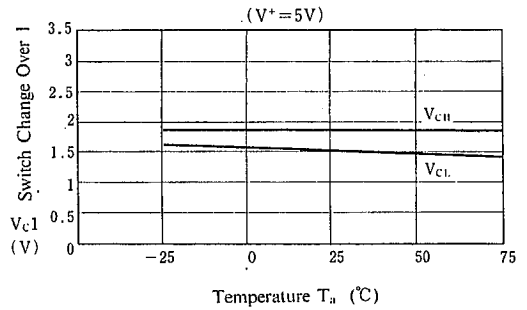

Operating Current vs. Operating Voltage

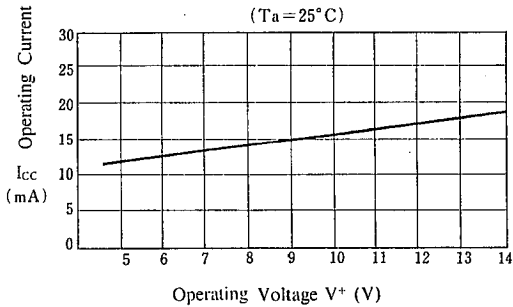

Voltage Gain 1 vs. Operating Voltage

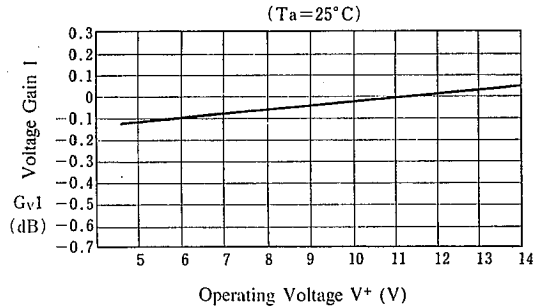

Frequency Gain 1 vs. Operating Voltage

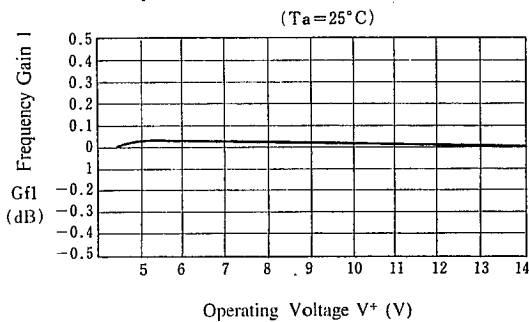

Differential Gain 1 vs. Operating Voltage

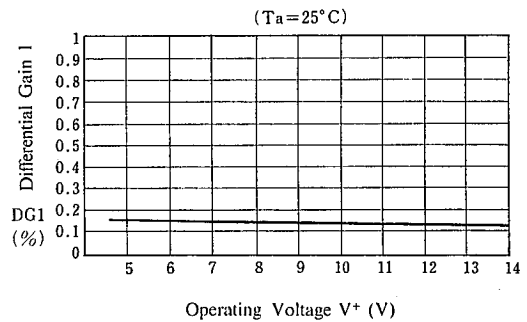

TYPICAL CHARACTERISTICS

Differential Phase 1 vs. Operating Voltage

(Ta=25°C)

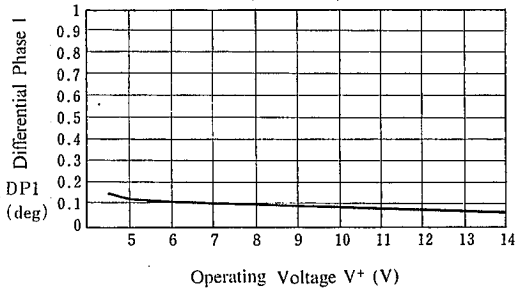

Offset Voltage 1 vs. Operating Voltage

(Ta=25°C)

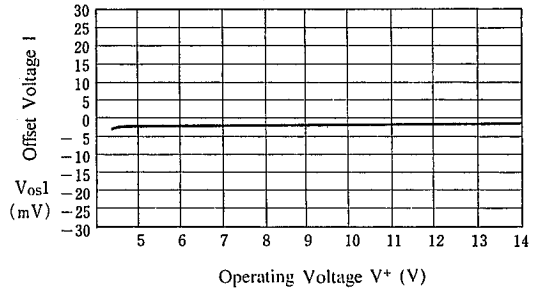

Crosstalk 1 vs. Operating Voltage

(Ta=25°C)

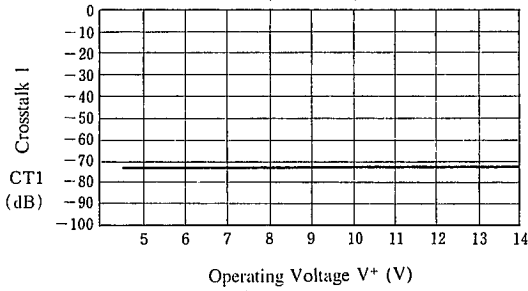

Crosstalk 2 vs. Operating Voltage

(Ta=25°C)

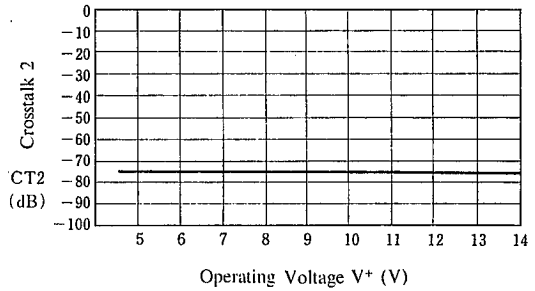

Crosstalk 3 vs. Operating Voltage

(Ta=25°C)

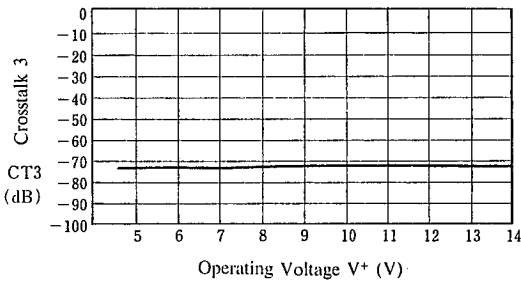

Crosstalk 4 vs. Operating Voltage

(Ta=25°C)

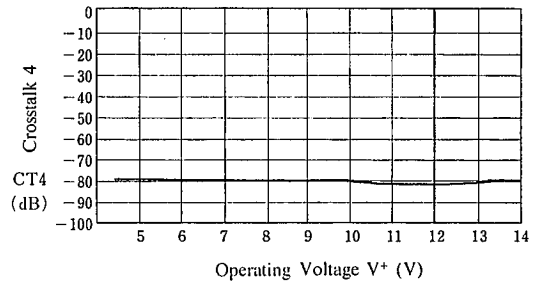

■ TYPICAL CHARACTERISTICS

Crosstalk 5 vs. Operating Voltage
($T_a = 25^\circ\text{C}$)

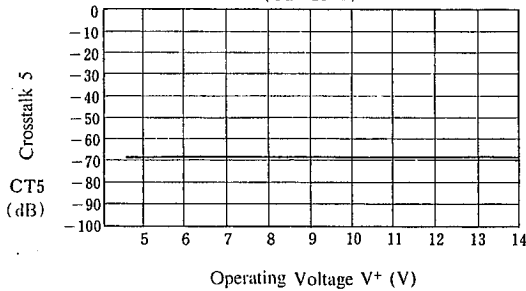

Crosstalk 6 vs. Operating Voltage
($T_a = 25^\circ\text{C}$)

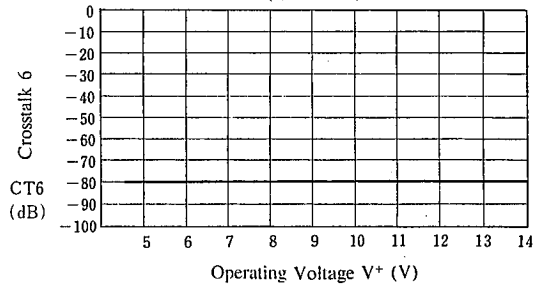

Switch Change Over 1 vs. Operating Voltage
($T_a = 25^\circ\text{C}$)

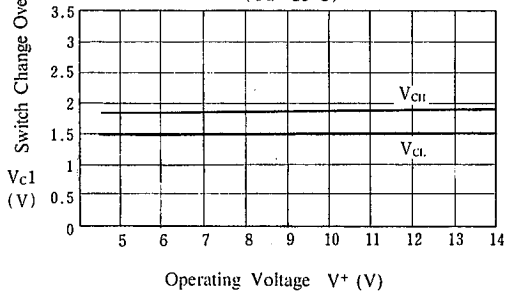

Differential Gain vs. APL
($T_a = 25^\circ\text{C}$)

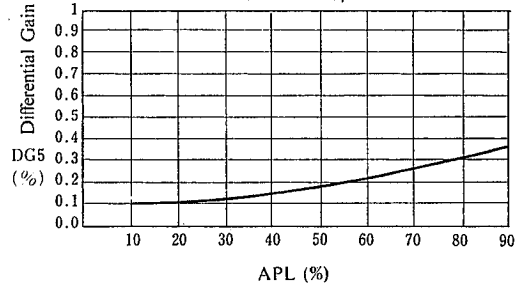

Voltage Gain 1 vs. Frequency Feature
($T_a = 25^\circ\text{C}$)

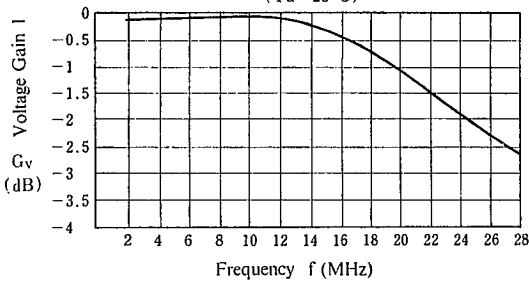

Differential Gain 1 vs. Load Resistor
($T_a = 25^\circ\text{C}$)

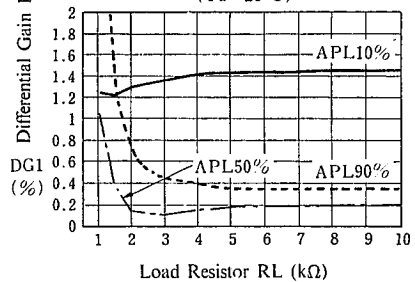

TYPICAL CHARACTERISTICS

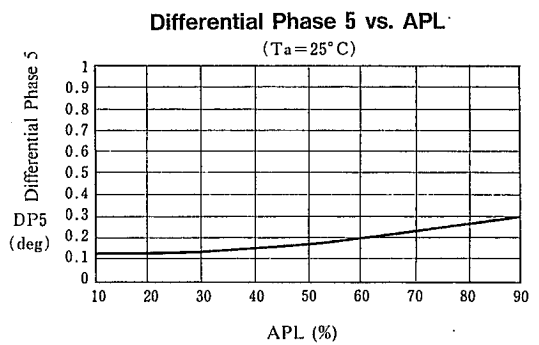
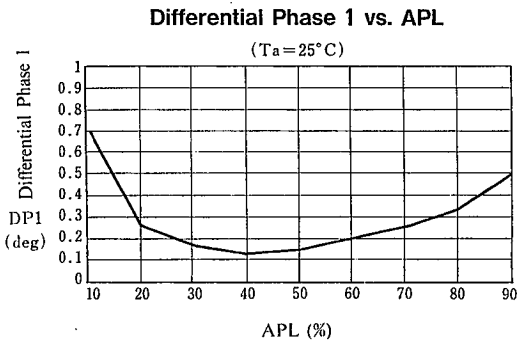
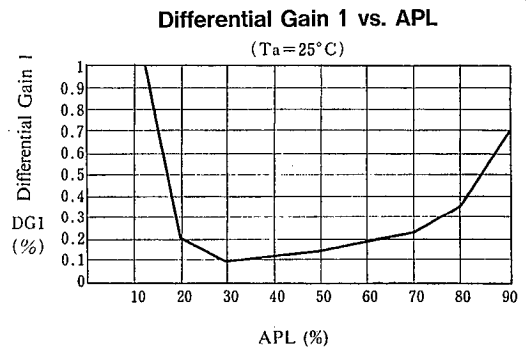
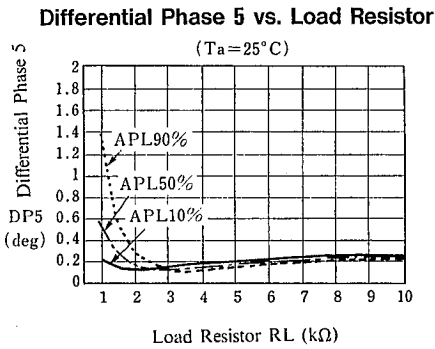
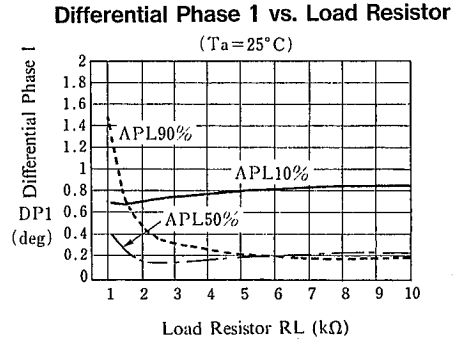
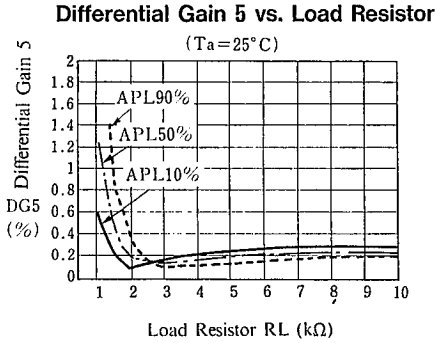

■ TYPICAL CHARACTERISTICS

Total Harmonic Distortion 1 vs. Load Resistor

($T_a=25^{\circ}\text{C}$)

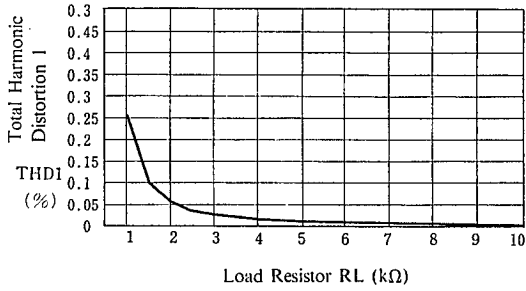

5

MEMO

[CAUTION]

The specifications on this databook are only given for information, without any guarantee as regards either mistakes or omissions. The application circuits in this databook are described only to show representative usages of the product and not intended for the guarantee or permission of any right including the industrial rights.