

### Features

- Rail to Rail Output Swing

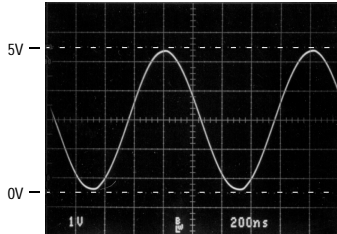

- -3 dB Bandwidth = 100 MHz
- Single Supply +5V operation
- Power Down to 2.6  $\mu$ A
- Large Input Common Mode Range  $0V < V_{CM} < 3.5 V$
- Diff Gain/Phase = 0.1%/0.1 $^\circ$
- Low Power 35mW per amplifier
- Space Saving SOT23-5, MSOP-8&10, & QSOP-16 packaging

### Applications

- Video Amplifier
- 5 Volt Analog Signal Processing
- Multiplexer
- Line Driver
- Portable Computers
- High Speed Communications
- Sample & Hold Amplifier
- Comparator

### Ordering Information

Part No	Temp. Range	Package	Outline #
EL5144CW	-40°C to +85°C	5 Pin SOT23	MDP0038
EL5146CN	-40°C to +85°C	8 Pin PDIP	MDP0031
EL5146CS	-40°C to +85°C	8 Pin SOIC	MDP0027
EL5244CN	-40°C to +85°C	8 Pin PDIP	MDP0031
EL5244CS	-40°C to +85°C	8 Pin SOIC	MDP0027
EL5244CY	-40°C to +85°C	8 Pin MSOP	MDP0043
EL5246CN	-40°C to +85°C	14 Pin PDIP	MDP0031
EL5246CS	-40°C to +85°C	14 Pin SOIC	MDP0027
EL5246CY	-40°C to +85°C	10 Pin MSOP	MDP0043
EL5444CN	-40°C to +85°C	14 Pin PDIP	MDP0031
EL5444CS	-40°C to +85°C	14 Pin SOIC	MDP0027
EL5444CU	-40°C to +85°C	16 Pin QSOP	MDP0040

### General Description

The EL5144C series amplifiers are voltage feedback, high speed, rail to rail amplifiers designed to operate on a single +5V supply. They offer unity gain stability with an unloaded -3dB bandwidth of 100 MHz. The input common mode voltage range extends from the negative rail to within 1.5V of the positive rail. Driving a 75 $\Omega$  double terminated coaxial cable, the EL5144C series amplifiers drive to within 150 mV of either rail. The 200 V/ $\mu$ sec slew rate and 0.1% / 0.1 $^\circ$  differential gain / differential phase makes these parts ideal for composite and component video applications. With its voltage feedback architecture, this amplifier can accept reactive feedback networks, allowing them to be used in analog filtering applications. These amplifiers will source 90 mA and sink 65 mA.

The EL5146C and EL5246C have a power-savings disable feature. Applying a standard TTL low logic level to the CE (Chip Enable) pin reduces the supply current to 2.6  $\mu$ A within 10 nsec. Turn on time is 500 nsec, allowing true break-before-make conditions for multiplexing applications. Allowing the CE pin to float or applying a high logic level will enable the amplifier.

For applications where board space is critical, singles are offered in a SOT23-5 package, duals in MSOP-8 and MSOP-10 packages, and quads in a QSOP-16 package. Singles, duals and quads are also available in industry standard pinouts in SOIC and PDIP packages. All parts operate over the industrial temperature range of -40°C to +85°C.

### Pin Configurations

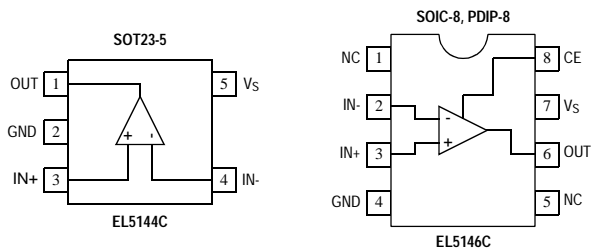

Dual and Quad Amplifier Pin Configurations on Page 12

# EL5144C, EL5146C, EL5244C, EL5246C, EL5444C

100 MHz Single Supply Rail to Rail Amplifier

## Absolute Maximum Ratings (T<sub>A</sub> = 25 °C)

Values beyond absolute maximum ratings can cause the device to be prematurely damaged. Absolute maximum ratings are stress ratings only and functional device operation is not implied.

Supply Voltage between V<sub>S</sub> and GND +6V  
Maximum Continuous Output Current 50mA

Power Dissipation See Curves  
Pin Voltages GND - 0.5V to V<sub>S</sub> +0.5V  
Storage Temperature -65°C to +150°C  
Operating Temperature -40°C to +85°C  
Lead Temperature 260°C

### Important Note:

All parameters having Min/Max specifications are guaranteed. Typ values are for information purposes only. Unless otherwise noted, all tests are at the specified temperature and are pulsed tests, therefore: T<sub>J</sub> = T<sub>C</sub> = T<sub>A</sub>.

## Electrical Characteristics

V<sub>S</sub>=+5V, GND=0V, T<sub>A</sub>=25°C, CE = +2V, unless otherwise specified.

Parameter	Description	Conditions	Min	Typ	Max	Units
<b>AC Performance</b>						
dG	Differential Gain Error <sup>[1]</sup>	G=2, R <sub>L</sub> =150Ω to 2.5V, R <sub>F</sub> =1KΩ		0.1		%
dP	Differential Phase Error <sup>[1]</sup>	G=2, R <sub>L</sub> =150Ω to 2.5V, R <sub>F</sub> =1KΩ		0.1		deg
BW	Bandwidth	-3dB, G=1, R <sub>L</sub> =10kΩ, R <sub>F</sub> =0		100		MHz
		-3dB, G=1, R <sub>L</sub> =150Ω, R <sub>F</sub> =0		60		MHz
BW1	Bandwidth	±0.1dB, G=1, R <sub>L</sub> =150Ω to GND, R <sub>F</sub> =0		8		MHz
GBWP	Gain Bandwidth Product			60		MHz
SR	Slew Rate	G=1, R <sub>L</sub> =150Ω to GND, R <sub>F</sub> =0, V <sub>O</sub> =0.5V to 3.5V	150	200		V/μs
t <sub>s</sub>	Settling Time	to 0.1%, V <sub>OUT</sub> = 0 to 3V		35		ns
<b>DC Performance</b>						
A <sub>VOL</sub>	Open Loop Voltage Gain	R <sub>L</sub> =no load, V <sub>OUT</sub> =0.5V to 3V	54	65		dB
		R <sub>L</sub> =150Ω to GND, V <sub>OUT</sub> =0.5V to 3V	40	50		dB
V <sub>OS</sub>	Offset Voltage	V <sub>CM</sub> =1V, SOT23-5 and MSOP packages			25	mV
		V <sub>CM</sub> =1V, All other packages			15	mV
T <sub>C</sub> V <sub>OS</sub>	Input Offset Voltage Temperature Coefficient			10		μV/°C
I <sub>B</sub>	Input Bias Current	V <sub>CM</sub> =0V & 3.5V		2	100	nA
<b>Input Characteristics</b>						
CMIR	Common Mode Input Range	CMRR ≥ 47dB	0		3.5	V
CMRR	Common Mode Rejection Ratio	DC, V <sub>CM</sub> = 0 to 3.0V	50	60		dB
		DC, V <sub>CM</sub> = 0 to 3.5V	47	60		dB
R <sub>IN</sub>	Input Resistance			1.5		GΩ
C <sub>IN</sub>	Input Capacitance			1.5		pF
<b>Output Characteristics</b>						
V <sub>OP</sub>	Positive Output Voltage Swing	R <sub>L</sub> =150Ω to 2.5V <sup>[2]</sup>	4.70	4.85		V
		R <sub>L</sub> =150Ω to GND <sup>[2]</sup>	4.20	4.65		V
		R <sub>L</sub> =1KΩ to 2.5V <sup>[2]</sup>	4.95	4.97		V
V <sub>ON</sub>	Negative Output Voltage Swing	R <sub>L</sub> =150Ω to 2.5V <sup>[2]</sup>		0.15	0.30	V
		R <sub>L</sub> =150Ω to GND <sup>[2]</sup>		0		V
		R <sub>L</sub> =1K to 2.5V <sup>[2]</sup>		0.03	0.05	V
+I <sub>OUT</sub>	Positive Output Current	R <sub>L</sub> =10Ω to 2.5V	60	90	120	mA

# *EL5144C, EL5146C, EL5244C, EL5246C, EL5444C*

*100 MHz Single Supply Rail to Rail Amplifier*

EL5144C, EL5146C, EL5244C, EL5246C, EL5444C

## Electrical Characteristics

$V_S=+5V$ ,  $GND=0V$ ,  $T_A=25^\circ C$ ,  $CE = +2V$ , unless otherwise specified.

Parameter	Description	Conditions	Min	Typ	Max	Units
$-I_{OUT}$	Negative Output Current	$R_L=10\Omega$ to 2.5V	-50	-65	-80	mA
<b>Enable (EL5146C &amp; EL5246C Only)</b>						
$t_{EN}$	Enable Time	EL5146C, EL5246C		500		nS
$t_{DIS}$	Disable Time	EL5146C, EL5246C		10		nS
$I_{HCE}$	CE pin Input High Current	$CE = 5V$ , EL5146C, EL5246C		0.003	1	$\mu A$
$I_{LCE}$	CE pin Input Low Current	$CE = 0V$ , EL5146C, EL5246C		-1.2	-3	$\mu A$
$V_{IHCE}$	CE pin Input High Voltage for Power Up	EL5146C, EL5246C	2.0			V
$V_{ILCE}$	CE pin Input Low Voltage for Power Down	EL5146C, EL5246C			0.8	V
<b>Supply</b>						
$I_{SON}$	Supply Current - Enabled (per amplifier)	No Load, $V_{IN}=0V$ , $CE=5V$		7	8.8	mA
$I_{SOFF}$	Supply Current - Disabled (per amplifier)	No Load, $V_{IN}=0V$ , $CE=0V$		2.6	5	$\mu A$
PSOR	Power Supply Operating Range		4.75	5.0	5.25	V
PSRR	Power Supply Rejection Ratio	DC, $V_S = 4.75V$ to 5.25V	50	60		dB

- Standard NTSC test, AC signal amplitude = 286 mV<sub>p-p</sub>, f=3.58 MHz, V<sub>OUT</sub> is swept from 0.8V to 3.4V, R<sub>L</sub> is DC coupled
- R<sub>L</sub> is Total Load Resistance due to Feedback Resistor and Load Resistor

# EL5144C, EL5146C, EL5244C, EL5246C, EL5444C

100 MHz Single Supply Rail to Rail Amplifier

## Typical Performance Curves

**Non-Inverting Frequency Response (Gain)**  
 $V_{CM} = 1.5V, R_L = 150\Omega$

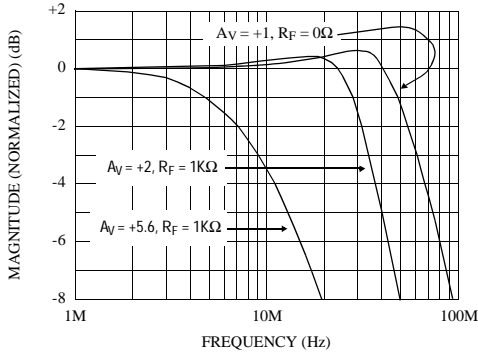

**Non-Inverting Frequency Response (Phase)**  
 $V_{CM} = 1.5V, R_L = 150\Omega$

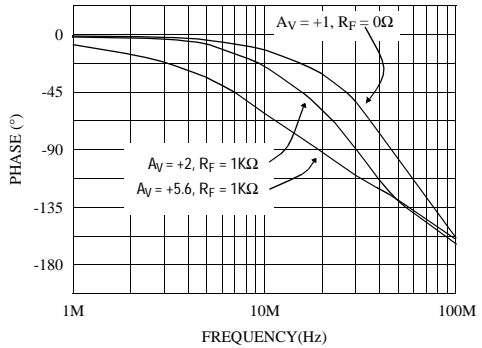

**Inverting Frequency Response (Gain)**  
 $V_{CM} = 1.5V, R_F = 1K\Omega, R_L = 150\Omega$

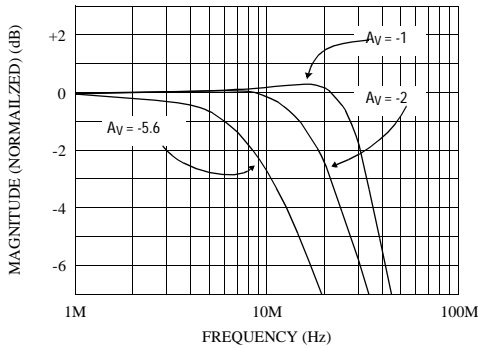

**Inverting Frequency Response (Phase)**  
 $V_{CM} = 1.5V, R_F = 1K\Omega, R_L = 150\Omega$

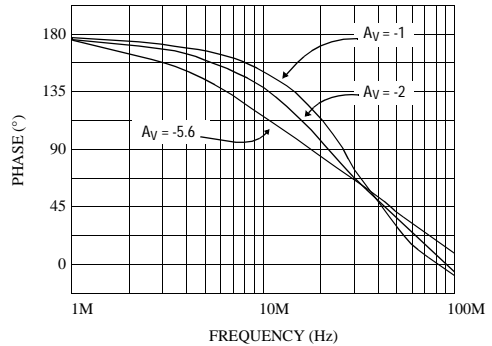

**3dB Bandwidth vs. Die Temperature for Various Gains**  
 $R_L = 150\Omega$

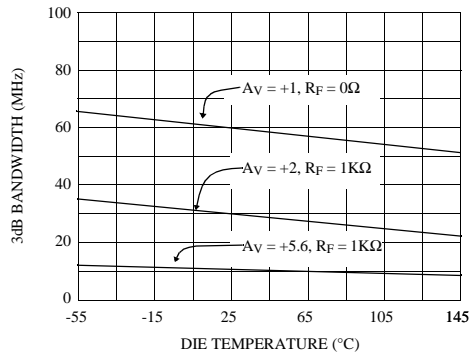

**3dB Bandwidth vs. Die Temperature for Various Gains**  
 $R_L = 10K\Omega$

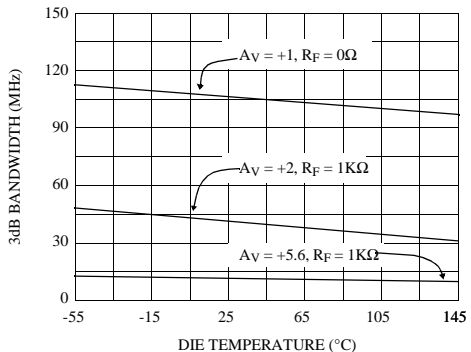

# EL5144C, EL5146C, EL5244C, EL5246C, EL5444C

100 MHz Single Supply Rail to Rail Amplifier

EL5144C, EL5146C, EL5244C, EL5246C, EL5444C

**Frequency Response for Various  $R_L$**   
 $V_{CM} = 1.5V, R_F = 0\Omega, A_V = +1$

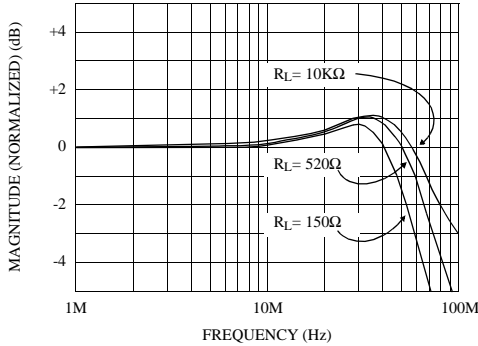

**Frequency Response for Various  $C_L$**   
 $V_{CM} = 1.5V, R_L = 150\Omega, A_V = +1$

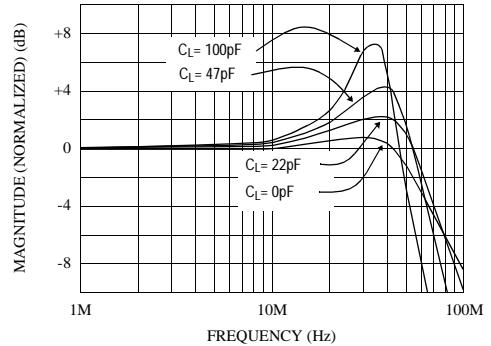

**Frequency Response for Various  $R_F$  and  $R_G$**   
 $V_{CM} = 1.5V, R_L = 150\Omega, A_V = +2$

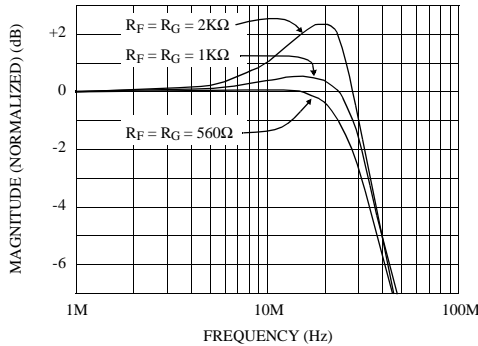

**Group Delay vs. Frequency**

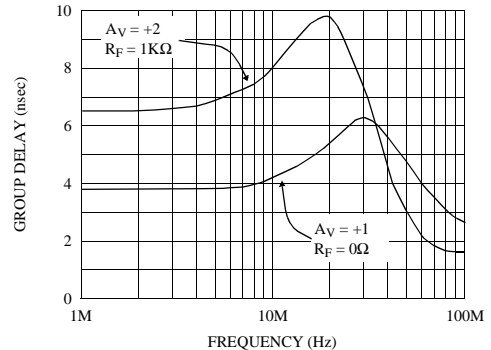

**Open Loop Gain and Phase vs. Frequency**

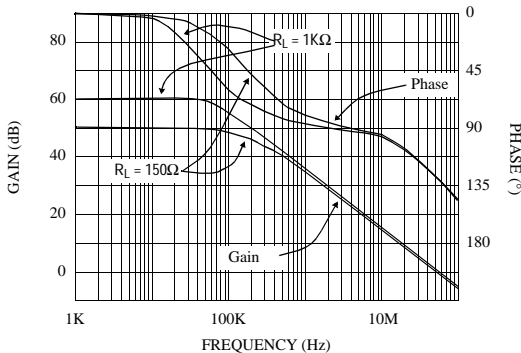

**Open Loop Voltage Gain vs. Die Temperature**

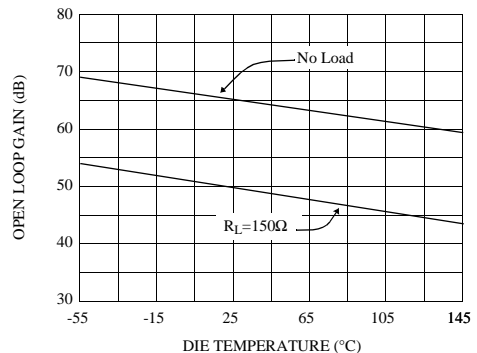

# EL5144C, EL5146C, EL5244C, EL5246C, EL5444C

100 MHz Single Supply Rail to Rail Amplifier

Voltage Noise vs. Frequency

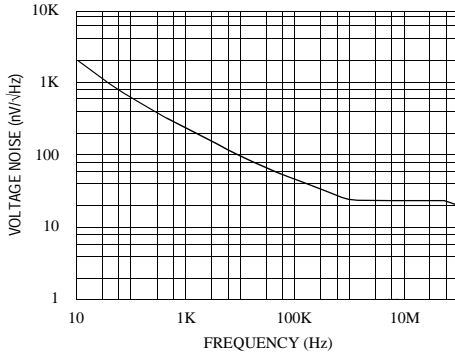

Closed Loop Output Impedance vs. Frequency

$R_F = 0, A_V = +1$

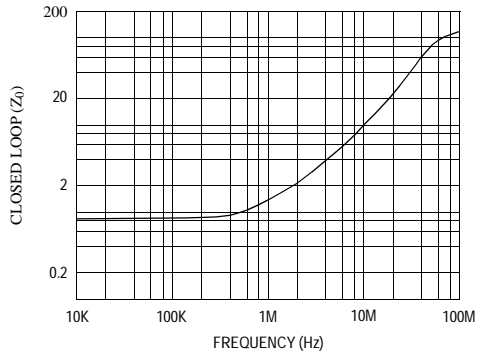

Offset Voltage vs. Die Temperature  
(6 Typical Samples)

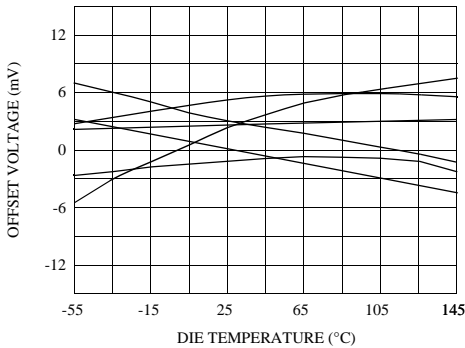

PSRR and CMRR vs. Frequency

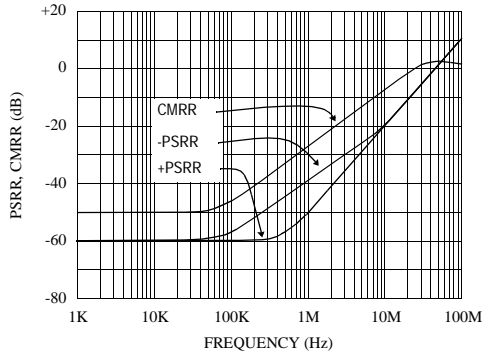

Output Voltage Swing vs. Frequency for THD < 1%

$R_F = 1K\Omega, A_V = +2$

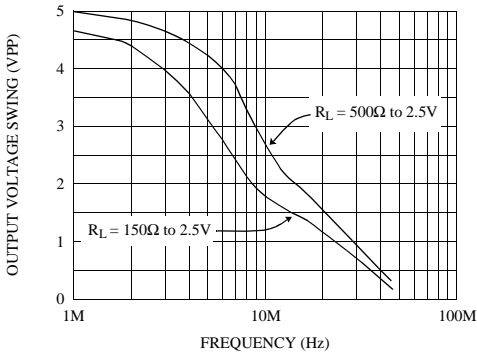

Output Voltage Swing vs. Frequency for THD < 0.1%

$R_F = 1K\Omega, A_V = +2$

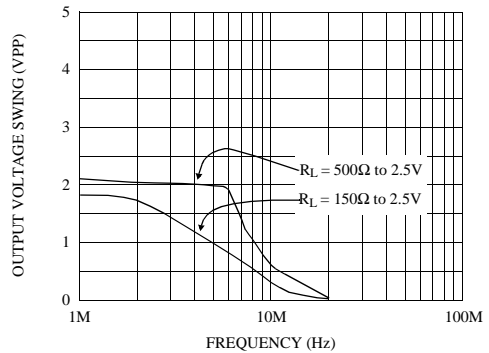

# EL5144C, EL5146C, EL5244C, EL5246C, EL5444C

100 MHz Single Supply Rail to Rail Amplifier

EL5144C, EL5146C, EL5244C, EL5246C, EL5444C

**Large Signal Pulse Response (Single Supply)**

$V_S = +5V$ ,  $R_L = 150\Omega$  to  $0V$ ,  $R_F = 1K\Omega$ ,  $A_V = +2$

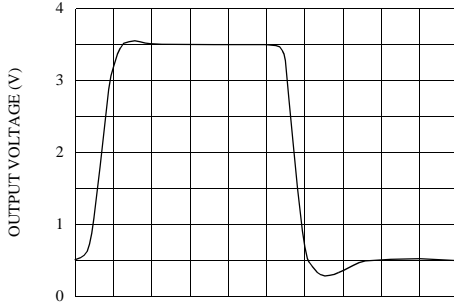

TIME (20ns/DIV)

**Small Signal Pulse Response (Single Supply)**

$V_S = +5V$ ,  $R_L = 150\Omega$  to  $0V$ ,  $R_F = 1K\Omega$ ,  $A_V = +2$

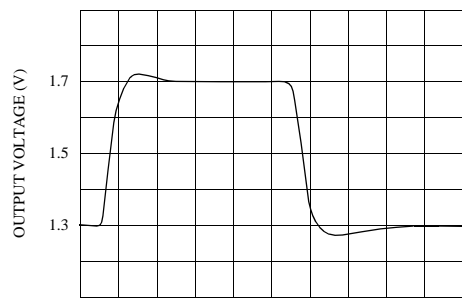

TIME (20ns/DIV)

**Large Signal Pulse Response (Split Supplies)**

$V_S = \pm 2.5V$ ,  $R_L = 150\Omega$  to  $0V$ ,  $R_F = 1K\Omega$ ,  $A_V = +2$

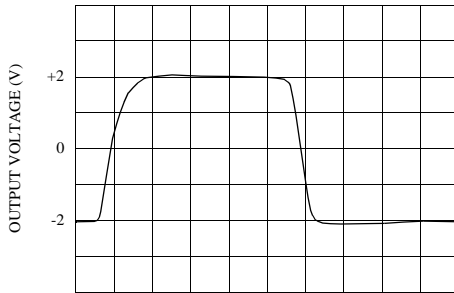

TIME (20ns/DIV)

**Small Signal Pulse Response (Split Supply)**

$V_S = \pm 2.5V$ ,  $R_L = 150\Omega$  to  $0V$ ,  $R_F = 1K\Omega$ ,  $A_V = +2$

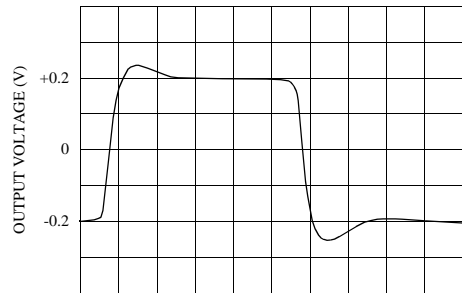

TIME (20ns/DIV)

**Settling Time vs. Settling Accuracy**

$R_L = 1K\Omega$ ,  $R_F = 500\Omega$ ,  $A_V = -1$ ,  $V_{STEP} = 3V$

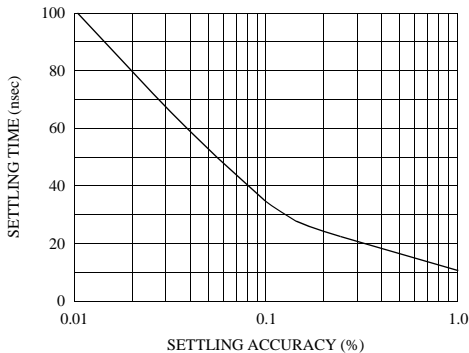

**Slew Rate vs. Die Temperature**

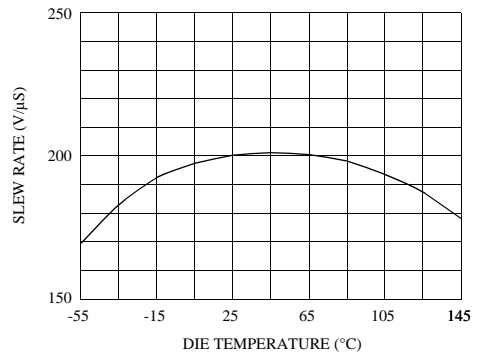

# EL5144C, EL5146C, EL5244C, EL5246C, EL5444C

100 MHz Single Supply Rail to Rail Amplifier

**Differential Gain for  $R_L$  Tied to 0V**  
 $R_F = 0, A_V = +1$

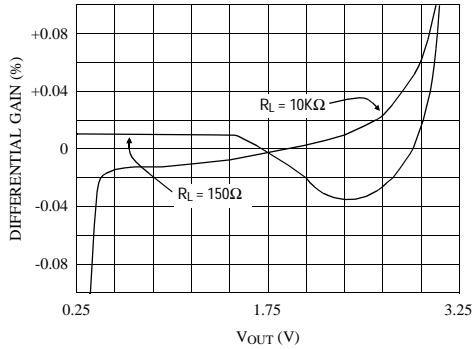

**Differential Phase for  $R_L$  Tied to 0V**  
 $R_F = 0, A_V = +1$

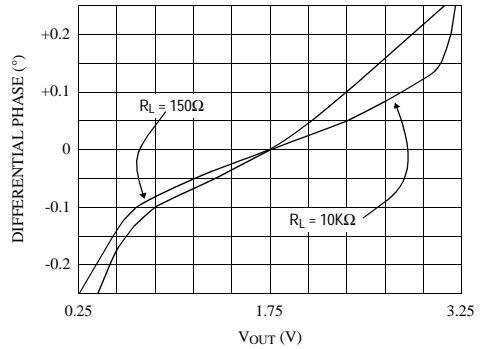

**Differential Gain for  $R_L$  Tied to 2.5V**  
 $R_F = 0, A_V = +1$

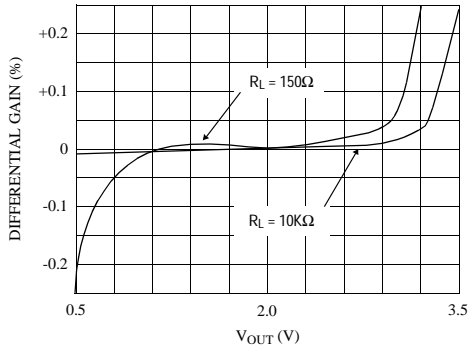

**Differential Phase for  $R_L$  Tied to 2.5V**  
 $R_F = 0, A_V = +1$

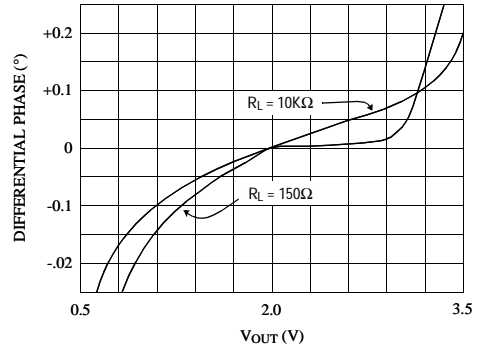

**Differential Gain for  $R_L$  Tied to 0V**  
 $R_F = 1KΩ, A_V = +2$

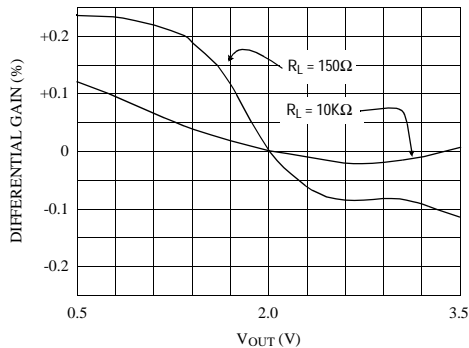

**Differential Phase for  $R_L$  Tied to 0V**  
 $R_F = 1KΩ, A_V = +2$

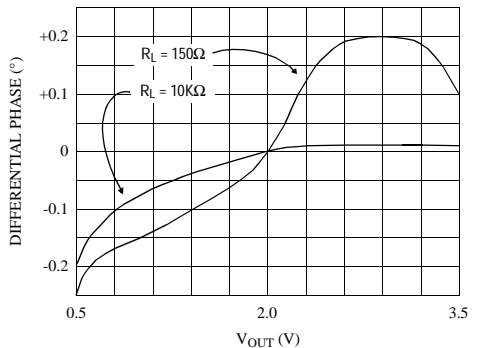



# EL5144C, EL5146C, EL5244C, EL5246C, EL5444C

100 MHz Single Supply Rail to Rail Amplifier

EL5144C, EL5146C, EL5244C, EL5246C, EL5444C

**Differential Gain for  $R_L$  Tied to 2.5V**  
 $R_F = 1K\Omega$ ,  $A_V = +2$

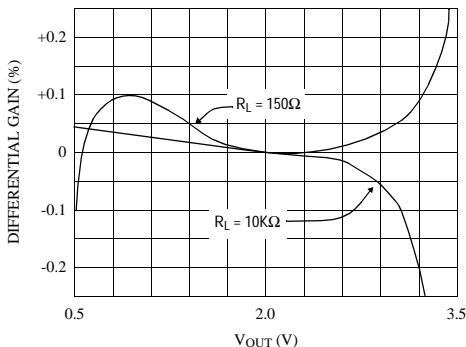

**Differential Phase for  $R_L$  Tied to 2.5V**  
 $R_F = 1K\Omega$ ,  $A_V = +2$

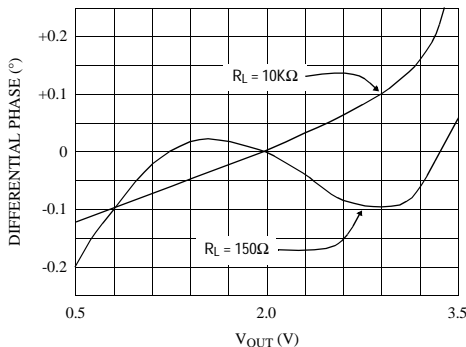

**2nd and 3rd Harmonic Distortion vs. Frequency**  
 $V_{OUT} = 0.25V$  to  $2.25V$ ,  $R_L = 100\Omega$  to  $0V$

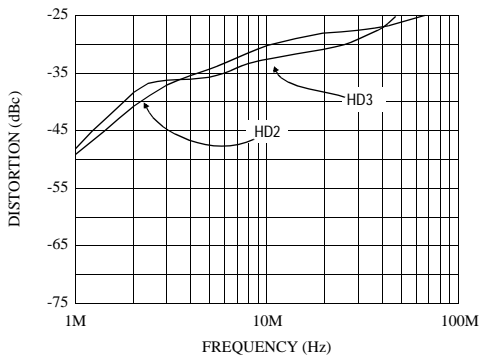

**2nd and 3rd Harmonic Distortion vs. Frequency**  
 $V_{OUT} = 0.5V$  to  $2.5V$ ,  $R_L = 100\Omega$  to  $0V$

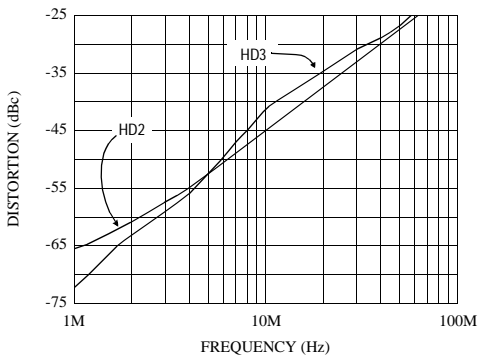

**2nd and 3rd Harmonic Distortion vs. Frequency**  
 $V_{OUT} = 1V$  to  $3V$ ,  $R_L = 100\Omega$  to  $0V$

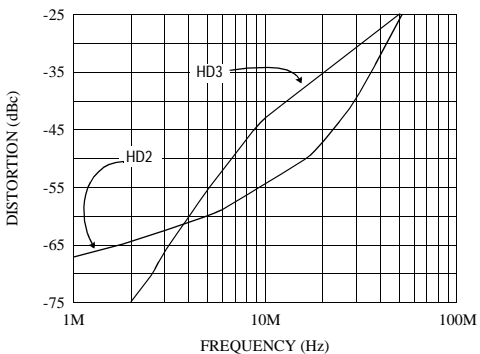

**Channel to Channel Crosstalk- Duals and Quads (Worst Channel)**

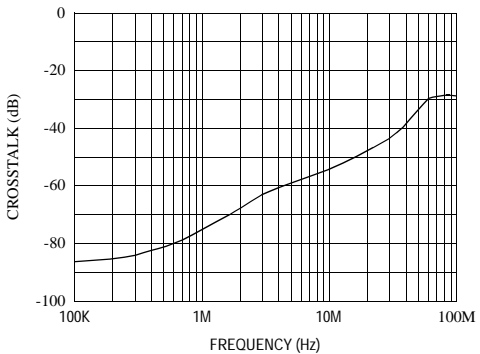

# EL5144C, EL5146C, EL5244C, EL5246C, EL5444C

100 MHz Single Supply Rail to Rail Amplifier

**Supply Current (per Amp) vs. Supply Voltage**

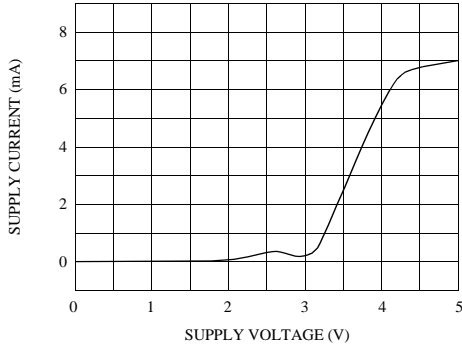

**Output Current vs. Die Temperature**  
 $R_L = 10\Omega$  to 2.5V

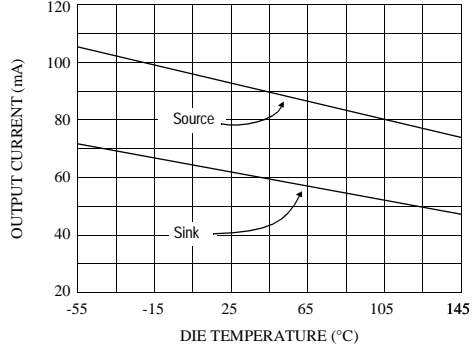

**Supply Current - ON (per amp) vs. Die Temperature**

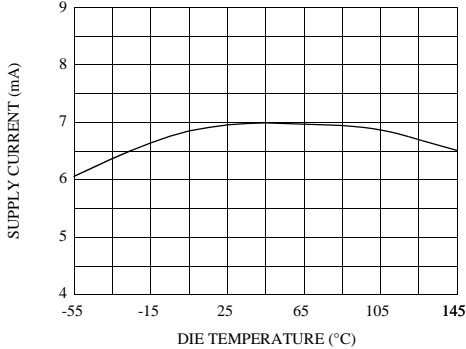

**Supply Current - OFF (per amp) vs. Die Temperature**

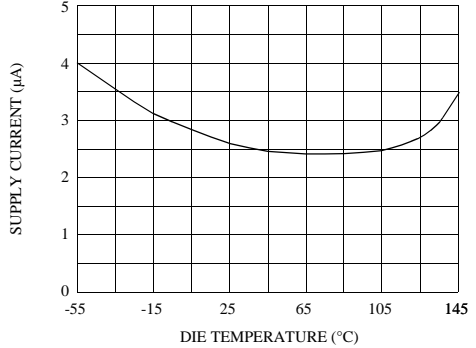

**Positive Output Voltage Swing vs. Die Temperature**  
 $R_L = 150\Omega$

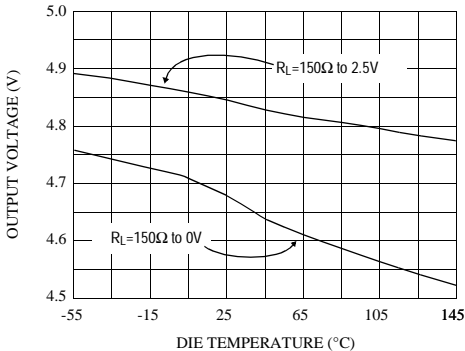

**Negative Output Voltage Swing vs. Die Temperature**

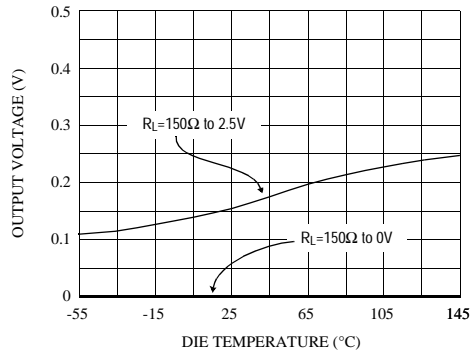

# EL5144C, EL5146C, EL5244C, EL5246C, EL5444C

100 MHz Single Supply Rail to Rail Amplifier

EL5144C, EL5146C, EL5244C, EL5246C, EL5444C

**Output Voltage from Either Rail vs. Die Temperature for Various Effective  $R_{LOAD}$**

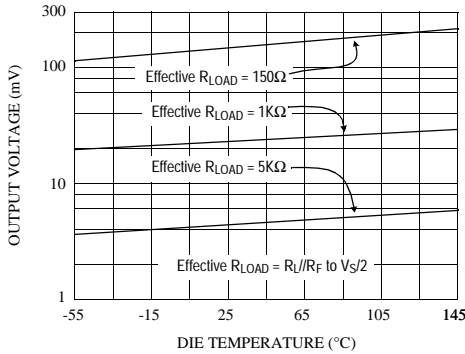

**OFF Isolation - EL5146C & EL5246C**

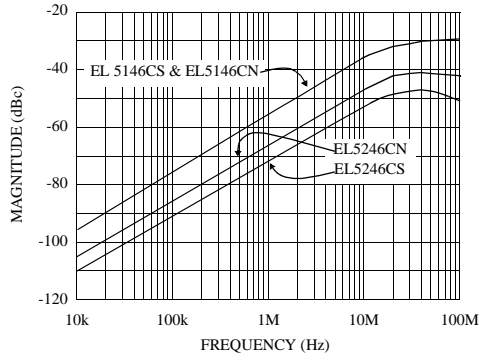

**Maximum Power Dissipation vs. Ambient Temperature Singles ( $T_{JMAX} = 150^\circ\text{C}$ )**

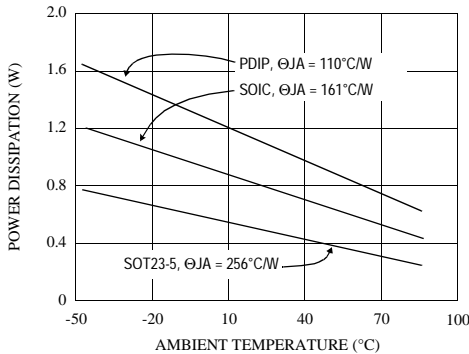

**Maximum Power Dissipation vs. Ambient Temperature Duals ( $T_{JMAX} = 150^\circ\text{C}$ )**

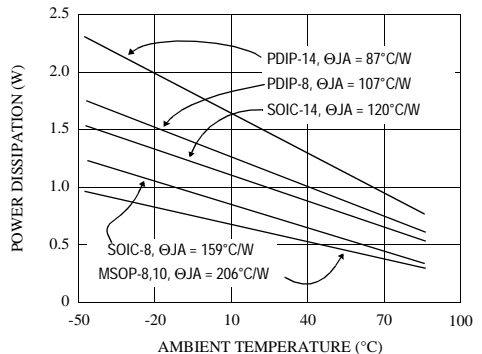

**Maximum Power Dissipation vs. Ambient Temperature Quads ( $T_{JMAX} = 150^\circ\text{C}$ )**

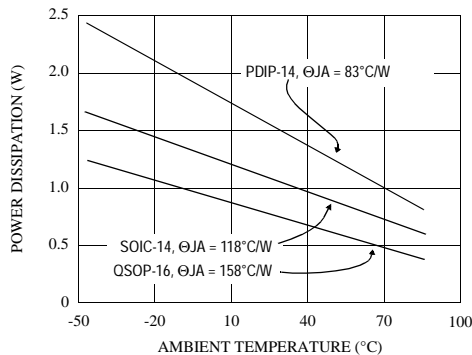

# EL5144C, EL5146C, EL5244C, EL5246C, EL5444C

100 MHz Single Supply Rail to Rail Amplifier

## Pin Configurations

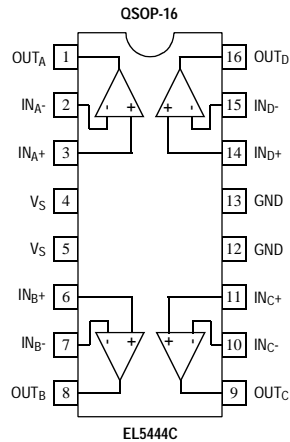
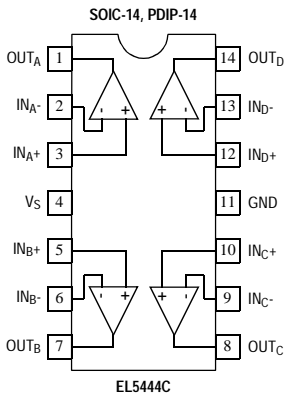
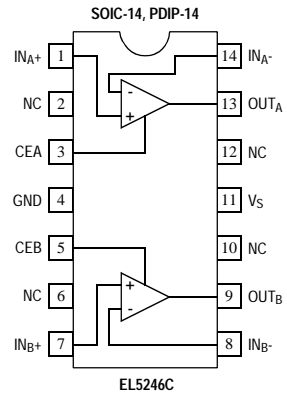
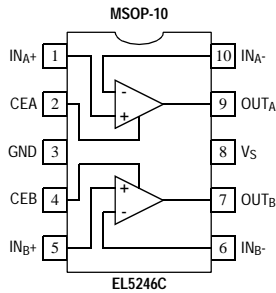
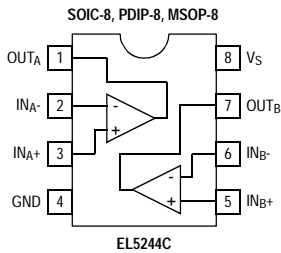

Single Amplifier Pin Configurations on Page 1

# EL5144C, EL5146C, EL5244C, EL5246C, EL5444C

*100 MHz Single Supply Rail to Rail Amplifier*

EL5144C, EL5146C, EL5244C, EL5246C, EL5444C

## Pin Description

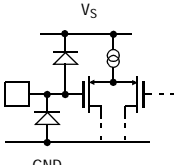
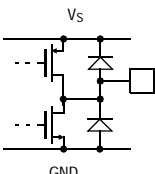
EL5144C (SOT23-5)	EL5146C (SO/PDIP)	EL5244C (SO/PDIP/MSOP)	EL5246C (MSOP)	EL5246C (SO/PDIP)	EL5444C (SO/PDIP)	EL5444C (QSOP)	Name	Function	Equivalent Circuit
5	7	8	8	11	4	4,5	V <sub>S</sub>	Positive Power Supply	
2	4	4	3	4	11	12,13	GND	Ground or Negative Power Supply	
3	3						IN+	Noninverting Input	 <p style="text-align: center;">Circuit 1</p>
4	2						IN-	Inverting Input	(Reference Circuit 1)
1	6						OUT	Amplifier Output	 <p style="text-align: center;">Circuit 2</p>
		3	1	1	3	3	IN <sub>A+</sub>	Amplifier A Noninverting Input	(Reference Circuit 1)
		2	10	14	2	2	IN <sub>A-</sub>	Amplifier A Inverting Input	(Reference Circuit 1)
		1	9	13	1	1	OUT <sub>A</sub>	Amplifier A Output	(Reference Circuit 2)
		5	5	7	5	6	IN <sub>B+</sub>	Amplifier B Noninverting Input	(Reference Circuit 1)
		6	6	8	6	7	IN <sub>B-</sub>	Amplifier B Inverting Input	(Reference Circuit 1)
		7	7	9	7	8	OUT <sub>B</sub>	Amplifier B Output	(Reference Circuit 2)
					10	11	IN <sub>C+</sub>	Amplifier C Noninverting Input	(Reference Circuit 1)
					9	10	IN <sub>C-</sub>	Amplifier C Inverting Input	(Reference Circuit 1)
					8	9	OUT <sub>C</sub>	Amplifier C Output	(Reference Circuit 2)
					12	14	IN <sub>D+</sub>	Amplifier D Noninverting Input	(Reference Circuit 1)
					13	15	IN <sub>D-</sub>	Amplifier D Inverting Input	(Reference Circuit 1)
					14	16	OUT <sub>D</sub>	Amplifier D Output	(Reference Circuit 2)

# EL5144C, EL5146C, EL5244C, EL5246C, EL5444C

100 MHz Single Supply Rail to Rail Amplifier

## Pin Description

EL5144C (SOT23-5)	EL5146C (SO/PDIP)	EL5244C (SO/PDIP/MSOP)	EL5246C (MSOP)	EL5246C (SO/PDIP)	EL5444C (SO/PDIP)	EL5444C (QSOP)	Name	Function	Equivalent Circuit
	8						CE	Enable (Enabled when high)	<p>Circuit 3</p>
			2	3			CEA	Enable Amplifier A (Enabled when high)	(Reference Circuit 3)
			4	5			CEB	Enable Amplifier B (Enabled when high)	(Reference Circuit 3)
	1,5			2,6, 10,12			NC	No Connect. Not internally connected.	

# *EL5144C, EL5146C, EL5244C, EL5246C, EL5444C*

*100 MHz Single Supply Rail to Rail Amplifier*

EL5144C, EL5146C, EL5244C, EL5246C, EL5444C

## **Description of Operation and Applications Information**

### **Product Description**

The EL5144C series is a family of wide bandwidth, single supply, low power, rail-to-rail output, voltage feedback operational amplifiers. The family includes single, dual, and quad configurations. The singles and duals are available with a power down pin to reduce power to 2.6 $\mu$ A typically. All the amplifiers are internally compensated for closed loop feedback gains of +1 or greater. Larger gains are acceptable but bandwidth will be reduced according to the familiar Gain-Bandwidth Product.

Connected in voltage follower mode and driving a high impedance load, the EL5144C series has a -3dB bandwidth of 100 MHz. Driving a 150 $\Omega$  load, they have a -3dB bandwidth of 60 MHz while maintaining a 200 V/ $\mu$ S slew rate. The input common mode voltage range includes ground while the output can swing rail to rail.

### **Power Supply Bypassing and Printed Circuit Board Layout**

As with any high-frequency device, good printed circuit board layout is necessary for optimum performance. Ground plane construction is highly recommended. Lead lengths should be as short as possible. The power supply pin must be well bypassed to reduce the risk of oscillation. For normal single supply operation, where the GND pin is connected to the ground plane, a single 4.7  $\mu$ F tantalum capacitor in parallel with a 0.1  $\mu$ F

ceramic capacitor from  $V_S$  to GND will suffice. This same capacitor combination should be placed at each supply pin to ground if split supplies are to be used. In this case, the GND pin becomes the negative supply rail.

For good AC performance, parasitic capacitance should be kept to a minimum. Use of wire wound resistors should be avoided because of their additional series inductance. Use of sockets, particularly for the SO package, should be avoided if possible. Sockets add parasitic inductance and capacitance that can result in compromised performance.

### **Input, Output, and Supply Voltage Range**

The EL5144C series has been designed to operate with a single supply voltage of 5V. Split supplies can be used so long as their total range is 5V.

The amplifiers have an input common mode voltage range that includes the negative supply (GND pin) and extends to within 1.5V of the positive supply ( $V_S$  pin). They are specified over this range.

The output of the EL5144C series amplifiers can swing rail to rail. As the load resistance becomes lower in value, the ability to drive close to each rail is reduced. However, even with an effective 150  $\Omega$  load resistor connected to a voltage halfway between the supply rails, the output will swing to within 150mV of either rail.

# EL5144C, EL5146C, EL5244C, EL5246C, EL5444C

## 100 MHz Single Supply Rail to Rail Amplifier

Figure 1 shows the output of the EL5144C series amplifier swinging rail to rail with  $R_F = 1\text{K}\Omega$ ,  $A_V = +2$  and  $R_L = 1\text{M}\Omega$ . Figure 2 is with  $R_L = 150\Omega$ .

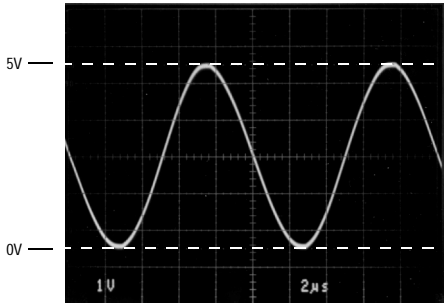

Figure 1

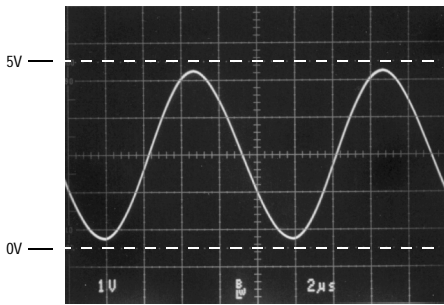

Figure 2

### Choice of Feedback Resistor, $R_F$

These amplifiers are optimized for applications that require a gain of +1. Hence, no feedback resistor is required. However, for gains greater than +1, the feedback resistor forms a pole with the input capacitance. As this pole becomes larger, phase margin is reduced. This causes ringing in the time domain and peaking in the frequency domain. Therefore,  $R_F$  has some maximum value that should not be exceeded for optimum performance. If a large value of  $R_F$  must be used, a small capacitor in the few picofarad range in parallel with  $R_F$  can help to reduce this ringing and peaking at the expense of reducing the bandwidth.

As far as the output stage of the amplifier is concerned,  $R_F + R_G$  appear in parallel with  $R_L$  for gains other than

+1. As this combination gets smaller, the bandwidth falls off. Consequently,  $R_F$  also has a minimum value that should not be exceeded for optimum performance.

For  $A_V = +1$ ,  $R_F = 0\Omega$  is optimum. For  $A_V = -1$  or +2 (noise gain of 2), optimum response is obtained with  $R_F$  between  $300\Omega$  and  $1\text{K}\Omega$ . For  $A_V = -4$  or +5 (noise gain of 5), keep  $R_F$  between  $300\Omega$  and  $15\text{K}\Omega$ .

### Video Performance

For good video signal integrity, an amplifier is required to maintain the same output impedance and the same frequency response as DC levels are changed at the output. This can be difficult when driving a standard video load of  $150\Omega$ , because of the change in output current with DC level. A look at the Differential Gain and Differential Phase curves for various supply and loading conditions will help you obtain optimal performance. Curves are provided for  $A_V = +1$  and +2, and  $R_L = 150\Omega$  and  $10\text{K}\Omega$  tied both to ground as well as 2.5V. As with all video amplifiers, there is a common mode sweet spot for optimum differential gain / differential phase. For example, with  $A_V = +2$  and  $R_L = 150\Omega$  tied to 2.5V, and the output common mode voltage kept between 0.8V and 3.2V, dG/dP is a very low  $0.1\% / 0.1^\circ$ . This condition corresponds to driving an AC-coupled, double terminated  $75\Omega$  coaxial cable. With  $A_V = +1$ ,  $R_L = 150\Omega$  tied to ground, and the video level kept between 0.85V and 2.95V, these amplifiers provide dG/dP performance of  $0.05\% / 0.20^\circ$ . This condition is representative of using the EL5144C series amplifier as a buffer driving a DC coupled, double terminated,  $75\Omega$  coaxial cable. Driving high impedance loads, such as signals on computer video cards, gives similar or better dG/dP performance as driving cables.

### Driving Cables and Capacitive Loads

The EL5144C series amplifiers can drive  $50\text{pF}$  loads in parallel with  $150\Omega$  with 4dB of peaking and  $100\text{pF}$  with 7dB of peaking. If less peaking is desired in these applications, a small series resistor (usually between  $5\Omega$  and  $50\Omega$ ) can be placed in series with the output to eliminate most peaking. However, this will obviously reduce the gain slightly. If your gain is greater than 1, the gain resistor ( $R_G$ ) can then be chosen to make up for any gain



# *EL5144C, EL5146C, EL5244C, EL5246C, EL5444C*

*100 MHz Single Supply Rail to Rail Amplifier*

EL5144C, EL5146C, EL5244C, EL5246C, EL5444C

loss which may be created by this additional resistor at the output. Another method of reducing peaking is to add a “snubber” circuit at the output. A snubber is a resistor in a series with a capacitor, 150Ω and 100pF being typical values. The advantage of a snubber is that it does not draw DC load current.

When used as a cable driver, double termination is always recommended for reflection-free performance. For those applications, the back-termination series resistor will de-couple the EL5144C series amplifier from the cable and allow extensive capacitive drive. However, other applications may have high capacitive loads without a back-termination resistor. Again, a small series resistor at the output can reduce peaking.

## **Disable / Power-Down**

The EL5146C and EL5246C amplifiers can be disabled, placing its output in a high-impedance state. Turn off time is only 10 nsec and turn on time is around 500 nsec. When disabled, the amplifier’s supply current is reduced to 2.6μA typically, thereby effectively eliminating power consumption. The amplifier’s power down can be controlled by standard TTL or CMOS signal levels at the CE pin. The applied logic signal is relative to the GND pin. Letting the CE pin float will enable the amplifier. Hence, the 8 pin PDIP and SOIC single amps are pin compatible with standard amplifiers that don’t have a power down feature.

## **Short Circuit Current Limit**

The EL5144C series amplifiers do not have internal short circuit protection circuitry. Short circuit current of 90 mA sourcing and 65 mA sinking typically will flow if the output is trying to drive high or low but is shorted to half way between the rails. If an output is shorted indefinitely, the power dissipation could easily increase such that the part will be destroyed. Maximum reliability is maintained if the output current never exceeds ±50mA. This limit is set by internal metal interconnect limitations. Obviously, short circuit conditions must not remain or the internal metal connections will be destroyed.

## **Power Dissipation**

With the high output drive capability of the EL5144C series amplifiers, it is possible to exceed the 150°C Absolute Maximum junction temperature under certain load current conditions. Therefore, it is important to calculate the maximum junction temperature for the application to determine if load conditions or package type need to be modified for the amplifier to remain in the safe operating area.

The maximum power dissipation allowed in a package is determined according to:

$$PD_{MAX} = \frac{T_{JMAX} - T_{AMAX}}{\Theta_{JA}}$$

where:

T<sub>JMAX</sub> = Maximum Junction Temperature

T<sub>AMAX</sub> = Maximum Ambient Temperature

Θ<sub>JA</sub> = Thermal Resistance of the Package

PD<sub>MAX</sub> = Maximum Power Dissipation

in the Package.

The maximum power dissipation actually produced by an IC is the total quiescent supply current times the total power supply voltage, plus the power in the IC due to the load, or:

$$PD_{MAX} = N \cdot \left( V_S \cdot I_{SMAX} + (V_S - V_{OUT}) \cdot \frac{V_{OUT}}{R_L} \right)$$

where:

N = Number of amplifiers in the package

V<sub>S</sub> = Total Supply Voltage

# EL5144C, EL5146C, EL5244C, EL5246C, EL5444C

## 100 MHz Single Supply Rail to Rail Amplifier

$I_{SMAX}$  = Maximum Supply Current Per Amplifier  
 $V_{OUT}$  = Maximum Output Voltage of the Application  
 $R_L$  = Load Resistance tied to Ground

If we set the two  $PD_{MAX}$  equations equal to each other, we can solve for  $R_L$ :

$$R_L = \frac{V_{OUT} \cdot (V_S - V_{OUT})}{\left( \frac{T_{JMAX} - T_{AMAX}}{N \cdot \Theta_{JA}} \right) - (V_S \cdot I_{SMAX})}$$

Assuming worst case conditions of  $T_A = +85^\circ\text{C}$ ,  $V_{out} = V_S/2$  V,  $V_S = 5.5\text{V}$ , and  $I_{SMAX} = 8.8\text{mA}$  per amplifier, below is a table of all packages and the minimum  $R_L$  allowed.

Part	Package	Minimum $R_L$
EL5144CW	SOT23-5	37
EL5146CS	SOIC-8	21
EL5146CN	PDIP-8	14
EL5244CS	SOIC-8	48
EL5244CN	PDIP-8	30
EL5244CY	MSOP-8	69
EL5246CY	MSOP-10	69
EL5246CS	SOIC-14	34
EL5246CN	PDIP-14	23
EL5444CU	QSOP-16	139
EL5444CS	SOIC-14	85
EL5444CN	PDIP-14	51

### EL5144C Series Comparator Application

The EL5144C series amplifier can be used as a very fast, single supply comparator. Most op amps used as a comparator allow only slow speed operation because of output saturation issues. The EL5144C series amplifier doesn't suffer from output saturation issues. Figure 3 shows the amplifier implemented as a comparator. Fig-

ure 4 is a graph of propagation delay vs. overdrive as a square wave is presented at the input of the comparator.

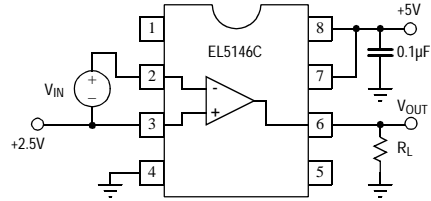

Figure 3

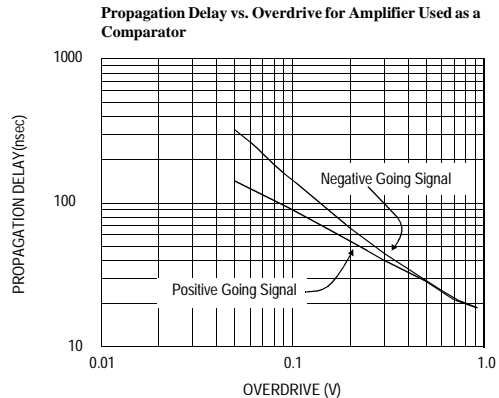

Figure 4

### Multiplexing with the EL5144C Series Amplifier

Besides normal power down usage, the CE (Chip Enable) pin on the EL5146C and EL5246C series amplifiers also allow for multiplexing applications. Figure 5 shows an EL5246C with its outputs tied together, driving a back terminated 75Ω video load. A 3 Vp-p 10 MHz sine wave is applied at Amp A input, and a 2.4 Vp-p 5 MHz square wave to Amp B. Figure 6 shows the SELECT signal that is applied, and the resulting output waveform at  $V_{OUT}$ . Observe the break-before-make operation of the multiplexing. Amp A is on and  $V_{IN1}$  is being passed through to the output of the amplifier. Then Amp A turns off in about 10 nsec. The output decays to

# EL5144C, EL5146C, EL5244C, EL5246C, EL5444C

100 MHz Single Supply Rail to Rail Amplifier

EL5144C, EL5146C, EL5244C, EL5246C, EL5444C

ground with an  $R_L C_L$  time constants. 500 nsec later, Amp B turns on and  $V_{IN2}$  is passed through to the output. This break-before-make operation ensures that more than one amplifier isn't trying to drive the bus at the same time. Notice the outputs are tied directly together. Isolation resistors at each output are not necessary.

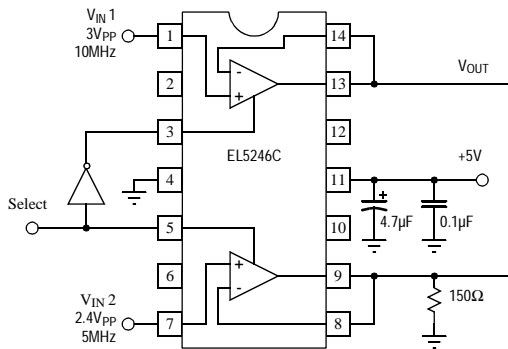

Figure 5

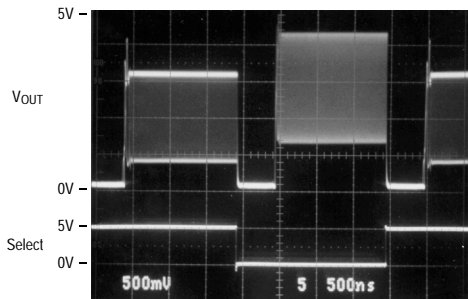

Figure 6

## Free Running Oscillator Application

Figure 7 is an EL5144C configured as a free running oscillator. To first order,  $R_{OSC}$  and  $C_{OSC}$  determine the frequency of oscillation according to:

$$F_{OSC} = \frac{0.72}{R_{OSC} \cdot C_{OSC}}$$

For rail to rail output swings, maximum frequency of oscillation is around 15 MHz. If reduced output swings are acceptable, 25 MHz can be achieved. Figure 8 shows the oscillator for  $R_{OSC} = 510 \Omega$ ,  $C_{OSC} = 240 \text{ pF}$  and  $F_{OSC} = 6 \text{ MHz}$ .

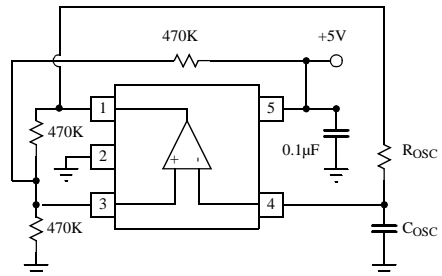

Figure 7

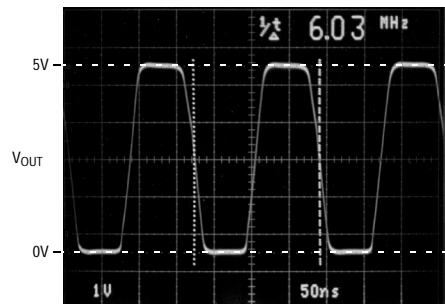

Figure 8

# *EL5144C, EL5146C, EL5244C, EL5246C, EL5444C*

*100 MHz Single Supply Rail to Rail Amplifier*

## **General Disclaimer**

Specifications contained in this data sheet are in effect as of the publication date shown. Elantec, Inc. reserves the right to make changes in the circuitry or specifications contained herein at any time without notice. Elantec, Inc. assumes no responsibility for the use of any circuits described herein and makes no representations that they are free from patent infringement.



HIGH PERFORMANCE ANALOG INTEGRATED CIRCUITS

## **Elantec Semiconductor, Inc.**

675 Trade Zone Blvd.  
Milpitas, CA 95035  
Telephone: (408) 945-1323  
Fax: (408) 945-9305  
Toll Free: 1 - (888) ELANTEC  
Web Site: <http://www.elantec.com>  
European Office: 44-118-977-6020  
Japan Tech Center: 81-45-682-5820

## **WARNING - Life Support Policy**

Elantec, Inc. products are not authorized for and should not be used within Life Support Systems without the specific written consent of Elantec, Inc. Life Support systems are equipment intended to support or sustain life and whose failure to perform when properly used in accordance with instructions provided can be reasonably expected to result in significant personal injury or death. Users contemplating application of Elantec, Inc. Products in Life Support Systems are requested to contact Elantec, Inc. factory headquarters to establish suitable terms & conditions for these applications. Elantec, Inc.'s warranty is limited to replacement of defective components and does not cover injury to persons or property or other consequential damages.