

BIPOLAR ANALOG INTEGRATED CIRCUIT
 μ PC1379C

SYNCHRONIZATION SIGNAL PROCESSOR FOR B/W TV
AND SMALL-SIZED COLOR TV

μ PC 1379C is a bipolar analog integrated circuit designed for mono-chrome TV and small size color TV.

It contains synchronous signal separator, vertical deflection signal generator, vertical power stage, and horizontal deflection signal generator in a molded 16 pins dual in-line package.

The package has a tab attaching to the end.

The vertical stage reduces the power consumption remarkably by the built-in voltage booster circuit. The horizontal signal part can take the working power from any voltage power supply higher than 8 volts, as it equips shunt type power regulator itself. So, it can take the power even from 110 volt power line through only one resistor.

FEATURES

- Built-in vertical power stage remarkably low power vertical deflection realized by the built-in voltage booster.
- Vertical fly-back pulse width is freely adjustable by the exclusive terminal.
- Any supply voltage is available for the horizontal part, as it equips shunt type power regulator itself.

BLOCK DIAGRAM

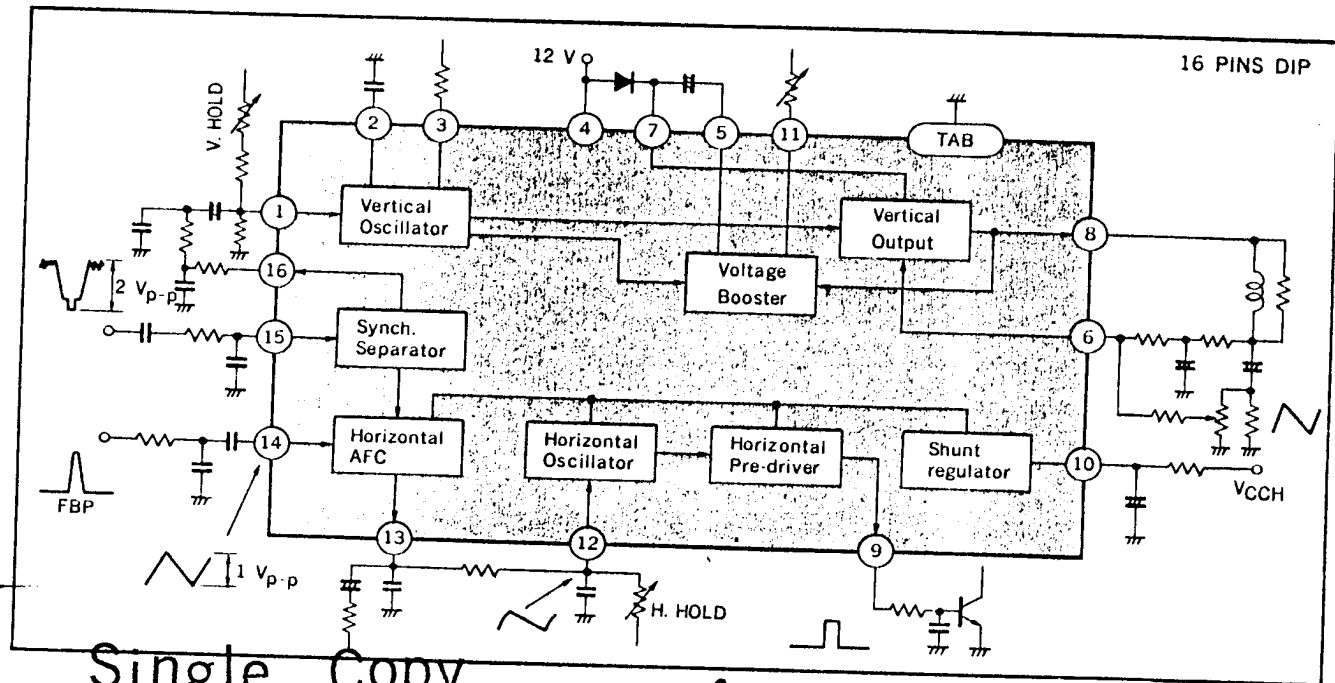

Single Copy

62 UNITS orig

Handle With Care

006104

6104

NEC

NEC cannot assume any responsibility for any circuits shown or represent that they are free from patent infringement.

Nippon Electric Co., Ltd.

PACKAGE DIMENSIONS (Unit : mm)

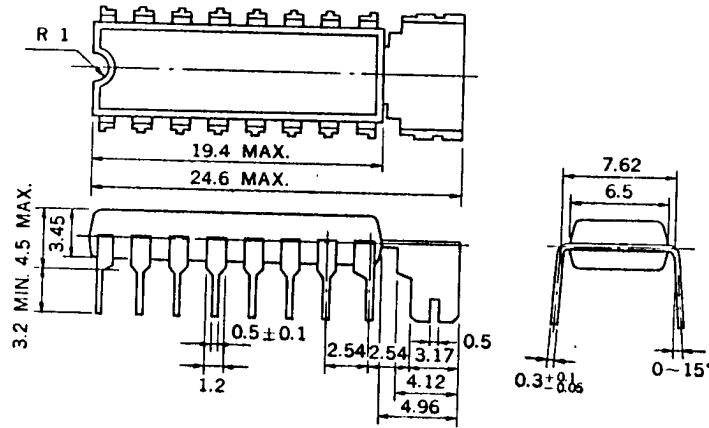

CONNECTION DIAGRAM (Top View)

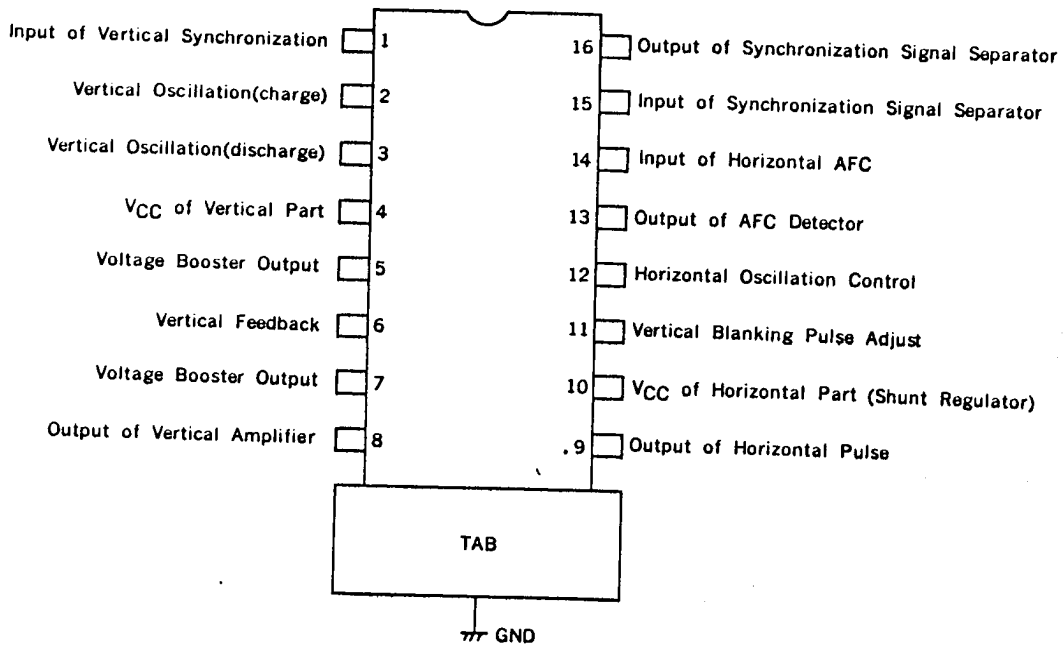

ABSOLUTE MAXIMUM RATINGS (T_a = 25 °C)

(Mark(+)) of current expresses that the current is flowing into the terminal. Mark(-) of current expresses that the current is flowing out from the terminal.

Power Supply Voltage for Vertical Part	V ₄	15	V
Power Supply Current for Horizontal Part	I ₁₀	30	mA
Video Input Voltage	V ₁₅	V ₄	V
Synch Output Current	I ₁₆	-10 to +10	mA
Voltage Booster Charge Voltage	V ₁₁	V ₄	V
Booster Output Current	I ₅	-500 to +150	mA _{peak}
Deflection Current	I ₈	-500 to +150	mA _{peak}
Vertical Feedback Voltage	V ₆	V ₄	V
AFC Input Voltage	V ₁₄	V ₁₀	V
Horizontal Output Current (Pulse)	I ₉	-5 to +5	mA
Power Dissipation	P _D	1.3 (T _{tab} = 98 °C)	W
Thermal Resistance (J-tab)	R _{th(j-tab)}	40 (T _{tab} = 25 °C)	°C/W
Thermal Resistance (J-a)	R _{th(j-a)}	70 (T _a = 25 °C)	°C/W
Operating Temperature	T _{opt}	-20 to +75	°C
Storage Temperature	T _{stg}	-40 to +150	°C

RECOMMENDED OPERATING CONDITIONS

CHARACTERISTIC	SYMBOL	MIN.	TYP.	MAX.	UNIT
Power Supply Voltage for the Vertical Part	V ₄	9.6	12	14.4	V
Deflection Current	I _{DEF}	400	500	600	mA _{p-p}
Power Supply Current for Horizontal Part	I ₁₀	6.5	12	18	mA

ELECTRICAL CHARACTERISTICS (T_a = 25 °C, V₄ = 12 V, I_{DEF} = 500 mA_{p-p}, I₁₀ = 12 mA)

CHARACTERISTIC	SYMBOL	MIN.	TYP.	MAX.	UNIT	CONDITIONS
Power Supply Current for Vertical Part	I ₄₍₁₎		85	100	mA	standard circuit
Power Supply Current for Vertical Part	I ₄₍₂₎	6	12	20	mA	standard circuit (Idling Current)
Vertical Free-running Frequency	f _{VO}	46	50	54	Hz	standard circuit
Drift of Vertical Free-running Frequency	Δf _{VO(VCC)}		0.8	2.0	Hz	Δf _{VO(VCC)} = f _{VO(9.6 V)} - f _{VO(14.4 V)}
Drift of Vertical Free-running Frequency	Δf _{VO(T_a)}		1.5	2.0	Hz	Δf _{VO(T_a)} = f _{VO(-20 °C)} - f _{VO(+75 °C)}
Vertical Synchronizing Capture Frequency	f _{PV}	47	50		Hz	f _{V(in)} = 60 Hz
Middle Voltage of Vertical Output	V _{MID}	5.3	5.8	6.3	V	standard circuit
Flyback Pulse Peak Voltage	RPV	20	23	26	V	standard circuit
Flyback Pulse Width	RPW	790	850	910	μs	standard circuit
Deflection Current	I _{DEF}	450	500	550	mA _{p-p}	standard circuit
Supply Voltage for Horizontal Part	V ₁₀	6.2	6.7	7.2	V	I ₁₀ = 12 mA
Horizontal Free-running Frequency	f _{HO}	15.0	15.75	16.5	kHz	standard circuit
Drift of Horizontal Free-running Frequency	Δf _{HO(T_a)}		190	250	Hz	Δf _{HO(T_a)} = f _{HO(-20 °C)} - f _{HO(+75 °C)}
Horizontal Output Pulse Width	PWH	23	25	27	μs	standard circuit
Horizontal Output Current	I ₉	0.8	1.3	2.0	mA	standard circuit
Horizontal Synchronizing Capture Freq.	f _{PH}	±650	±900	±1150	Hz	standard circuit
Horizontal AFC Output Current	I ₁₃	0.28	0.45	0.74	mA	standard circuit
Gain of AFC Detector	μ	89	143	236	μA/rad	standard circuit
Efficiency of Horizontal Oscillation Control	β	66	72	78	Hz/μA	standard circuit

TYPICAL CHARACTERISTICS ($T_a = 25^\circ\text{C}$)

1. Vertical part

DRIFT OF VERTICAL OSCILLATION AGAINST POWER SUPPLY VOLTAGE

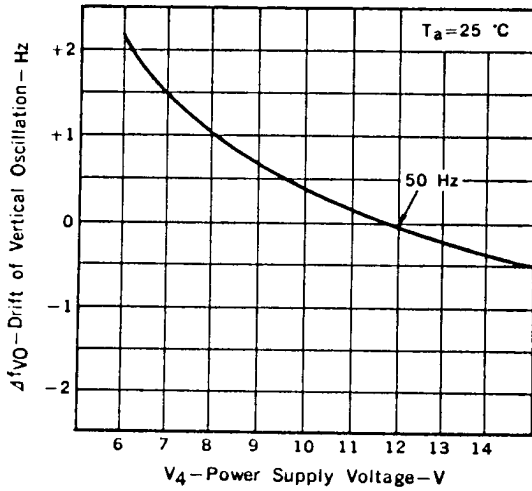

DRIFT OF VERTICAL OSCILLATION AGAINST AMBIENT TEMPERATURE

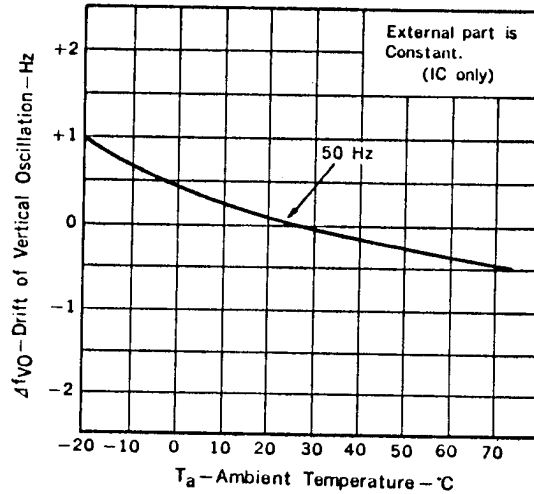

DRIFT OF VERTICAL MIDDLE VOLTAGE AGAINST POWER SUPPLY VOLTAGE

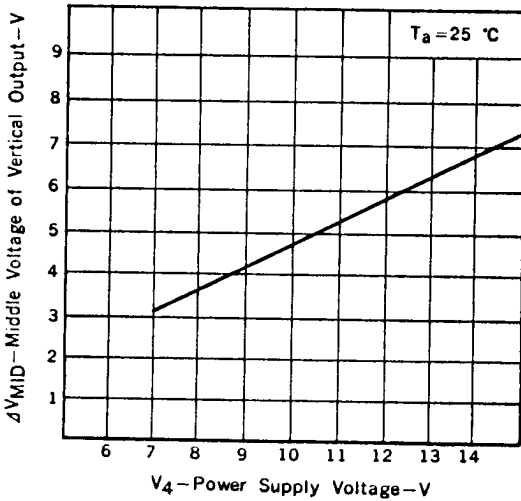

2. Horizontal part

DRIFT OF HORIZONTAL OSCILLATION AGAINST POWER SUPPLY VOLTAGE

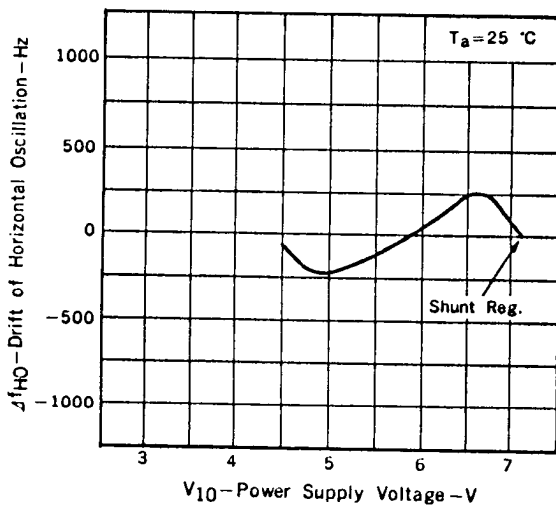

HORIZONTAL POWER SUPPLY CURRENT VERSUS VOLTAGE

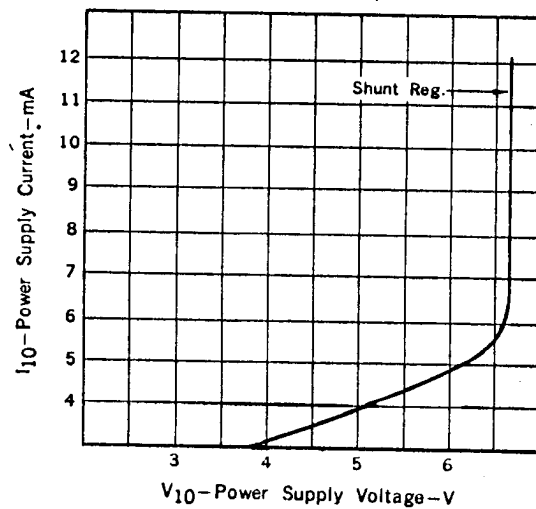

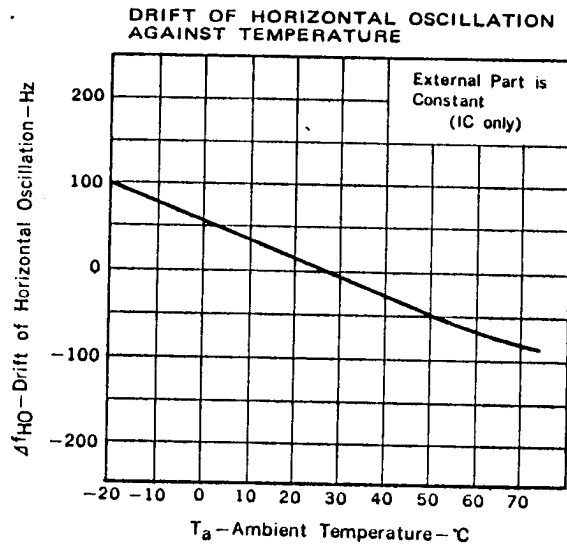
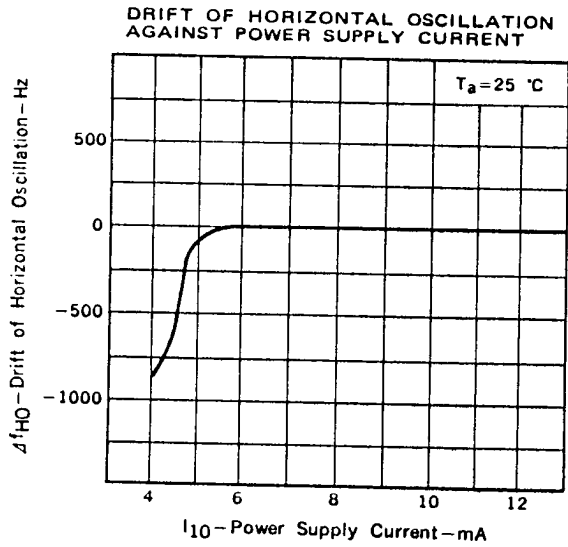

3. $P_D - T_a$ Characteristic

