

KM4200

Dual, Low Cost, +2.7V & +5V, 260MHz Rail-to-Rail Amplifier

Features

- 260MHz bandwidth
- Fully specified at +2.7V and +5V supplies
- Output voltage range: 0.036V to 4.953V;
 $V_S = +5$; $R_L = 2k\Omega$
- Input voltage range: -0.3V to +3.8V; $V_S = +5$
- 145V/ μ s slew rate
- 4.2mA supply current per amplifier
- ± 55 mA linear output current
- ± 85 mA short circuit current
- Directly replaces AD8052 and AD8042 in single supply applications
- Small package options (SOIC and MSOP)

Applications

- A/D driver
- Active filters
- CCD imaging systems
- CD/DVD ROM
- Coaxial cable drivers
- High capacitive load driver
- Portable/battery-powered applications
- Twisted pair driver
- Video driver

KM4200 Packages

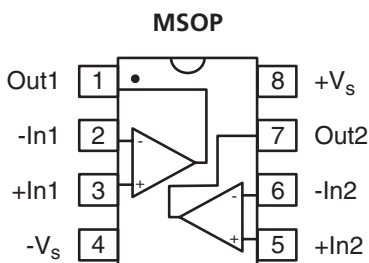
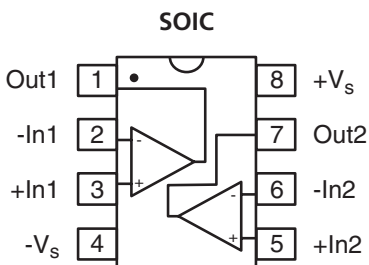

General Description

The KM4200 is a dual, low cost, voltage feedback amplifier. This amplifier is designed to operate on +2.7V, +5V, or ± 2.5 V supplies. The input voltage range extends 300mV below the negative rail and 1.2V below the positive rail. The KM4100 (single) and KM4101 (single with disable) are also available.

The KM4200 offers superior dynamic performance with a 260MHz small signal bandwidth and 145V/ μ s slew rate. The combination of low power, high output current drive, and rail-to-rail performance make the KM4200 well suited for battery-powered communication/computing systems.

The combination of low cost and high performance make the KM4200 suitable for high volume applications in both consumer and industrial applications such as wireless phones, scanners, and color copiers.

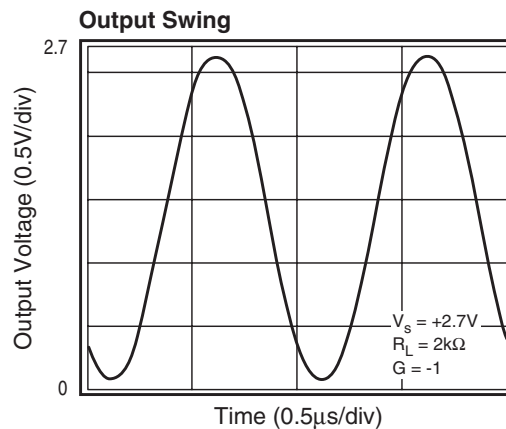

KM4200 Electrical Characteristics ($V_s = +2.7V$, $G = 2$, $R_L = 2k\Omega$ to $V_s/2$; unless noted)

PARAMETERS	CONDITIONS	TYP	MIN & MAX	UNITS	NOTES
Case Temperature		+25°C	+25°C		
Frequency Domain Response					
-3dB bandwidth	$G = +1$, $V_O = 0.05V_{pp}$	215		MHz	1
	$G = +2$, $V_O = 0.2V_{pp}$	85		MHz	
full power bandwidth	$G = +2$, $V_O = 2V_{pp}$	36		MHz	
gain bandwidth product		86		MHz	
Time Domain Response					
rise and fall time	0.2V step	3.7		ns	1
settling time to 0.1%	1V step	40		ns	
overshoot	0.2V step,	9		%	
slew rate	2.7V step, $G = -1$	130		V/ μ s	
Distortion and Noise Response					
2nd harmonic distortion	1V _{pp} , 5MHz	79		dBc	1
3rd harmonic distortion	1V _{pp} , 5MHz	82		dBc	1
THD	1V _{pp} , 5MHz	77		dB	1
input voltage noise	>1MHz	16		nV/ \sqrt Hz	
input current noise	>1MHz	1.3		pA/ \sqrt Hz	
crosstalk	10MHz	65		dB	1
DC Performance					
input offset voltage		-1.6	± 8	mV	2
average drift		10		μ V/ $^{\circ}$ C	
input bias current		3	± 8	μ A	2
average drift		7		nA/ $^{\circ}$ C	
input offset current		0.1	± 1	μ A	2
power supply rejection ratio	DC	57	52	dB	2
open loop gain		75	65	dB	2
quiescent current per amplifier		3.9	5	mA	2
Input Characteristics					
input resistance		4.3		M Ω	
input capacitance		1.8		pF	
input common mode voltage range		-0.3 to 1.5		V	
common mode rejection ratio	DC, $V_{cm} = 0V$ to $V_s - 1.5$	87	72	dB	2
Output Characteristics					
output voltage swing	$R_L = 10k\Omega$ to $V_s/2$	0.023 to 2.66		V	
	$R_L = 2k\Omega$ to $V_s/2$	0.025 to 2.653	0.1 to 2.6	V	2
	$R_L = 150\Omega$ to $V_s/2$	0.065 to 2.55	0.3 to 2.325	V	2
linear output current		± 55		mA	
	-40°C to +85°C	± 50		mA	
short circuit output current		± 85		mA	
power supply operating range		2.7	2.5 to 5.5	V	

Min/max ratings are based on product characterization and simulation. Individual parameters are tested as noted. Outgoing quality levels are determined from tested parameters.

NOTES:

- 1) $R_f = 1k\Omega$ was used for optimal performance. (For $G = +1$, $R_f = 0$)
- 2) 100% tested at +25°C.

Absolute Maximum Ratings

supply voltage	0 to +6V
maximum junction temperature	+175°C
storage temperature range	-65°C to +150°C
lead temperature (10 sec)	+300°C
operating temperature range (recommended)	-40°C to +85°C
input voltage range	+ V_s +0.5V; - V_s -0.5V
internal power dissipation	see power derating curves

Package Thermal Resistance

Package	θ_{JA}
8 lead SOIC	152°C/W
8 lead MSOP	206°C/W

KM4200 Electrical Characteristics ($V_s = +5V$, $G = 2$, $R_L = 2k\Omega$ to $V_s/2$; unless noted)

Parameters	Conditions	TYP	Min & Max	UNITS	NOTES
Case Temperature		+25°C	+25°C		
Frequency Domain Response					
-3dB bandwidth	$G = +1, V_O = 0.05V_{pp}$	260		MHz	1
full power bandwidth	$G = +2, V_O = 0.2V_{pp}$	90		MHz	
gain bandwidth product	$G = +2, V_O = 2V_{pp}$	40		MHz	
		90		MHz	
Time Domain Response					
rise and fall time	0.2V step	3.6		ns	1
settling time to 0.1%	2V step	40		ns	
overshoot	0.2V step,	7		%	
slew rate	5V step, $G = -1$	145		V/ μ s	
Distortion and Noise Response					
2nd harmonic distortion	$2V_{pp}$, 5MHz	71		dBc	1
3rd harmonic distortion	$2V_{pp}$, 5MHz	78		dBc	1
THD	$2V_{pp}$, 5MHz	70		dB	1
input voltage noise	>1MHz	16		nV/ \sqrt Hz	
input current noise	>1MHz	1.3		pA/ \sqrt Hz	
crosstalk	10MHz	62		dB	1
DC Performance					
input offset voltage		1.4	± 8	mV	2
average drift		10		μ V/ $^{\circ}$ C	
input bias current		3	± 8	μ A	2
average drift		7		nA/ $^{\circ}$ C	
input offset current		0.1	± 0.8	μ A	2
power supply rejection ratio	DC	57	52	dB	2
open loop gain		78	68	dB	2
quiescent current per amplifier		4.2	5.2	mA	2
Input Characteristics					
input resistance		4.3		M Ω	
input capacitance		1.8		pF	
input common mode voltage range		-0.3 to 3.8		V	
common mode rejection ratio	DC, $V_{cm} = 0V$ to $V_s - 1.5$	87	72	dB	2
Output Characteristics					
output voltage swing	$R_L = 10k\Omega$ to $V_s/2$	0.027 to 4.97		V	
	$R_L = 2k\Omega$ to $V_s/2$	0.036 to 4.953	0.1 to 4.9	V	2
	$R_L = 150\Omega$ to $V_s/2$	0.12 to 4.8	0.3 to 4.625	V	2
linear output current		± 55		mA	
		± 50		mA	
short circuit output current		± 85		mA	
power supply operating range	-40°C to +85°C	5	2.5 to 5.5	V	

Min/max ratings are based on product characterization and simulation. Individual parameters are tested as noted. Outgoing quality levels are determined from tested parameters.

NOTES:

- 1) $R_f = 1k\Omega$ was used used for optimal performance. (For $G = +1$, $R_f = 0$)
- 2) 100% tested at +25°C.

KM4200 Performance Characteristics ($V_s = +5V$, $G = 2$, $R_f = 2k\Omega$, $R_L = 2k\Omega$ to $V_s/2$; unless noted)

Non-Inverting Freq. Response $V_s = +5V$

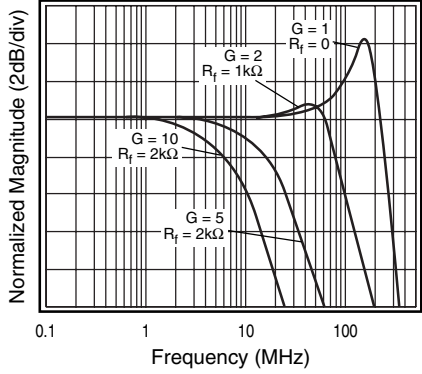

Inverting Frequency Response $V_s = +5V$

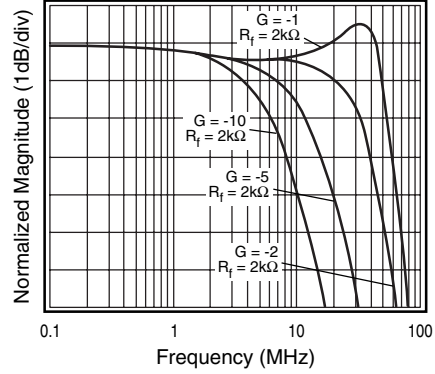

Non-Inverting Freq. Response $V_s = +2.7V$

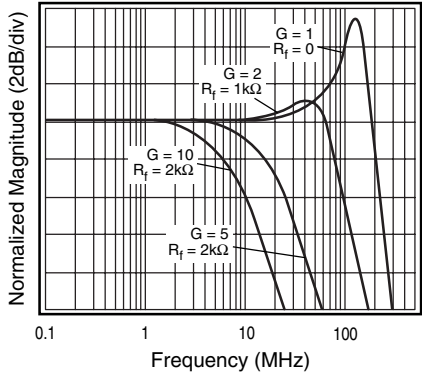

Inverting Frequency Response $V_s = +2.7V$

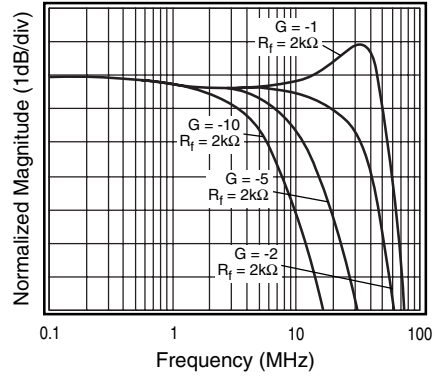

Frequency Response vs. C_L

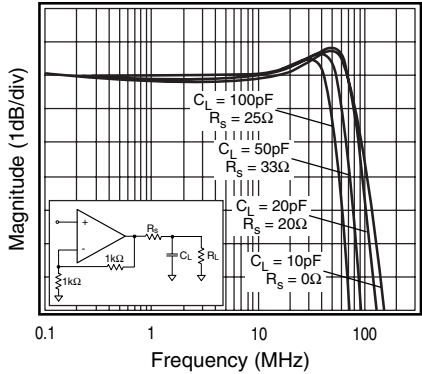

Large Signal Frequency Response

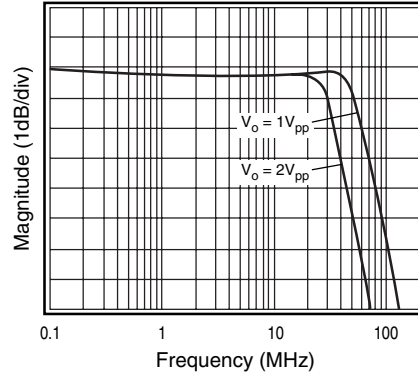

Frequency Response vs. Temperature

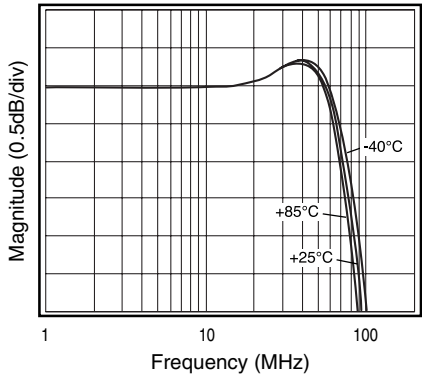

Input Voltage Noise

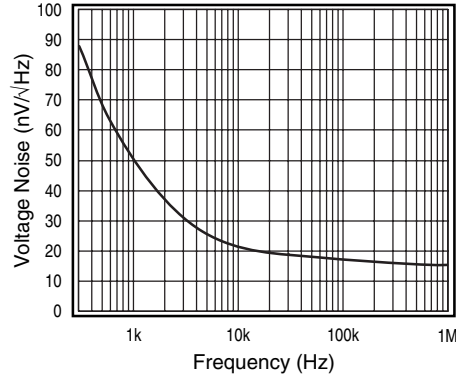

KM4200 Performance Characteristics ($V_s = +5V$, $G = 2$, $R_f = 2k\Omega$, $R_L = 2k\Omega$ to $V_s/2$; unless noted)

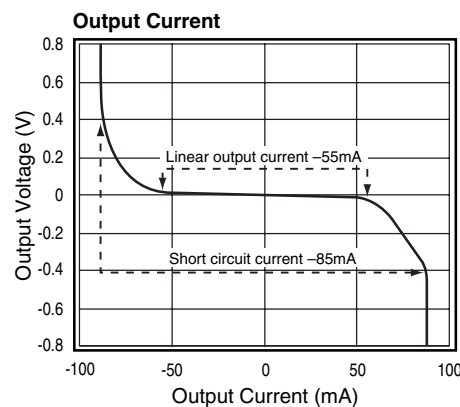
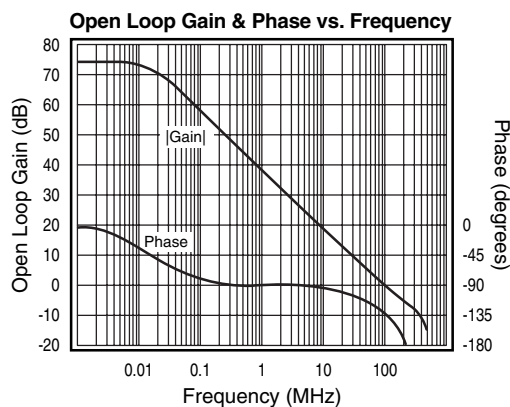
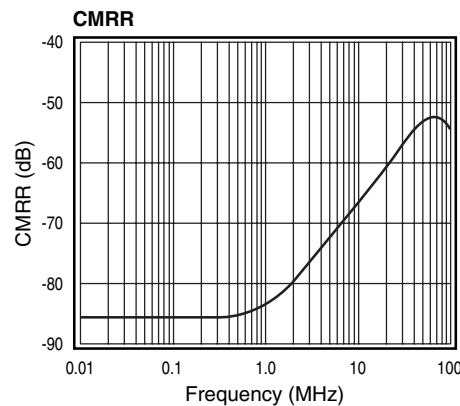
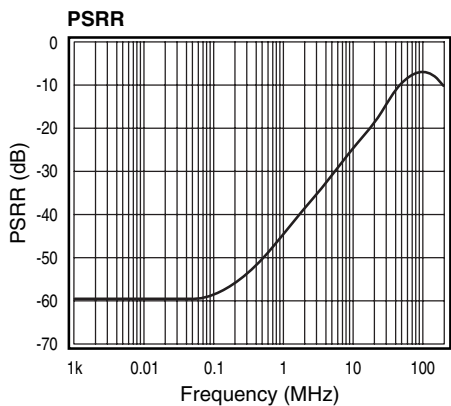
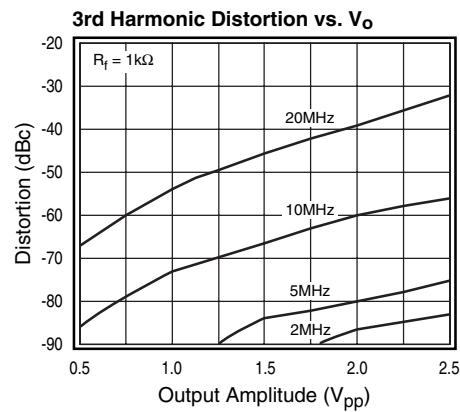
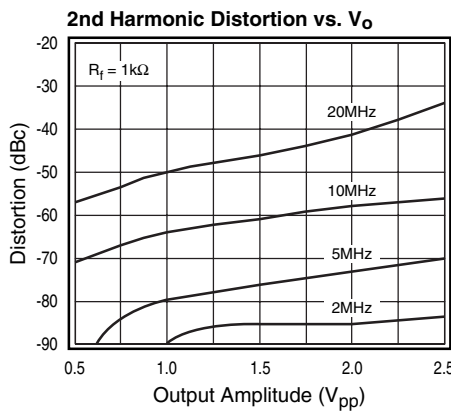
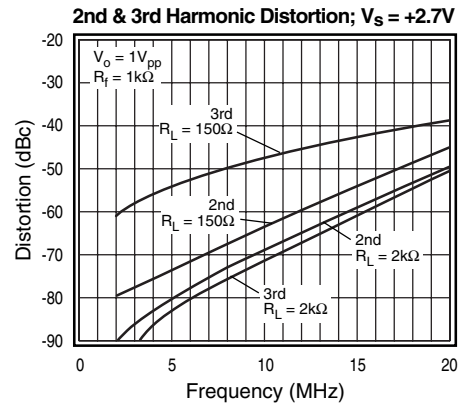
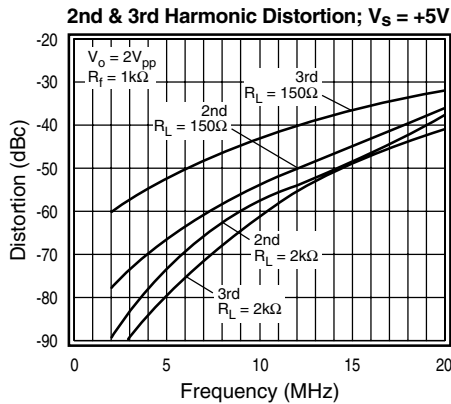

KM4200 Performance Characteristics ($V_s = +5V$, $G = 2$, $R_f = 2k\Omega$, $R_L = 2k\Omega$ to $V_s/2$; unless noted)

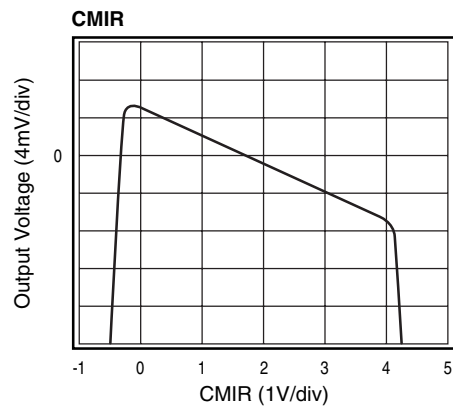
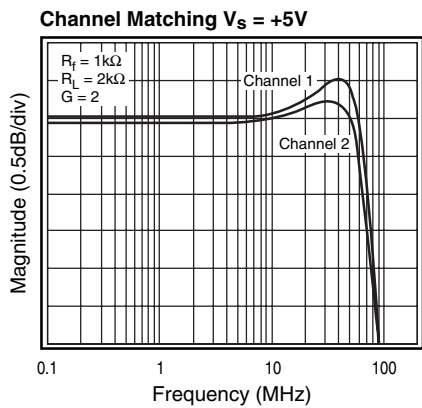
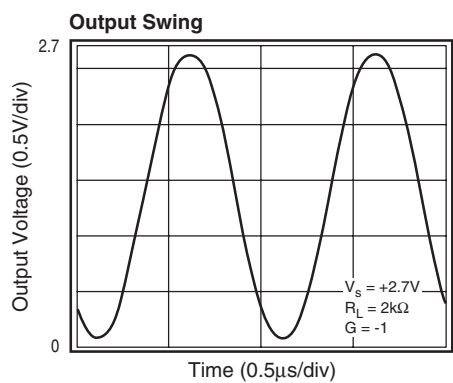
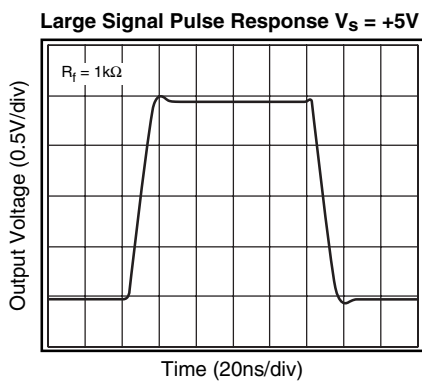
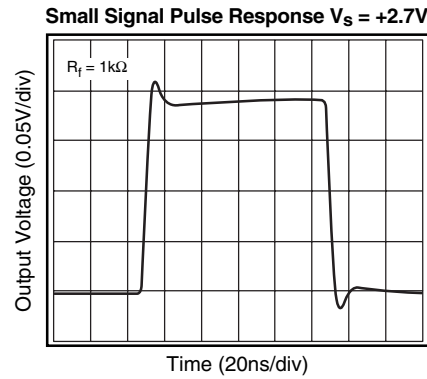
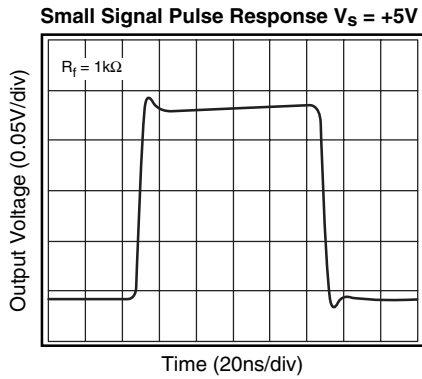

General Description

The KM4200 is a single supply, general purpose, voltage-feedback amplifier fabricated on a complementary bipolar process using a patent pending topography. It features a rail-to-rail output stage and is unity gain stable. Both gain bandwidth and slew rate are insensitive to temperature.

The common mode input range extends to 300mV below ground and to 1.2V below V_s . Exceeding these values will not cause phase reversal. However, if the input voltage exceeds the rails by more than 0.5V, the input ESD devices will begin to conduct. The output will stay at the rail during this overdrive condition.

The design uses a Darlington output stage. The output stage is short circuit protected and offers "soft" saturation protection that improves recovery time.

The typical circuit schematic is shown in Figure 1.

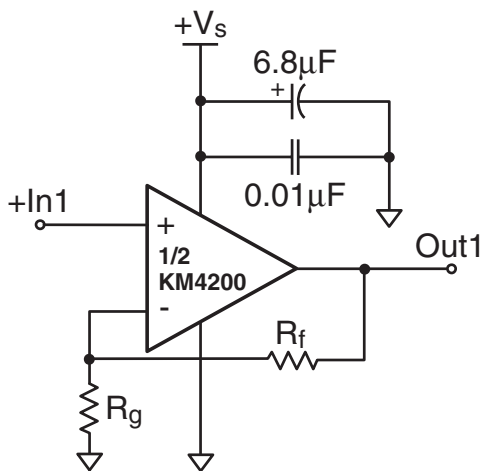

Figure 1: Typical Configuration

At non-inverting gains other than $G = +1$, keep R_g below $1k\Omega$ to minimize peaking; thus, for optimum response at a gain of +2, a feedback resistor of $1k\Omega$ is recommended. Figure 2 illustrates the KM4200 frequency response with both $1k\Omega$ and $2k\Omega$ feedback resistors.

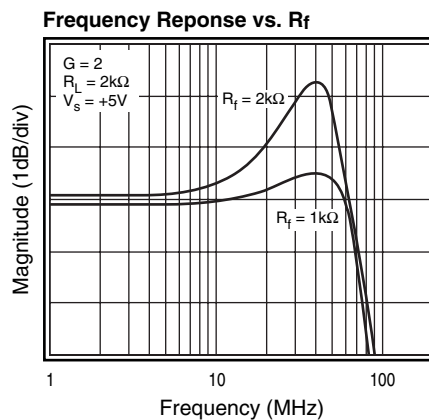

Figure 2: Frequency Response vs. R_f

Power Dissipation

The maximum internal power dissipation allowed is directly related to the maximum junction temperature. If the maximum junction temperature exceeds 150°C , some reliability degradation will occur. If the maximum junction temperature exceeds 175°C for an extended time, device failure may occur.

The KM4200 is short circuit protected. However, this may not guarantee that the maximum junction temperature ($+150^\circ\text{C}$) is not exceeded under all conditions. Follow the maximum power derating curves shown in Figure 3 to ensure proper operation.

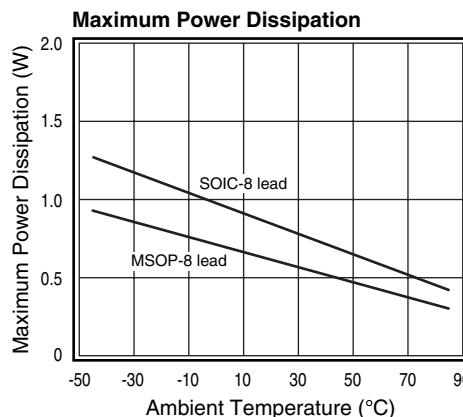

Figure 3: Power Derating Curves

Overdrive Recovery

For an amplifier, an overdrive condition occurs when the output and/or input ranges are exceeded. The recovery time varies based on whether the input or output is overdriven and by how much the ranges are exceeded. The KM4200 will typically recover in less than 20ns from an overdrive condition. Figure 4 shows the KM4200 in an overdriven condition.

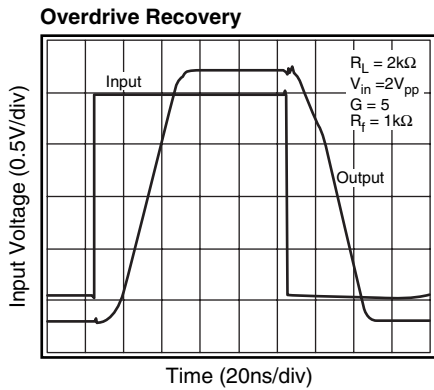

Figure 4: Overdrive Recovery

Driving Capacitive Loads

The Frequency Response vs. C_L plot on page 4, illustrates the response of the KM4200. A small series resistance (R_s) at the output of the amplifier, illustrated in Figure 5, will improve stability and settling performance. R_s values in the Frequency Response vs. C_L plot were chosen to achieve maximum bandwidth with less than 1dB of peaking. For maximum flatness, use a larger R_s .

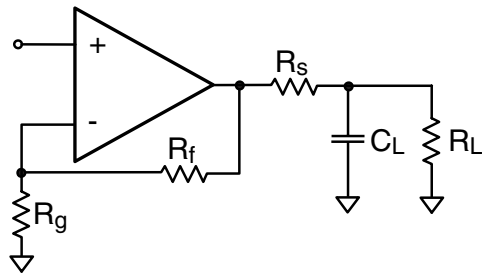

Figure 5: Typical Topology for driving a capacitive load

Layout Considerations

General layout and supply bypassing play major roles in high frequency performance. Fairchild has evaluation boards to use as a guide for high frequency layout and to aid in device testing and characterization. Follow the steps below as a basis for high frequency layout:

- Include 6.8 μ F and 0.01 μ F ceramic capacitors
- Place the 6.8 μ F capacitor within 0.75 inches of the power pin
- Place the 0.01 μ F capacitor within 0.1 inches of the power pin
- Remove the ground plane under and around the part, especially near the input and output pins to reduce parasitic capacitance
- Minimize all trace lengths to reduce series inductances

Refer to the evaluation board layouts shown in Figure 7 for more information.

When evaluating only one channel, complete the following on the unused channel

1. Ground the non-inverting input
2. Short the output to the inverting input

Evaluation Board Information

The following evaluation boards are available to aid in the testing and layout of this device:

Eval Board	Description	Products
KEB006	Dual Channel, Dual Supply 8 lead SOIC	KM4200IC8
KEB010	Dual Channel, Dual Supply 8 lead MSOP	KM4200IM8

Evaluation board schematics and layouts are shown in Figure 6 and Figure 7.

The KEB006 evaluation board is built for dual supply operation. Follow these steps to use the board in a single supply application:

1. Short $-V_s$ to ground
2. Use C3 and C4, if the $-V_s$ pin of the KM4200 is not directly connected to the ground plane.

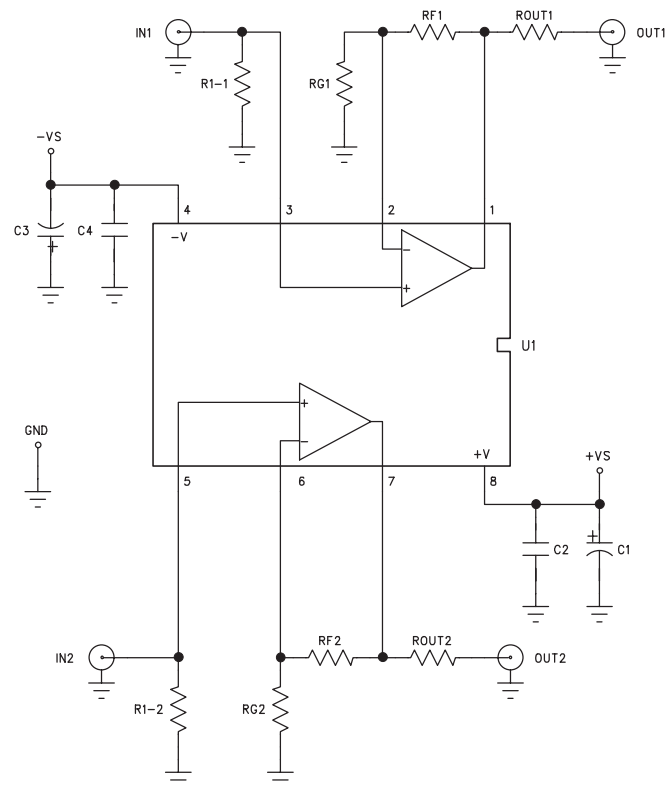

Figure 6: Evaluation Board Schematic

KM4200 Evaluation Board Layout

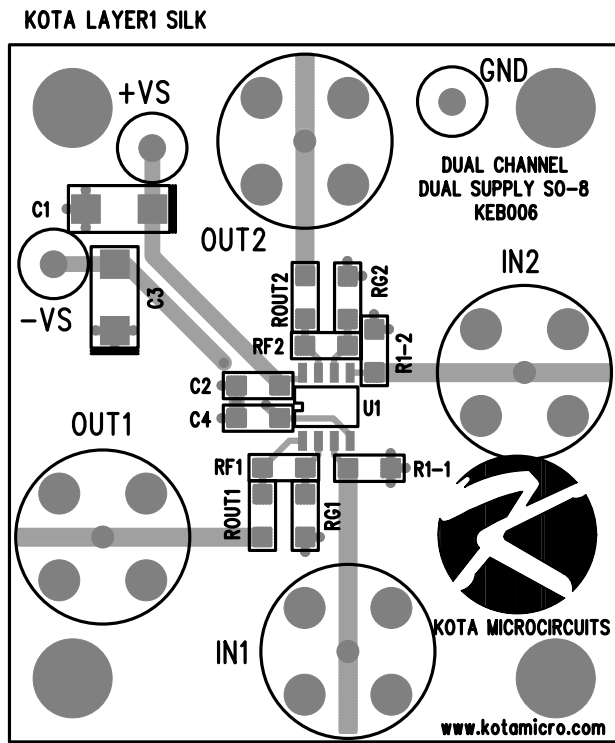

Figure 7a: KEB006 (top side)

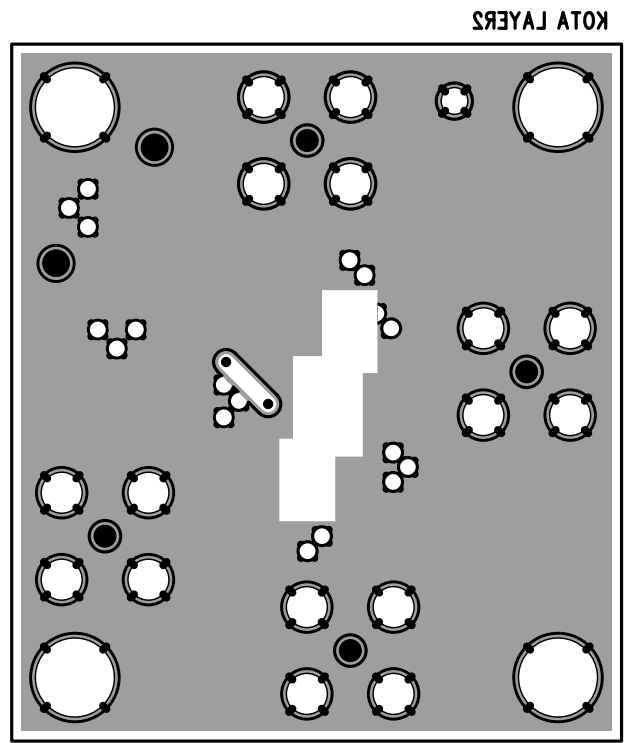

Figure 7b: KEB006 (bottom side)

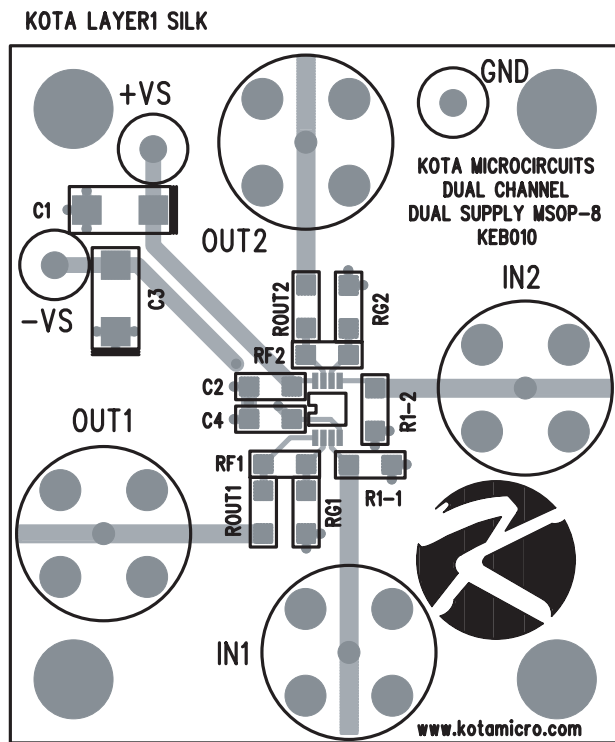

Figure 7c: KEB010 (top side)

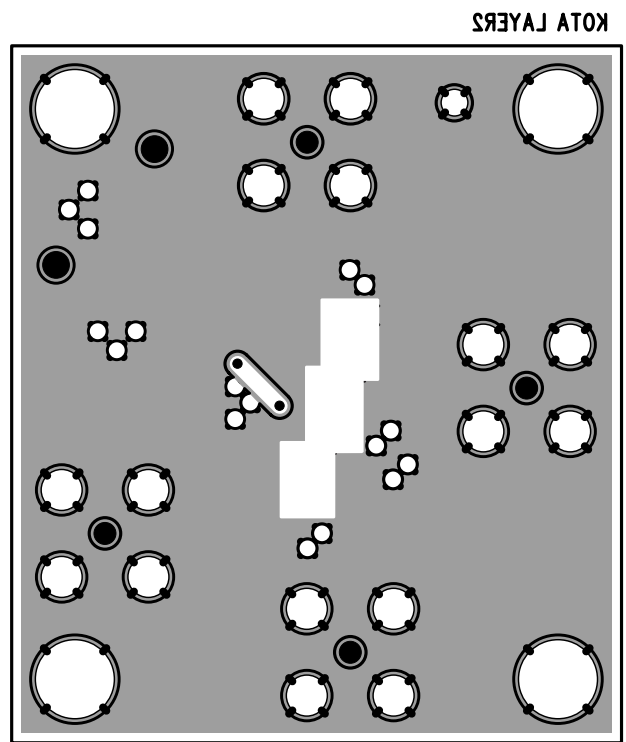
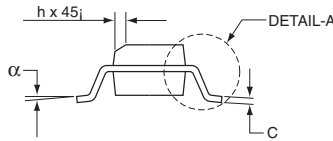
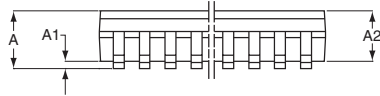
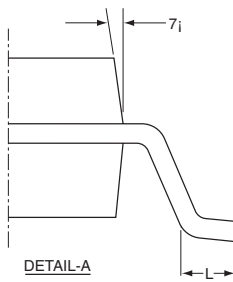
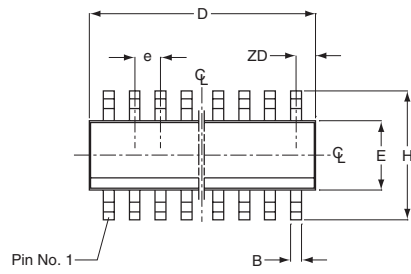

Figure 7d: KEB010 (bottom side)

KM4200 Package Dimensions

SOIC



SOIC-8		
SYMBOL	MIN	MAX
A1	0.10	0.25
B	0.36	0.46
C	0.19	0.25
D	4.80	4.98
E	3.81	3.99
e	1.27 BSC	
H	5.80	6.20
h	0.25	0.50
L	0.41	1.27
A	1.52	1.72
	0°	8°
ZD	0.53 ref	
A2	1.37	1.57

NOTE:

- All dimensions are in millimeters.
- Lead coplanarity should be 0 to 0.10mm (.004") max.
- Package surface finishing:
 (2.1) Top: matte (charmillies #18-30).
 (2.2) All sides: matte (charmillies #18-30).
 (2.3) Bottom: smooth or matte (charmillies #18-30).
- All dimensions excluding mold flashes and end flash from the package body shall not exceed 0.152mm (.006) per side(d).

MSOP

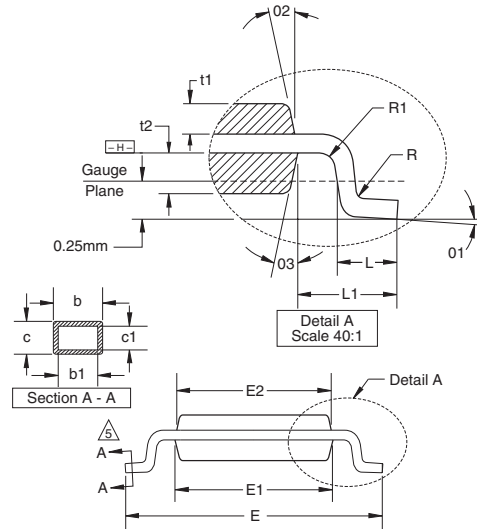
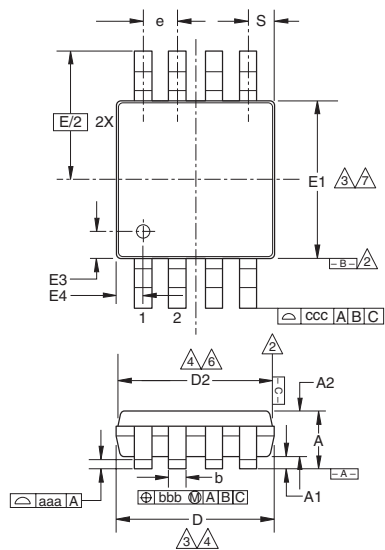

MSOP-8		
SYMBOL	MIN	MAX
A	1.10	-
A1	0.10	±0.05
A2	0.86	±0.08
D	3.00	±0.10
D2	2.95	±0.10
E	4.90	±0.15
E1	3.00	±0.10
E2	2.95	±0.10
E3	0.51	±0.13
E4	0.51	±0.13
R	0.15	+0.15/-0.06
R1	0.15	+0.15/-0.06
t1	0.31	±0.08
t2	0.41	±0.08
b	0.33	+0.07/-0.08
b1	0.30	±0.05
c	0.18	±0.05
c1	0.15	+0.03/-0.02
01	3.0°	±3.0°
02	12.0°	±3.0°
03	12.0°	±3.0°
L	0.55	±0.15
L1	0.95 BSC	-
aaa	0.10	-
bbb	0.08	-
ccc	0.25	-
e	0.65 BSC	-
S	0.525 BSC	-

NOTE:

- All dimensions are in millimeters (angle in degrees), unless otherwise specified.
- Datums $\square B \square$ and $\square C \square$ to be determined at datum plane $\square H \square$.
- Dimensions "D" and "E1" are to be determined at datum $\square H \square$.
- Dimensions "D2" and "E2" are for top package and dimensions "D" and "E1" are for bottom package.
- Cross sections A - A to be determined at 0.13 to 0.25mm from the leadtip.
- Dimension "D" and "D2" does not include mold flash, protrusion or gate burrs.
- Dimension "E1" and "E2" does not include interlead flash or protrusion.

Ordering Information

Model	Part Number	Package	Container	Pack Qty
KM4200	KM4200IC8	SOIC-8	Rail	95
	KM4200IC8TR3	SOIC-8	Reel	2500
	KM4200IM8	MSOP-8	Rail	50
	KM4200IM8TR3	MSOP-8	Reel	4000

Temperature range for all parts: -40°C to +85°C.

DISCLAIMER

FAIRCHILD SEMICONDUCTOR RESERVES THE RIGHT TO MAKE CHANGES WITHOUT FURTHER NOTICES TO ANY PRODUCTS HEREIN TO IMPROVE RELIABILITY, FUNCTION OR DESIGN. FAIRCHILD DOES NOT ASSUME ANY LIABILITY ARISING OUT OF THE APPLICATION OR USE OF ANY PRODUCT OR CIRCUIT DESCRIBED HEREIN; NEITHER DOES IT CONVEY ANY LICENSE UNDER ITS PATENT RIGHTS, NOR THE RIGHTS OF OTHERS.

LIFE SUPPORT POLICY

FAIRCHILD'S PRODUCTS ARE NOT AUTHORIZED FOR USE AS CRITICAL COMPONENTS IN LIFE SUPPORT DEVICES OR SYSTEMS WITHOUT THE EXPRESS WRITTEN APPROVAL OF THE PRESIDENT OF FAIRCHILD SEMICONDUCTOR CORPORATION. As used herein:

1. Life support devices or systems are devices or systems which, (a) are intended for surgical implant into the body, or (b) support or sustain life, and (c) whose failure to perform when properly used in accordance with instructions for use provided in the labeling, can be reasonably expected to result in a significant injury of the user.
2. A critical component in any component of a life support device or system whose failure to perform can be reasonably expected to cause the failure of the life support device or system, or to affect its safety or effectiveness.