

PTF 10043

12 Watts, 1.9–2.0 GHz

GOLDMOS® Field Effect Transistor

Description

The PTF 10043 is an internally matched GOLDMOS FET intended for large signal amplifier applications from 1.9 to 2.0 GHz. Rated at 12 watts, it operates at 45% efficiency with 12 dB gain. Nitride surface passivation and full gold metallization ensure excellent device lifetime and reliability.

- **INTERNALLY MATCHED**
- **Performance at 2.0 GHz, 26 Volts**
 - Output Power = 12 Watts Min
 - Power Gain = 12 dB Typ at 3 Watts
 - Efficiency = 45% Typ
- **Full Gold Metallization**
- **Silicon Nitride Passivated**
- **Back Side Common Source**
- **Excellent Thermal Stability**
- **100% Lot Traceability**

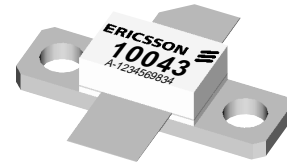
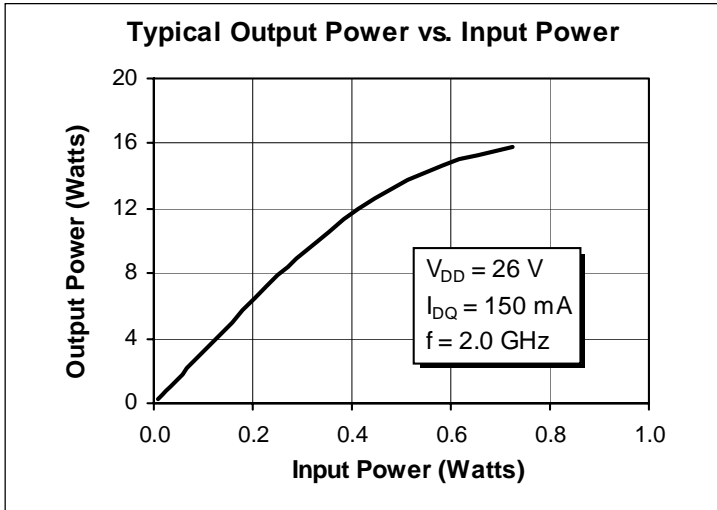

Package 20222

RF Specifications (100% Tested)

Characteristic	Symbol	Min	Typ	Max	Units
Gain ($V_{DD} = 26\text{ V}$, $P_{OUT} = 3\text{ W}$, $I_{DQ} = 150\text{ mA}$, $f = 1.93, 2.0\text{ GHz}$)	G_{ps}	11	12	—	dB
Power Output at 1 dB Compressed ($V_{DD} = 26\text{ V}$, $P_{OUT} = 12\text{ W}$, $I_{DQ} = 150\text{ mA}$, $f = 2.0\text{ GHz}$)	p-1dB	12	14	—	Watts
Drain Efficiency ($V_{DD} = 26\text{ V}$, $P_{OUT} = 12\text{ W}$, $I_{DQ} = 150\text{ mA}$, $f = 2.0\text{ GHz}$)	η_D	40	45	—	%
Load Mismatch Tolerance ($V_{DD} = 26\text{ V}$, $P_{OUT} = 12\text{ W}$, $I_{DQ} = 150\text{ mA}$, $f = 2.0\text{ GHz}$ —all phase angles at frequency of test)	Ψ	—	—	10:1	—

All published data at $T_{CASE} = 25^\circ\text{C}$ unless otherwise indicated.

Electrical Characteristics (100% Tested)

Characteristic	Conditions	Symbol	Min	Typ	Max	Units
Drain-Source Breakdown Voltage	$V_{GS} = 0\text{ V}, I_D = 5\text{ mA}$	$V_{(BR)DSS}$	65	—	—	Volts
Zero Gate Voltage Drain Current	$V_{DS} = 26\text{ V}, V_{GS} = 0\text{ V}$	I_{DSS}	—	—	1.0	mA
Gate Threshold Voltage	$V_{DS} = 10\text{ V}, I_D = 75\text{ mA}$	$V_{GS(th)}$	3.0	—	5.0	Volts
Forward Transconductance	$V_{DS} = 10\text{ V}, I_D = 2\text{ A}$	g_{fs}	—	0.8	—	Siemens

Maximum Ratings

Parameter	Symbol	Value	Unit
Drain-Source Voltage	V_{DSS}	65	Vdc
Gate-Source Voltage	V_{GS}	± 20	Vdc
Operating Junction Temperature	T_J	200	$^{\circ}\text{C}$
Total Device Dissipation Above 25°C derate by	P_D	55 0.31	Watts $\text{W}/^{\circ}\text{C}$
Storage Temperature Range	T_{STG}	-40 to +150	$^{\circ}\text{C}$
Thermal Resistance ($T_{CASE} = 70^{\circ}\text{C}$)	$R_{\theta JC}$	3.2	$^{\circ}\text{C}/\text{W}$

Typical Performance

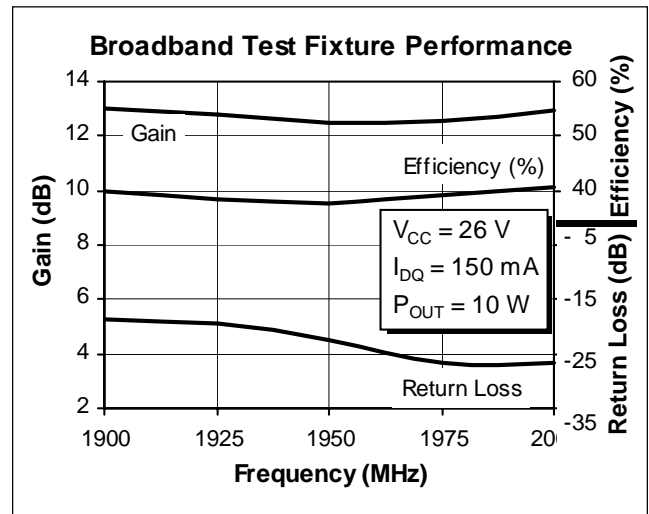
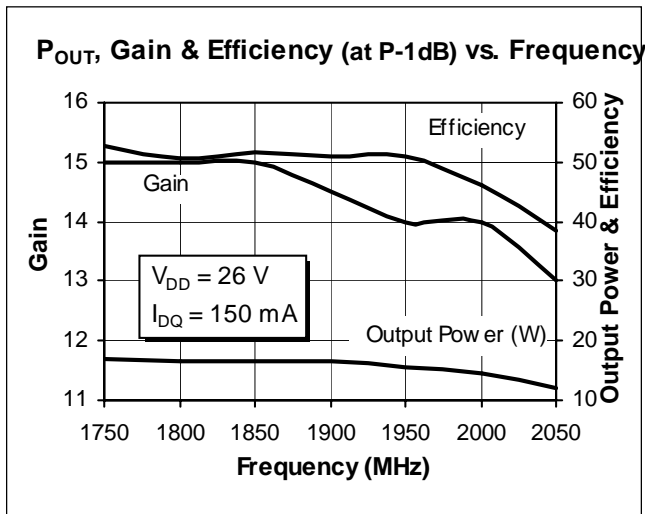

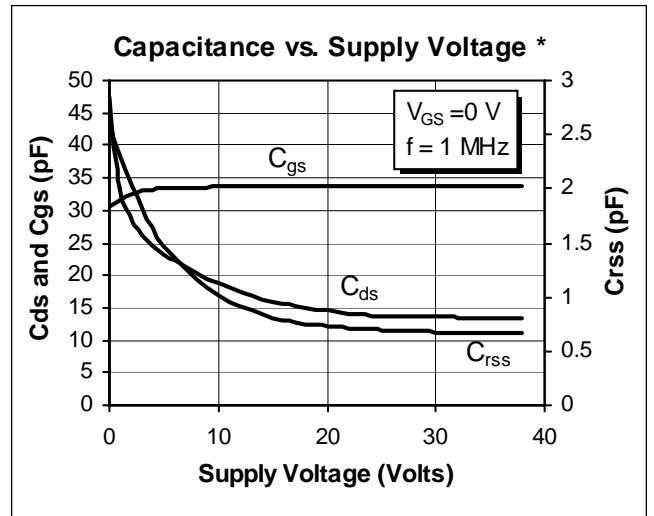
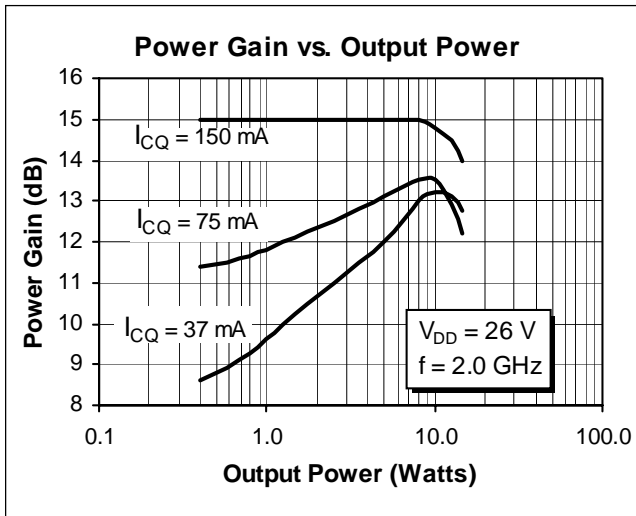
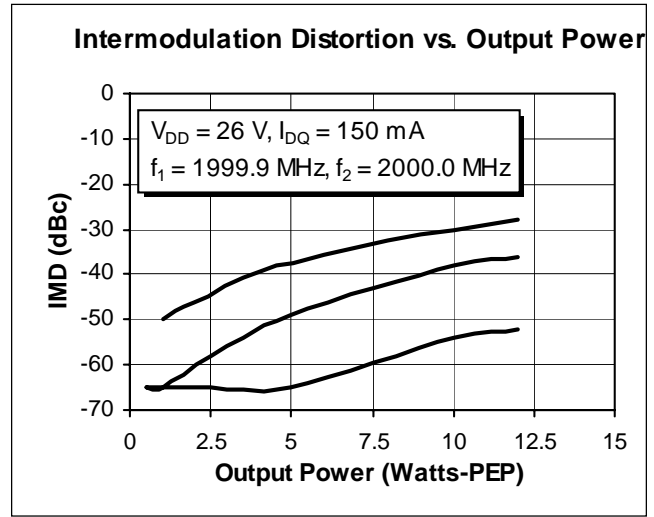
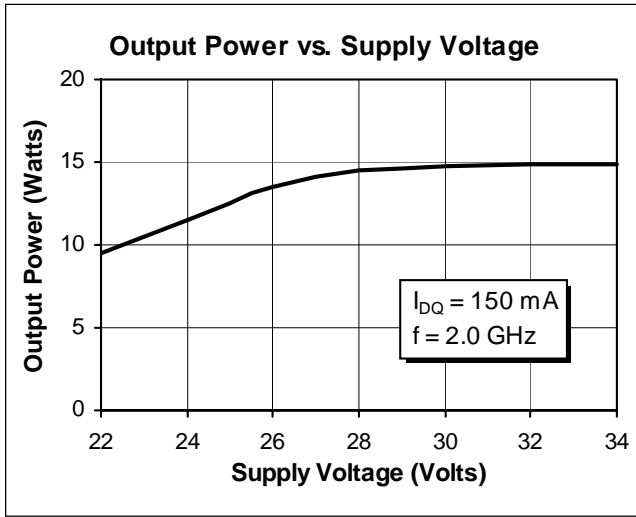

*This part is internally matched. Measurements of the finished product will not yield these figures.

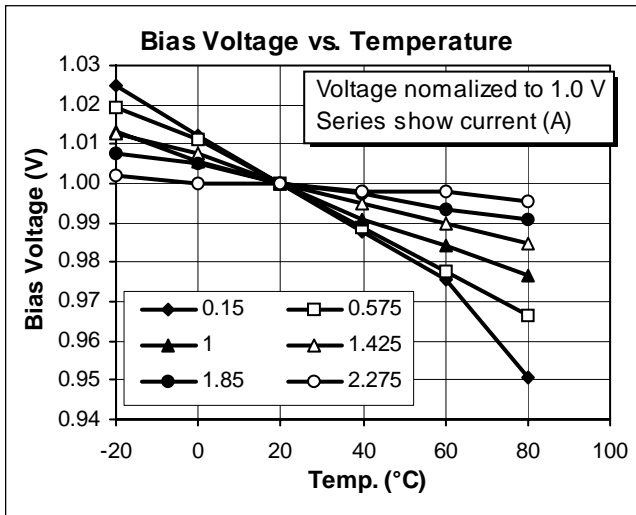

Impedance Data

$V_{DS} = 26\text{ V}$, $P_{OUT} = 12\text{ W}$, $I_{DQ} = 150\text{ mA}$

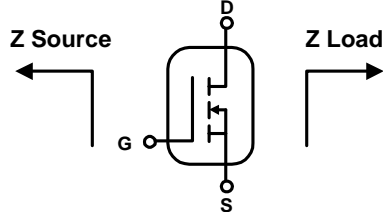

Frequency GHz	Z Source Ω		Z Load Ω	
	R	jX	R	jX
1.75	2.8	-2.4	3.2	1.9
1.80	3.2	-2.7	3.0	1.5
1.85	3.0	-3.2	2.7	0.9
1.90	2.5	-3.1	2.4	0.4
1.95	2.3	-2.8	2.2	0.0
2.00	2.2	-2.5	1.9	-0.6
2.05	2.3	-2.3	1.7	-1.1

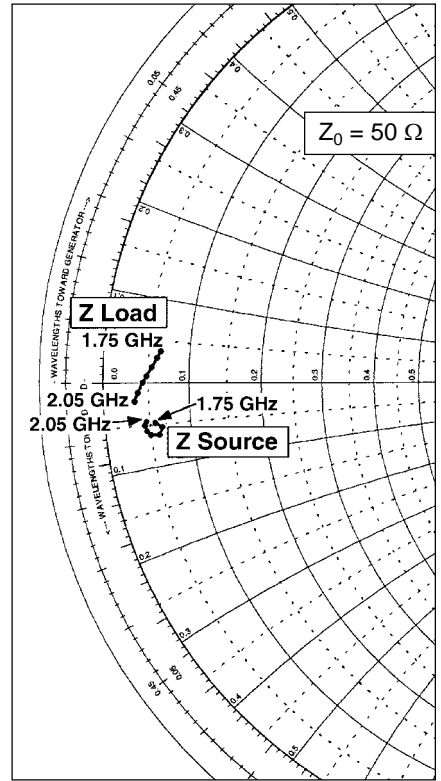

Typical Scattering Parameters

$(V_{DS} = 28\text{ V}$, $I_D = 500\text{ mA})$

f (MHz)	S11		S21		S12		S22	
	Mag	Ang	Mag	Ang	Mag	Ang	Mag	Ang
100	0.912	-143	14.7	86	0.007	0	0.641	-70
200	0.917	-150	11.5	80	0.006	-5	0.650	-82
300	0.951	-163	5.83	53	0.004	-16	0.750	-107
400	0.964	-168	3.71	39	0.002	0	0.824	-122
500	0.971	-171	2.63	28	0.002	65	0.881	-132
600	0.974	-174	1.99	20	0.003	94	0.931	-139
700	0.975	-175	1.56	12	0.006	98	0.952	-146
800	0.975	-177	1.26	6	0.008	95	0.950	-151
900	0.980	-178	1.07	0	0.010	93	0.951	-155
1000	0.979	-179	0.932	-5	0.012	92	0.948	-158
1100	0.981	180	0.846	-11	0.014	89	0.959	-160
1200	0.977	179	0.790	-16	0.015	86	0.965	-162
1300	0.975	177	0.763	-23	0.017	83	0.970	-164
1400	0.965	176	0.759	-30	0.019	82	0.972	-166
1500	0.951	175	0.782	-39	0.021	80	0.974	-168
1600	0.929	174	0.828	-51	0.023	78	0.975	-169
1700	0.904	174	0.880	-68	0.025	74	0.986	-170
1800	0.885	175	0.884	-89	0.027	70	1.00	-171
1900	0.892	177	0.802	-113	0.029	67	1.02	-173
2000	0.918	177	0.650	-134	0.030	61	1.02	-175
2100	0.942	177	0.489	-151	0.028	54	1.01	-177
2200	0.964	176	0.366	-162	0.025	56	1.01	-178

Test Circuit

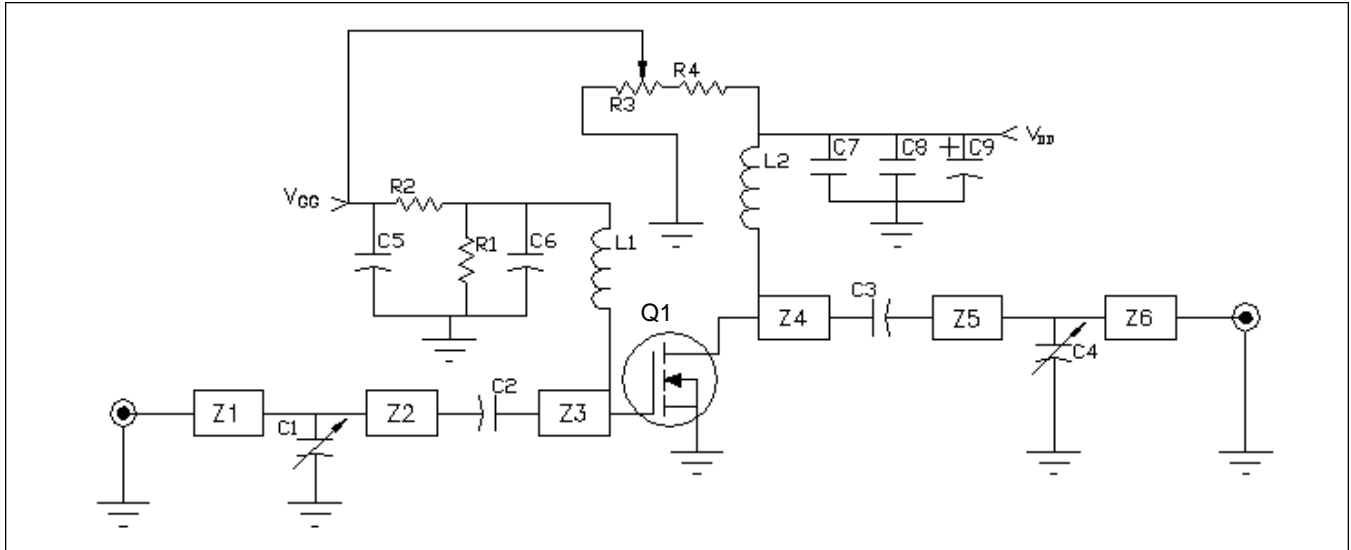

Block Diagram for $f = 2.0$ GHz

Q1	PTF 10043	RF LDMOS FET
Z1, Z6	50 Ω	Microstrip
Z2, Z5	50 Ω , 0.085 λ	Microstrip
Z3	7.5 Ω , 0.154 λ	Microstrip
Z4	7.9 Ω , 0.238 λ	Microstrip
C1, C4	0.3–3.5	Trim Capacitor
C2, C3, C6, C8	33 pF	Capacitor ATCB
C5, C7	0.1 μ F, 50 V	Capacitor Digi-Key P4917-ND
C9	100 μ F, 50V	Electrolytic Capacitor Digi-Key P5276
L1, L2	#20 AWG	3 Turn, 0.12" I.D.
R1, R2	500 Ω	Resistor
Circuit Board	.031" thick, $\epsilon_r = 4.0$, G200, AlliedSignal, 2 oz. copper	

<i>Bias Parts (not shown on layout)</i>		
R3	2 K	Potentiometer
R4	10 Ω	Resistor

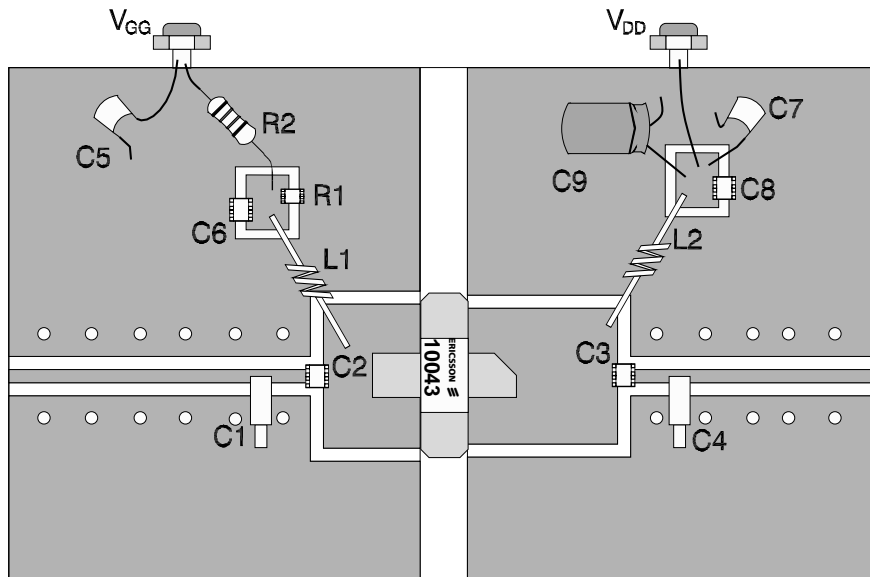

Parts Layout (not to scale)

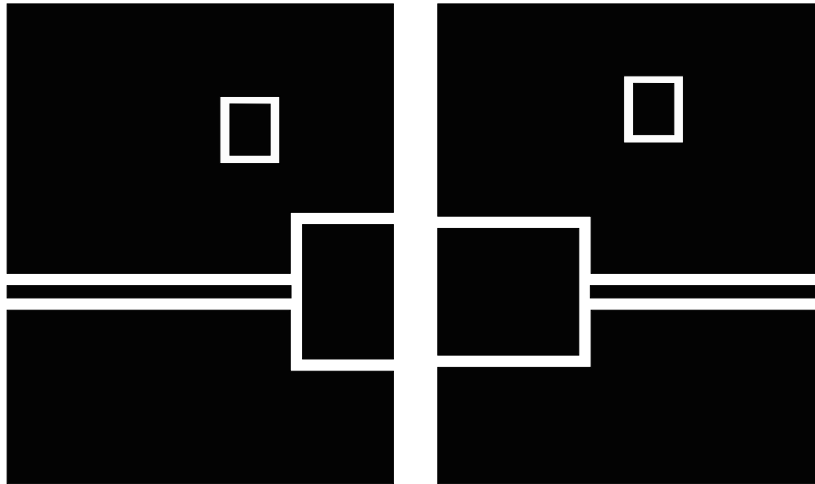

Artwork (not to scale)

Package Mechanical Specifications

